

Pull-up Resistor Integrated Hall Effect Latch

DESCRIPTION

TSH193 Hall-effect sensor is a temperature stable, stress-resistant sensor. Superior high-temperature performance is made possible through a dynamic offset cancellation that utilizes chopper-stabilization. This method reduces the offset voltage normally caused by device over molding, temperature dependencies, and thermal stress.

TSH193 includes the following on a single silicon chip: voltage regulator, Hall voltage generator, small-signal amplifier, chopper stabilization, Schmitt trigger, Pull-up resistor output. Advanced DMOS wafer fabrication processing is used to take advantage of low-voltage requirements, component matching, very low input-offset errors, and small component geometries.

This device requires the presence of both south and north polarity magnetic fields for operation. In the presence of a south polarity field of sufficient strength, the device output sensor on, and only switches off when a north polarity field of sufficient strength is present.

FEATURES

- Chopper stabilized amplifier stage.
- Optimized for BLDC motor applications.
- Reliable and low shifting on high Temp condition.
- Pull-up resistor integrated
- ESD Protection >4kV HBM
- Compliant to RoHS Directive 2011/65/EU and in accordance to WEEE 2002/96/EC
- Halogen-free according to IEC 61249-2-21 definition

APPLICATION

- High temperature fan motor
- 3 phase BLDC motor application
- Speed sensing, position sensing
- Revolution counting
- Solid-state switch
- Angular position detection
- Proximity detection



TO-92S

Pin Definition:

1. V_{CC}
2. Ground
3. Output



SOT-23

Pin Definition:

1. V_{CC}
2. Output
3. Ground

Notes: Moisture sensitivity level: level 3. Per J-STD-020

TYPICAL APPLICATION CIRCUIT

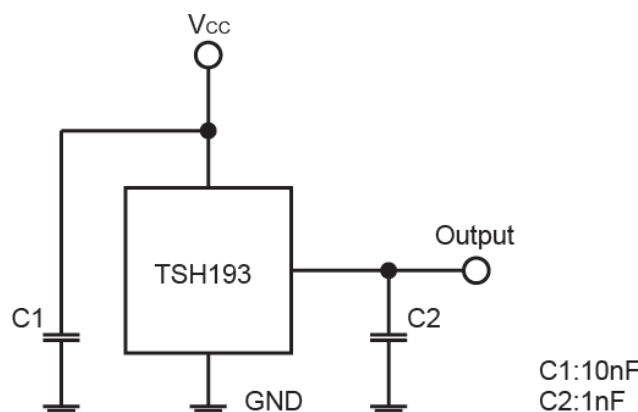

ABSOLUTE MAXIMUM RATINGS ($T_A = 25^\circ\text{C}$ unless otherwise noted)			
PARAMETER	SYMBOL	LIMIT	UNIT
Supply voltage	V_{CC}	18	V
Output current	I_{OUT}	13	mA
Magnetic flux density		Unlimited	Gauss
Operating Temperature Range	T_{OPR}	-40 to +125	$^\circ\text{C}$
Storage temperature range	T_{STG}	-55 to +150	$^\circ\text{C}$
Maximum Junction Temperature	T_J	150	$^\circ\text{C}$
Package Power Dissipation	TO-92S	606	mW
	SOT-23	230	

THERMAL PERFORMANCE			
PARAMETER	SYMBOL	LIMIT	UNIT
Thermal Resistance - Junction to Case	TO-92S	206	$^\circ\text{C/W}$
	SOT-23	543	
Thermal Resistance - Junction to Ambient	TO-92S	148	$^\circ\text{C/W}$
	SOT-23	410	

Note: Considering 6 cm² of copper board heat-sink

ELECTRICAL SPECIFICATIONS					
(DC Operating Parameters : $T_A = +25^\circ\text{C}$, $V_{CC} = 12\text{V}$)					
PARAMETER	CONDITIONS	MIN	TYP	MAX	UNIT
Supply Voltage	Operating	2.5	--	16	V
Supply Current	$B < B_{OP}$	--	--	5	mA
Output Saturation Voltage	$B > B_{OP}$	--	--	400	mV
Output Leakage Current	I_{OFF} $B < B_{RP}$, $V_{OUT} = 12\text{V}$	--	--	10	μA
Output Rise Time	$R_L = 1.1\text{k}\Omega$, $C_L = 20\text{pF}$	--	0.04	0.45	μs
Output Fall Time	$R_L = 820\Omega$; $C_L = 20\text{pF}$	--	0.18	0.45	μs
ESD	HBM	4	--	--	kV
Pull-up Resistor		--	10	--	k Ω
Operate Point (B_{OP})		5	--	25	Gauss
Release Point (B_{RP})		-25	--	-5	Gauss
Hysteresis ($B_{OP} - B_{RP}$)		--	30	--	Gauss

Note: 1G (gauss) = 0.1mT (millitesla)

ORDERING INFORMATION

PART NO.	PACKAGE	PACKING
TSH193CT B0G	TO-92S	1kpcs / Bag
TSH193CX RFG	SOT-23	3kpcs / 7"Reel

OUTPUT BEHAVIOR VERSUS MAGNETIC POLE

DC Operating Parameters: $T_A = -40$ to 125°C , $V_{CC} = 2.5\sim 18\text{V}$

Parameter	Test condition	OUT (TO-92S)	OUT (SOT-23)
North pole	$B > B_{OP}$	Hi	Low
South pole	$B < B_{RP}$	Low	Hi

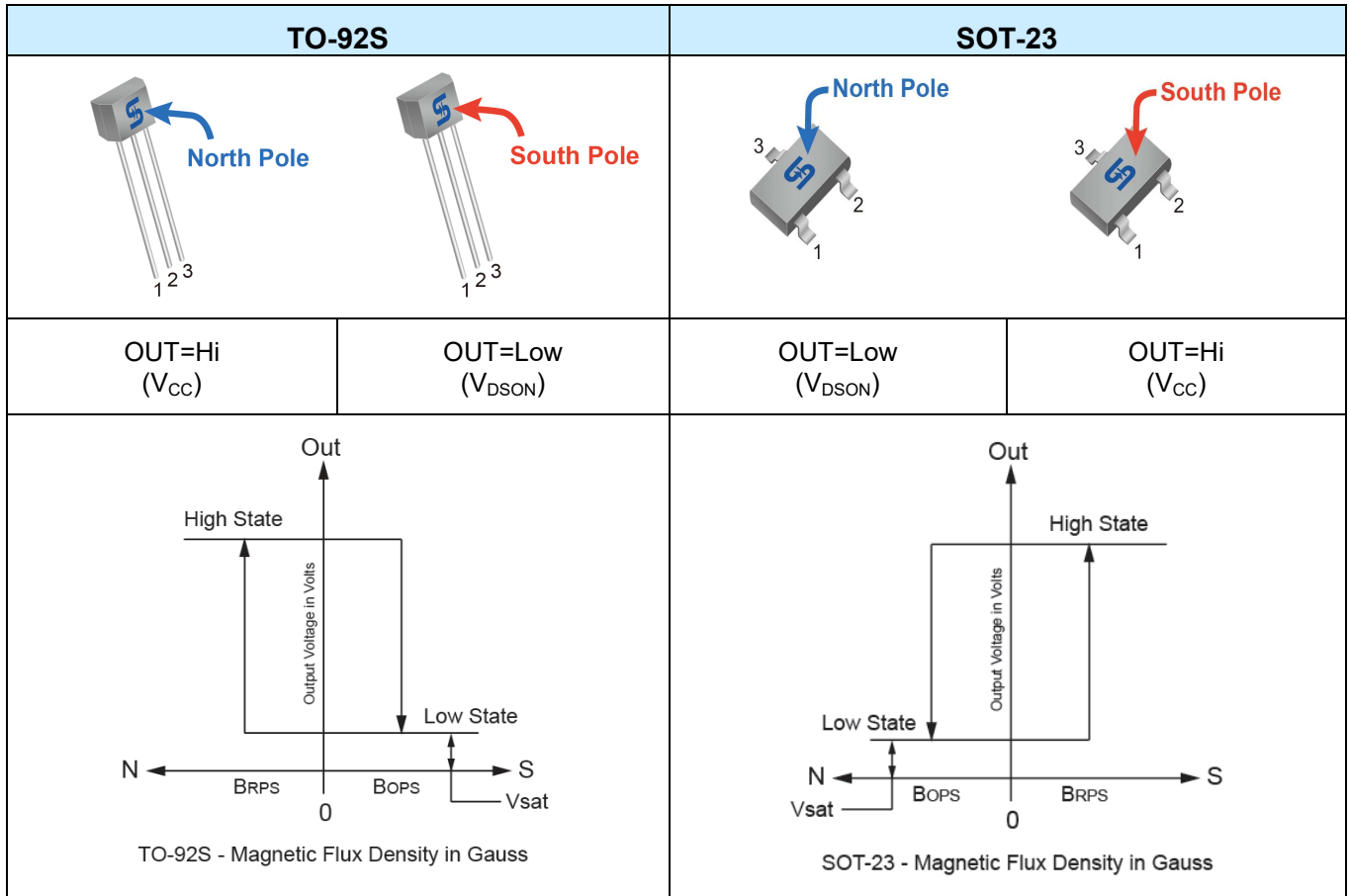

CHARACTERISTICS CURVES

($T_c = 25^\circ\text{C}$ unless otherwise noted)

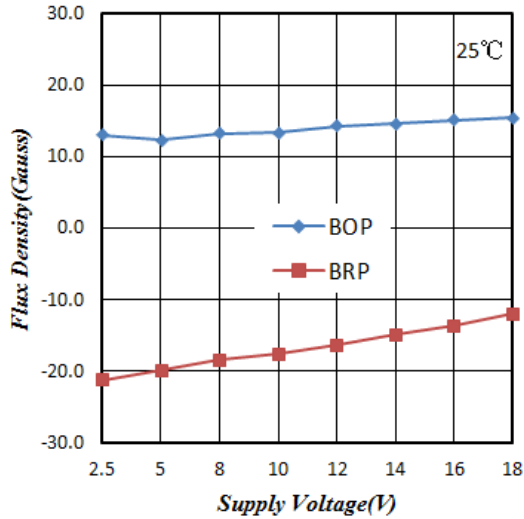

Figure 1. Flux Density vs. Supply Voltage

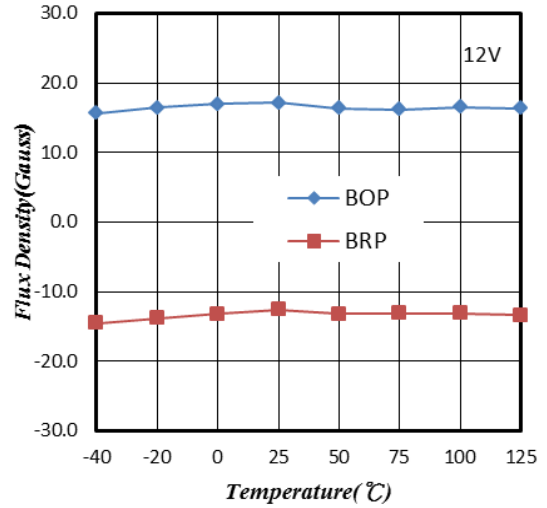

Figure 2. Flux Density vs. Temperature

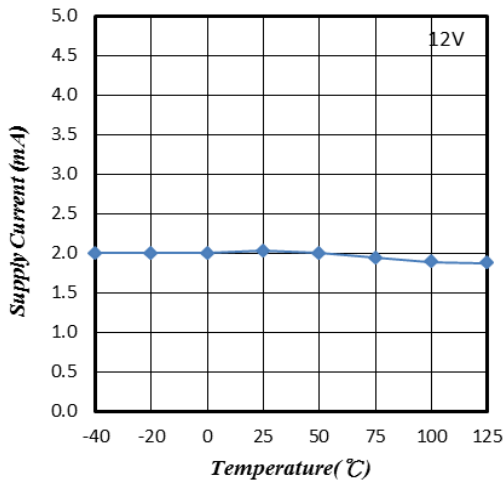

Figure 3. Supply Current vs. Temperature

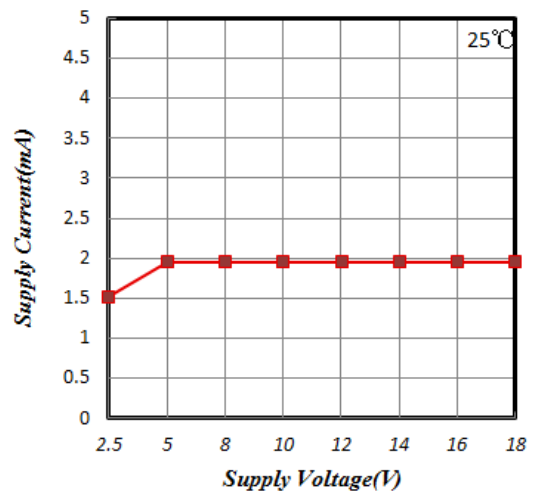

Figure 4. Supply Current vs. Supply Voltage

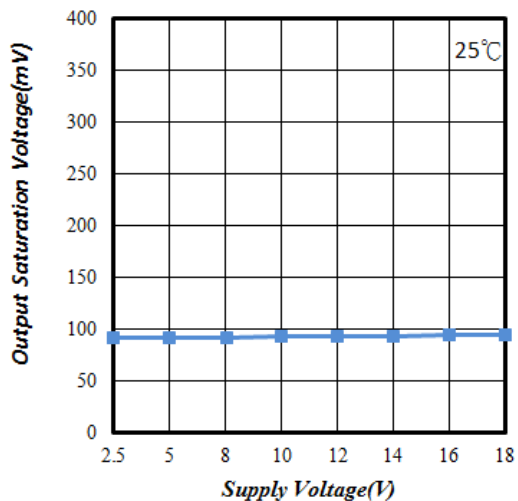

Figure 5. Saturation Voltage vs. Supply Voltage

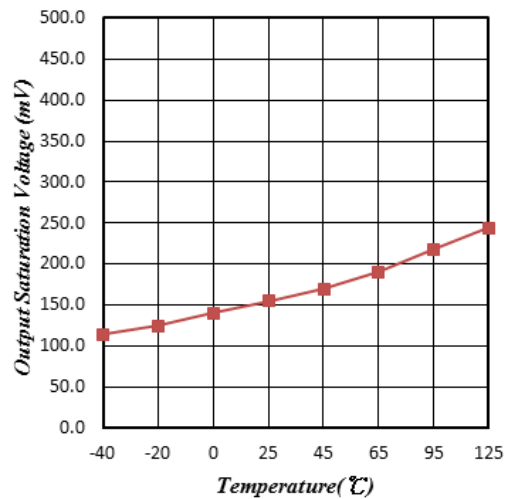

Figure 6. Saturation Voltage vs. Temperature

CHARACTERISTICS CURVES

($T_c = 25^\circ\text{C}$ unless otherwise noted)

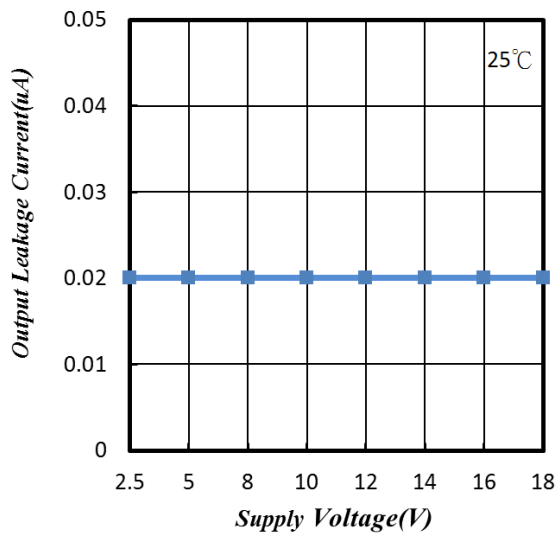

Figure 7. Leakage Current vs. Supply Voltage

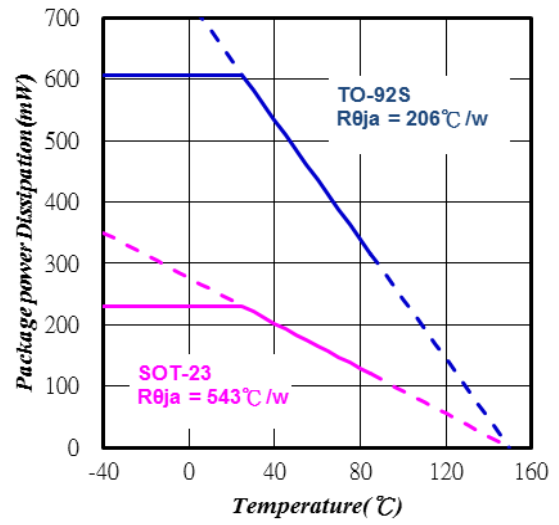
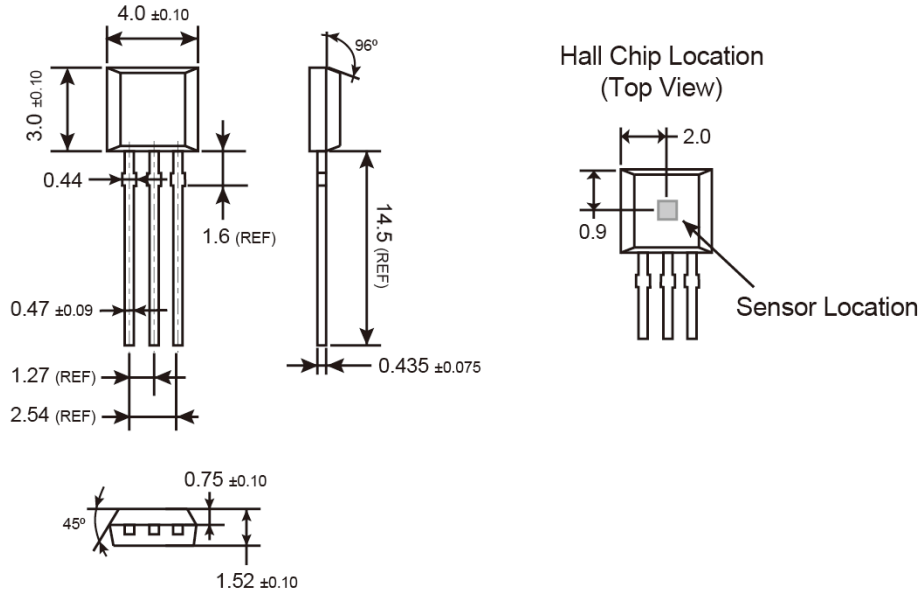

Figure 8. Power Dissipation vs. Temperature

PACKAGE OUTLINE DIMENSIONS (Unit: Millimeters)

TO-92S



MARKING DIAGRAM

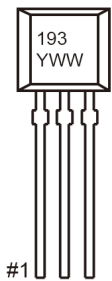

- 193** = Device Code
- Y** = Year Code
- WW** = Week Code (01~52)

PACKAGE OUTLINE DIMENSIONS (Unit: Millimeters)

SOT-23

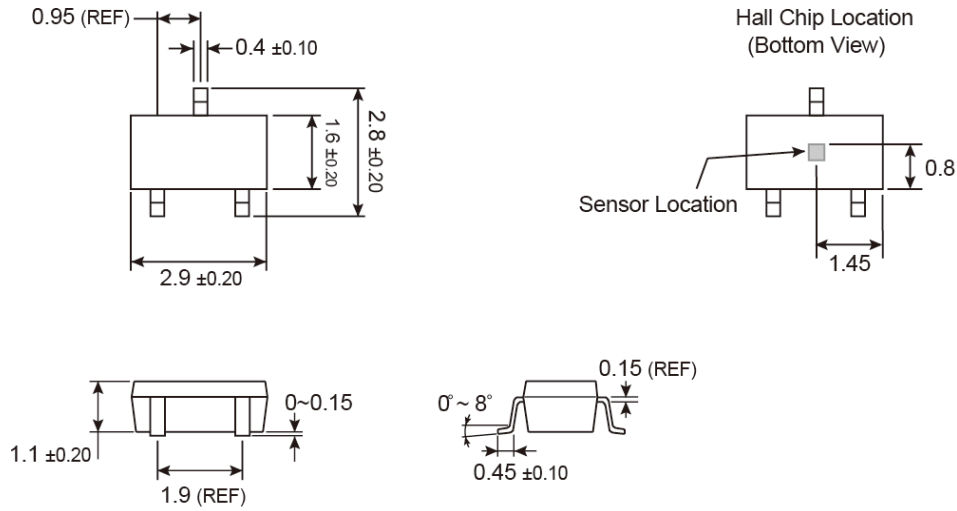

SUGGESTED PAD LAYOUT (Unit: Millimeters)

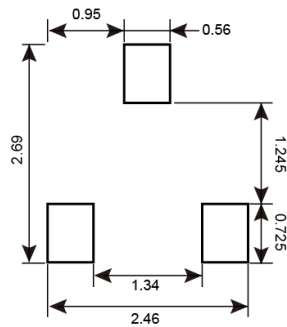

MARKING DIAGRAM

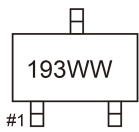

193 = Device Code
WW = Week Code Table

Notice

Specifications of the products displayed herein are subject to change without notice. TSC or anyone on its behalf, assumes no responsibility or liability for any errors or inaccuracies.

Information contained herein is intended to provide a product description only. No license, express or implied, to any intellectual property rights is granted by this document. Except as provided in TSC's terms and conditions of sale for such products, TSC assumes no liability whatsoever, and disclaims any express or implied warranty, relating to sale and/or use of TSC products including liability or warranties relating to fitness for a particular purpose, merchantability, or infringement of any patent, copyright, or other intellectual property right.

The products shown herein are not designed for use in medical, life-saving, or life-sustaining applications. Customers using or selling these products for use in such applications do so at their own risk and agree to fully indemnify TSC for any damages resulting from such improper use or sale.