

# Xinger III

## Directional Coupler 20dB



### Description

The X3C19F1-20S is a low profile, high performance 20dB directional coupler in a new easy to use, manufacturing friendly surface mount package. It is designed for AMPS, GSM, WCDMA and LTE band applications. The X3C19F1-20S is designed particularly for balanced power and low noise amplifiers, plus signal distribution and other applications where low insertion loss and tight amplitude and phase balance is required. It can be used in high power applications up to 25 watts.

Parts have been subjected to rigorous qualification testing and they are manufactured using materials with coefficients of thermal expansion (CTE) compatible with common substrates such as FR4, G-10, RF-35, RO4003 and polyimide. Produced with 6 of 6 RoHS compliant tin immersion finish.

### Features:

- 1400-2700 MHz
- AMPS, GSM, WCDMA & LTE
- High Power
- Very Low Loss
- Tight Amplitude Balance
- High Isolation
- Production Friendly
- Tape and Reel
- Lead-Free

### Electrical Specifications \*\*

Frequency	Mean Coupling	Insertion Loss	VSWR	Group Delay (GD-C)
MHz	dB	dB Max	Max : 1	ns
1400-2700	20.0 ±1.5	0.10	1.22	0.12±0.03
1700-2200	20.0 ±1.0	0.05	1.15	0.12±0.03
1805-1880	20.0 ±0.5	0.05	1.12	0.12±0.03
1930-1990	20.0 ±0.5	0.05	1.12	0.12±0.03
2110-2170	20.0 ±0.5	0.05	1.15	0.12±0.03
Group Delay (GD-DC)	Directivity	Power	ΘJC	Operating Temp.
ns	dB Min	Avg. CW Watts	°C/Watt	°C
0.05±0.015	20	25	TBD	-55 to +105
0.05±0.015	23	25	TBD	-55 to +105
0.05±0.015	25	25	TBD	-55 to +105
0.05±0.015	25	25	TBD	-55 to +105
0.05±0.015	25	25	TBD	-55 to +105

\*\*Specification based on performance of unit properly installed on Anaren Test Board with small signal applied.

\*Specifications subject to change without notice. Refer to parameter definitions for details.

### Mechanical Outline

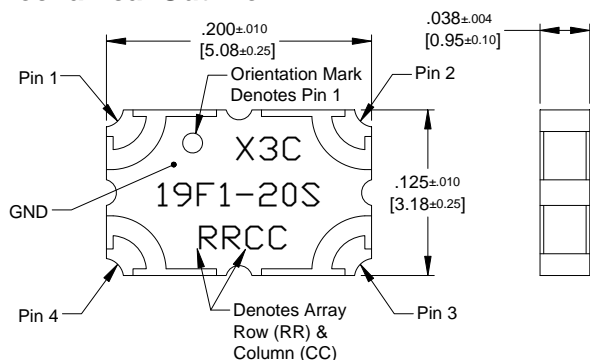

Dimensions are in Inches [Millimeters]  
X3C19F1-20S Mechanical Outline

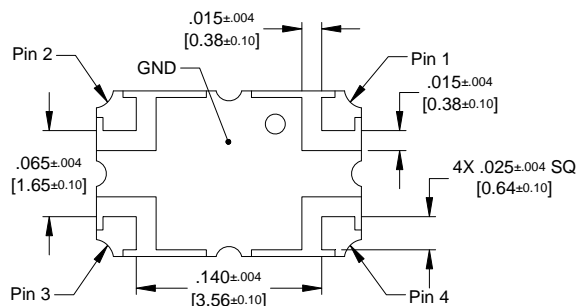

Tolerances are Non-Cumulative

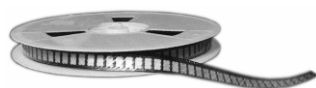

## Directional Coupler Pin Configuration

The X3C19F1-20S has an orientation marker to denote Pin 1. Once port one has been identified the other ports are known automatically. Please see the chart below for clarification:

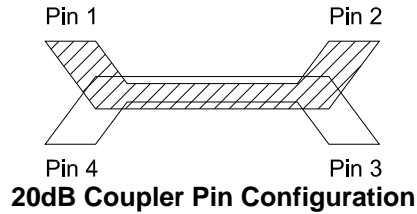

<b>Pin 1</b>	<b>Pin 2</b>	<b>Pin 3</b>	<b>Pin 4</b>
Input	Direct	Isolated	Coupled
Direct	Input	Coupled	Isolated

Note: The direct port has a DC connection to the input port and the coupled port has a DC connection to the isolated port.

For optimum IL and power handling performance, use Pin 1 or Pin 2 as inputs.

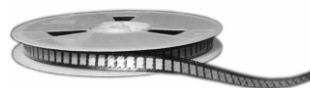

## Typical Performance (-55°C, 25°C, 85°C, 105°C): 1400-2700 MHz

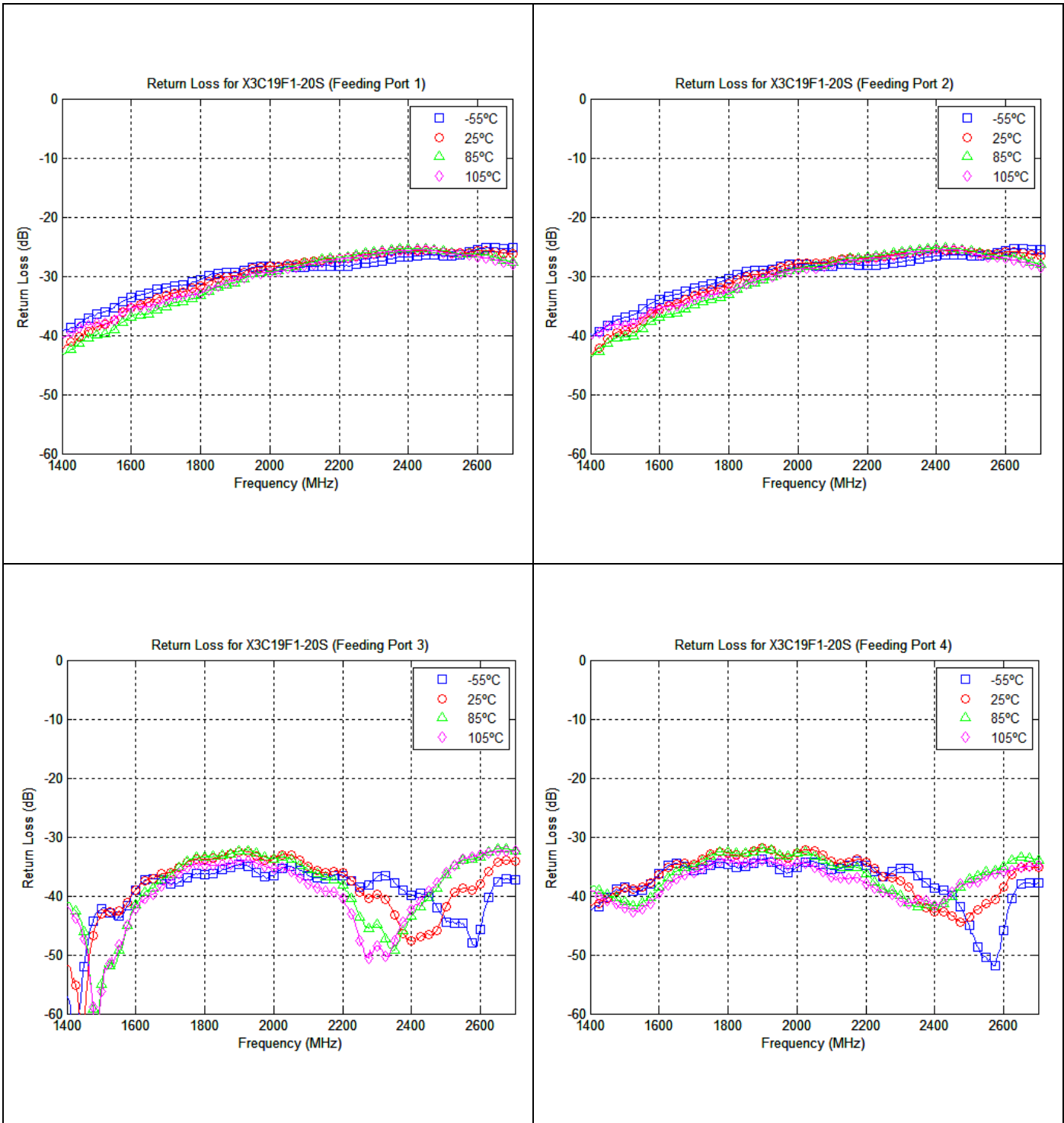

## Typical Performance (-55°C, 25°C, 85°C, 105°C): 1400-2700 MHz

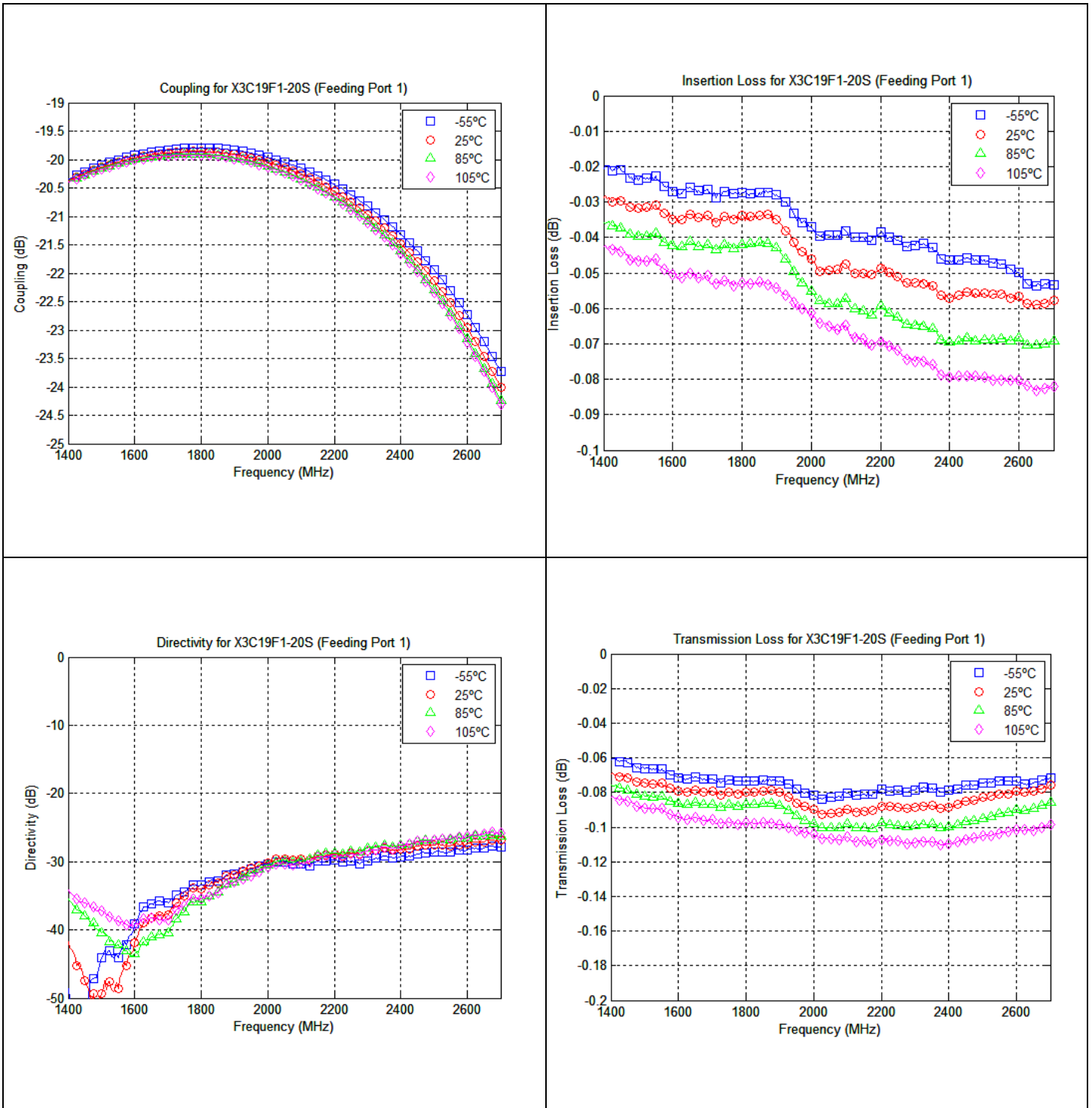

USA/Canada: (315) 432-8909  
 Toll Free: (800) 411-6596  
 Europe: +44 2392-232392

Available on Tape and Reel for Pick and Place Manufacturing.



**Anaren®**  
 What'll we think of next?®