

# TJA1051

## High-speed CAN transceiver

Rev. 9 — 28 November 2017

Product data sheet

## 1. General description

---

The TJA1051 is a high-speed CAN transceiver that provides an interface between a Controller Area Network (CAN) protocol controller and the physical two-wire CAN bus. The transceiver is designed for high-speed CAN applications in the automotive industry, providing differential transmit and receive capability to (a microcontroller with) a CAN protocol controller.

The TJA1051 belongs to the third generation of high-speed CAN transceivers from NXP Semiconductors, offering significant improvements over first- and second-generation devices such as the TJA1050. It offers improved ElectroMagnetic Compatibility (EMC) and ElectroStatic Discharge (ESD) performance, and also features:

- Ideal passive behavior to the CAN bus when the supply voltage is off
- TJA1051T/3 and TJA1051TK/3 can be interfaced directly to microcontrollers with supply voltages from 3 V to 5 V

The TJA1051 implements the CAN physical layer as defined in ISO 11898-2:2016 and SAE J2284-1 to SAE J2284-5. This implementation enables reliable communication in the CAN FD fast phase at data rates up to 5 Mbit/s.

These features make the TJA1051 an excellent choice for all types of HS-CAN networks, in nodes that do not require a standby mode with wake-up capability via the bus.

## 2. Features and benefits

---

### 2.1 General

- ISO 11898-2:2016 and SAE J2284-1 to SAE J2284-5 compliant
- Timing guaranteed for data rates up to 5 Mbit/s in the CAN FD fast phase
- Suitable for 12 V and 24 V systems
- Low ElectroMagnetic Emission (EME) and high ElectroMagnetic Immunity (EMI)
- $V_{IO}$  input on TJA1051T/3 and TJA1051TK/3 allows for direct interfacing with 3 V to 5 V microcontrollers (available in SO8 and very small HVSON8 packages respectively)
- EN input on TJA1051T/E allows the microcontroller to switch the transceiver to a very low-current Off mode
- Available in SO8 package or leadless HVSON8 package (3.0 mm × 3.0 mm) with improved Automated Optical Inspection (AOI) capability
- Dark green product (halogen free and Restriction of Hazardous Substances (RoHS) compliant)
- AEC-Q100 qualified



## 2.2 Low-power management

- Functional behavior predictable under all supply conditions
- Transceiver disengages from the bus when not powered up (zero load)

## 2.3 Protection

- High ElectroStatic Discharge (ESD) handling capability on the bus pins
- Bus pins protected against transients in automotive environments
- Transmit Data (TXD) dominant time-out function
- Undervoltage detection on pins  $V_{CC}$  and  $V_{IO}$
- Thermally protected

## 3. Quick reference data

Table 1. Quick reference data

Symbol	Parameter	Conditions	Min	Typ	Max	Unit
$V_{CC}$	supply voltage		4.5	-	5.5	V
$V_{IO}$	supply voltage on pin $V_{IO}$		2.8	-	5.5	V
$V_{uvd(VCC)}$	undervoltage detection voltage on pin $V_{CC}$		3.5	-	4.5	V
$V_{uvd(VIO)}$	undervoltage detection voltage on pin $V_{IO}$		1.3	2.0	2.7	V
$I_{CC}$	supply current	Silent mode	0.1	1	2.5	mA
		Normal mode; bus recessive	2.5	5	10	mA
		Normal mode; bus dominant	20	50	70	mA
$I_{IO}$	supply current on pin $V_{IO}$	Normal/Silent mode				
		recessive; $V_{TXD} = V_{IO}$	-	80	250	$\mu$ A
		dominant; $V_{TXD} = 0$ V	-	350	500	$\mu$ A
$V_{ESD}$	electrostatic discharge voltage	IEC 61000-4-2 at pins CANH and CANL	-8	-	+8	kV
$V_{CANH}$	voltage on pin CANH		-58	-	+58	V
$V_{CANL}$	voltage on pin CANL		-58	-	+58	V
$T_{vj}$	virtual junction temperature		-40	-	+150	$^{\circ}$ C

## 4. Ordering information

Table 2. Ordering information

Type number	Package		Version
	Name	Description	
TJA1051T	SO8	plastic small outline package; 8 leads; body width 3.9 mm	SOT96-1

Table 2. Ordering information ...continued

Type number	Package		Version
	Name	Description	
TJA1051T/3 <sup>[1]</sup>	SO8	plastic small outline package; 8 leads; body width 3.9 mm	SOT96-1
TJA1051T/E <sup>[1]</sup>	SO8	plastic small outline package; 8 leads; body width 3.9 mm	SOT96-1
TJA1051TK/3 <sup>[1]</sup>	HVSON8	plastic thermal enhanced very thin small outline package; no leads; 8 terminals; body 3 × 3 × 0.85 mm	SOT782-1

[1] TJA1051T/3 and TJA1051TK/3 with V<sub>IO</sub> pin; TJA1051T/E with EN pin.

### 5. Block diagram

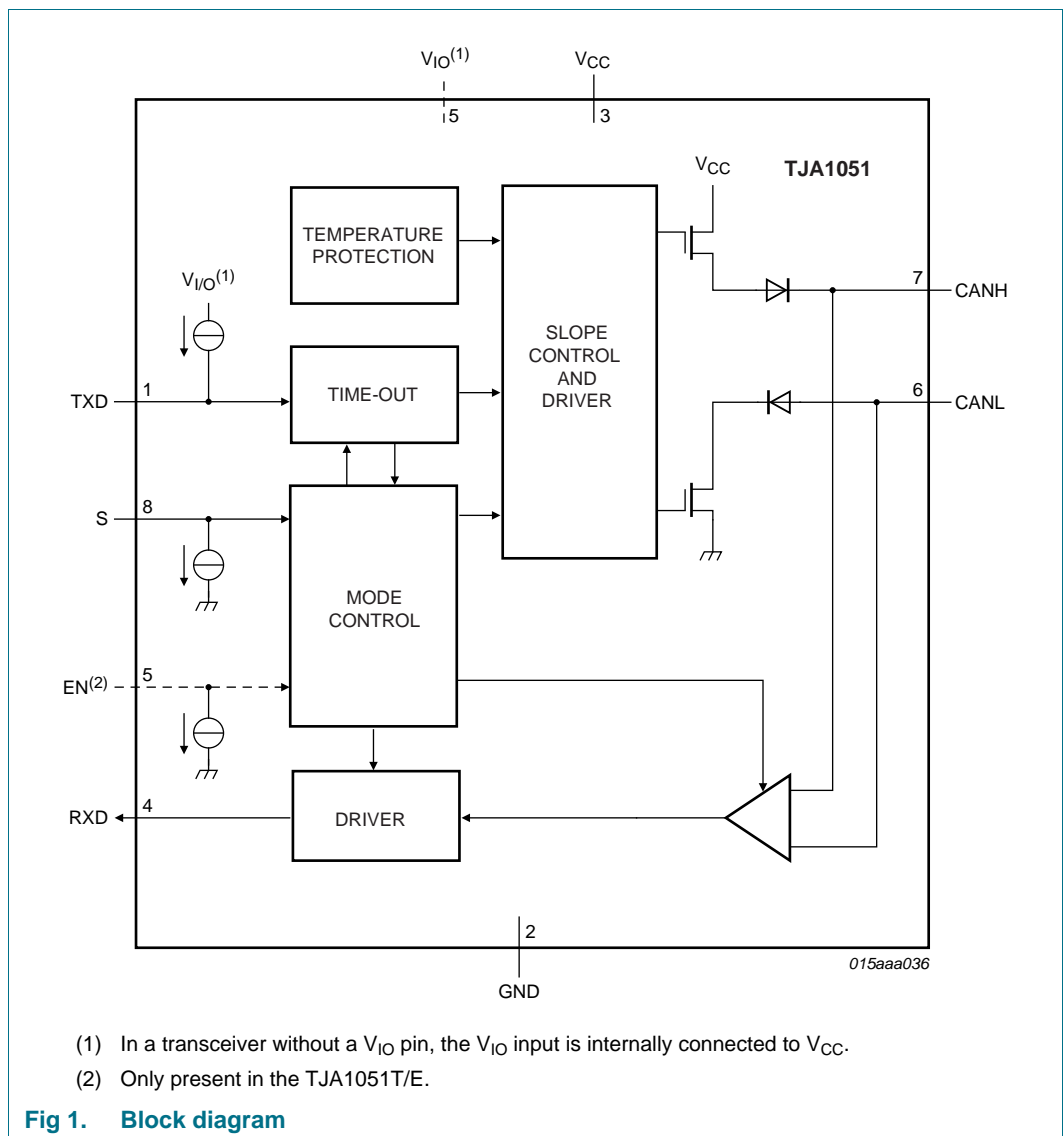

## 6. Pinning information

### 6.1 Pinning



### 6.2 Pin description

Table 3. Pin description

Symbol	Pin	Description
TXD	1	transmit data input
GND <sup>[1]</sup>	2	ground
V <sub>CC</sub>	3	supply voltage
RXD	4	receive data output; reads out data from the bus lines
n.c.	5	not connected; in TJA1051T version
EN	5	enable control input; TJA1051T/E only
V <sub>IO</sub>	5	supply voltage for I/O level adapter; TJA1051T/3 and TJA1051TK/3 only
CANL	6	LOW-level CAN bus line
CANH	7	HIGH-level CAN bus line
S	8	Silent mode control input

[1] HVSON8 package die supply ground is connected to both the GND pin and the exposed center pad. The GND pin must be soldered to board ground. For enhanced thermal and electrical performance, it is recommended that the exposed center pad also be soldered to board ground.

## 7. Functional description

The TJA1051 is a high-speed CAN stand-alone transceiver with Silent mode. It combines the functionality of the TJA1050 transceiver with improved EMC and ESD handling capability. Improved slope control and high DC handling capability on the bus pins provides additional application flexibility.

The TJA1051 is available in three versions, distinguished only by the function of pin 5:

- The TJA1051T is backwards compatible with the TJA1050
- The TJA1051T/3 and TJA1051TK/3 allow for direct interfacing to microcontrollers with supply voltages down to 3 V
- The TJA1051T/E allows the transceiver to be switched to a very low-current Off mode.

### 7.1 Operating modes

The TJA1051 supports two operating modes, Normal and Silent, which are selected via pin S. An additional Off mode is supported in the TJA1051T/E via pin EN. See [Table 4](#) for a description of the operating modes under normal supply conditions.

**Table 4. Operating modes**

Mode	Inputs			Outputs	
	Pin EN <sup>[1]</sup>	Pin S	Pin TXD	CAN driver	Pin RXD
Normal	HIGH	LOW	LOW	dominant	active <sup>[2]</sup>
	HIGH	LOW	HIGH	recessive	active <sup>[2]</sup>
Silent	HIGH	HIGH	X <sup>[3]</sup>	recessive	active <sup>[2]</sup>
Off <sup>[1]</sup>	LOW	X <sup>[3]</sup>	X <sup>[3]</sup>	floating	floating

[1] Only available on the TJA1051T/E.

[2] LOW if the CAN bus is dominant, HIGH if the CAN bus is recessive.

[3] 'X' = don't care.

#### 7.1.1 Normal mode

A LOW level on pin S selects Normal mode. In this mode, the transceiver is able to transmit and receive data via the bus lines CANH and CANL (see [Figure 1](#) for the block diagram). The differential receiver converts the analog data on the bus lines into digital data which is output to pin RXD. The slopes of the output signals on the bus lines are controlled internally and are optimized in a way that guarantees the lowest possible ElectroMagnetic Emission (EME).

#### 7.1.2 Silent mode

A HIGH level on pin S selects Silent mode. In Silent mode the transmitter is disabled, releasing the bus pins to recessive state. All other IC functions, including the receiver, continue to operate as in Normal mode. Silent mode can be used to prevent a faulty CAN controller from disrupting all network communications.

### 7.1.3 Off mode

A LOW level on pin EN of TJA1051T/E selects Off mode. In Off mode the entire transceiver is disabled, allowing the microcontroller to save power when CAN communication is not required. The bus pins are floating in Off mode, making the transceiver invisible to the rest of the network.

## 7.2 Fail-safe features

### 7.2.1 TXD dominant time-out function

A 'TXD dominant time-out' timer is started when pin TXD is set LOW. If the LOW state on pin TXD persists for longer than  $t_{to(dom)TXD}$ , the transmitter is disabled, releasing the bus lines to recessive state. This function prevents a hardware and/or software application failure from driving the bus lines to a permanent dominant state (blocking all network communications). The TXD dominant time-out timer is reset when pin TXD is set HIGH. The TXD dominant time-out time also defines the minimum possible bit rate of 20 kbit/s.

### 7.2.2 Internal biasing of TXD, S and EN input pins

Pin TXD has an internal pull-up to  $V_{IO}$  and pins S and EN (TJA1051T/E) have internal pull-downs to GND. This ensures a safe, defined state in case one or more of these pins is left floating.

### 7.2.3 Undervoltage detection on pins $V_{CC}$ and $V_{IO}$

Should  $V_{CC}$  or  $V_{IO}$  drop below their respective undervoltage detection levels ( $V_{uvd(VCC)}$  and  $V_{uvd(VIO)}$ ; see [Table 7](#)), the transceiver will switch off and disengage from the bus (zero load) until  $V_{CC}$  and  $V_{IO}$  have recovered.

### 7.2.4 Overtemperature protection

The output drivers are protected against overtemperature conditions. If the virtual junction temperature exceeds the shutdown junction temperature,  $T_{j(sd)}$ , the output drivers will be disabled until the virtual junction temperature falls below  $T_{j(sd)}$  and TXD becomes recessive again. Including the TXD condition ensures that output driver oscillations due to temperature drift are avoided.

## 7.3 $V_{IO}$ supply pin

There are three versions of the TJA1051 available, only differing in the function of a single pin. Pin 5 is either an enable control input (EN), a  $V_{IO}$  supply pin or is not connected.

Pin  $V_{IO}$  on the TJA1051T/3 and TJA1051TK/3 should be connected to the microcontroller supply voltage (see [Figure 6](#)). This will adjust the signal levels of pins TXD, RXD and S to the I/O levels of the microcontroller. For versions of the TJA1051 without a  $V_{IO}$  pin, the  $V_{IO}$  input is internally connected to  $V_{CC}$ . This sets the signal levels of pins TXD, RXD and S to levels compatible with 5 V microcontrollers.

## 8. Limiting values

**Table 5. Limiting values**

In accordance with the Absolute Maximum Rating System (IEC 60134). All voltages are referenced to GND.

Symbol	Parameter	Conditions	Min	Max	Unit
V <sub>x</sub>	voltage on pin x <sup>[1]</sup>	on pins CANH, CANL	-58	+58	V
		on any other pin	-0.3	+7	V
V <sub>(CANH-CANL)</sub>	voltage between pin CANH and pin CANL		-27	+27	V
V <sub>trt</sub>	transient voltage	on pins CANH, CANL <sup>[2]</sup>			
		pulse 1	-100	-	V
		pulse 2a	-	75	V
		pulse 3a	-150	-	V
		pulse 3b	-	100	V
V <sub>ESD</sub>	electrostatic discharge voltage	IEC 61000-4-2 (150 pF, 330 Ω) <sup>[3]</sup>			
		at pins CANH and CANL	-8	+8	kV
		Human Body Model (HBM); 100 pF, 1.5 kΩ <sup>[4]</sup>			
		at pins CANH and CANL	-8	+8	kV
		at any other pin	-4	+4	kV
		Machine Model (MM); 200 pF, 0.75 μH, 10 Ω <sup>[5]</sup>			
		at any pin	-300	+300	V
		Charged Device Model (CDM); field Induced charge; 4 pF <sup>[6]</sup>			
at corner pins	-750	+750	V		
at any pin	-500	+500	V		
T <sub>vj</sub>	virtual junction temperature	<sup>[7]</sup>	-40	+150	°C
T <sub>stg</sub>	storage temperature		-55	+150	°C

- [1] The device can sustain voltages up to the specified values over the product lifetime, provided applied voltages (including transients) never exceed these values.
- [2] According to IEC TS 62228 (2007), Section 4.2.4; parameters for standard pulses defined in ISO7637 part 2: 2004-06.
- [3] According to IEC TS 62228 (2007), Section 4.3; DIN EN 61000-4-2.
- [4] According to AEC-Q100-002.
- [5] According to AEC-Q100-003.
- [6] AEC-Q100-011 Rev-C1. The classification level is C4B.
- [7] In accordance with IEC 60747-1. An alternative definition of virtual junction temperature is:  $T_{vj} = T_{amb} + P \times R_{th(vj-a)}$ , where  $R_{th(vj-a)}$  is a fixed value to be used for the calculation of  $T_{vj}$ . The rating for  $T_{vj}$  limits the allowable combinations of power dissipation (P) and ambient temperature ( $T_{amb}$ ).

## 9. Thermal characteristics

**Table 6. Thermal characteristics**

According to IEC 60747-1.

Symbol	Parameter	Conditions	Value	Unit
R <sub>th(vj-a)</sub>	thermal resistance from virtual junction to ambient	SO8 package; in free air	155	K/W
		HVSON8 package; in free air	55	K/W

## 10. Static characteristics

**Table 7. Static characteristics**

$T_{vj} = -40\text{ }^{\circ}\text{C}$  to  $+150\text{ }^{\circ}\text{C}$ ;  $V_{CC} = 4.5\text{ V}$  to  $5.5\text{ V}$ ;  $V_{IO} = 2.8\text{ V}$  to  $5.5\text{ V}$ <sup>[1]</sup>;  $R_L = 60\ \Omega$  unless specified otherwise; All voltages are defined with respect to ground; Positive currents flow into the IC<sup>[2]</sup>.

Symbol	Parameter	Conditions	Min	Typ	Max	Unit
<b>Supply; pin V<sub>CC</sub></b>						
V <sub>CC</sub>	supply voltage		4.5	-	5.5	V
I <sub>CC</sub>	supply current	Off mode (TJA1051T/E)	1	5	8	μA
		Silent mode	0.1	1	2.5	mA
		Normal mode				
		recessive; V <sub>TXD</sub> = V <sub>IO</sub> <sup>[3]</sup>	-	5	10	mA
		dominant; V <sub>TXD</sub> = 0 V	-	50	70	mA
		dominant; V <sub>TXD</sub> = 0 V; short circuit on bus lines; -3 V < (V <sub>CANH</sub> = V <sub>CANL</sub> ) < +18 V	2.5	80	110	mA
V <sub>uvd(VCC)</sub>	undervoltage detection voltage on pin V <sub>CC</sub>		3.5	-	4.5	V
<b>I/O level adapter supply; pin V<sub>IO</sub><sup>[1]</sup></b>						
V <sub>IO</sub>	supply voltage on pin V <sub>IO</sub>		2.8	-	5.5	V
I <sub>IO</sub>	supply current on pin V <sub>IO</sub>	Normal/Silent mode				
		recessive; V <sub>TXD</sub> = V <sub>IO</sub> <sup>[3]</sup>	-	80	250	μA
		dominant; V <sub>TXD</sub> = 0 V	-	350	500	μA
V <sub>uvd(VIO)</sub>	undervoltage detection voltage on pin V <sub>IO</sub>		1.3	2.0	2.7	V
<b>Mode control inputs; pins S and EN<sup>[4]</sup></b>						
V <sub>IH</sub>	HIGH-level input voltage		<sup>[5]</sup> 0.7V <sub>IO</sub> <sup>[3]</sup>	-	V <sub>IO</sub> + 0.3 <sup>[3]</sup>	V
V <sub>IL</sub>	LOW-level input voltage		-0.3	-	0.3V <sub>IO</sub> <sup>[3]</sup>	V
I <sub>IH</sub>	HIGH-level input current	V <sub>S</sub> = V <sub>IO</sub> ; V <sub>EN</sub> = V <sub>IO</sub> <sup>[3]</sup>	1	4	10	μA
I <sub>IL</sub>	LOW-level input current	V <sub>S</sub> = 0 V; V <sub>EN</sub> = 0 V	-1	0	+1	μA
<b>CAN transmit data input; pin TXD</b>						
V <sub>IH</sub>	HIGH-level input voltage		<sup>[5]</sup> 0.7V <sub>IO</sub> <sup>[3]</sup>	-	V <sub>IO</sub> + 0.3 <sup>[3]</sup>	V
V <sub>IL</sub>	LOW-level input voltage		-0.3	-	+0.3V <sub>IO</sub> <sup>[3]</sup>	V
I <sub>IH</sub>	HIGH-level input current	V <sub>TXD</sub> = V <sub>IO</sub> <sup>[3]</sup>	-5	0	+5	μA
I <sub>IL</sub>	LOW-level input current	Normal mode; V <sub>TXD</sub> = 0 V	-260	-150	-30	μA
C <sub>i</sub>	input capacitance		<sup>[6]</sup> -	5	10	pF
<b>CAN receive data output; pin RXD</b>						
I <sub>OH</sub>	HIGH-level output current	V <sub>RXD</sub> = V <sub>IO</sub> - 0.4 V <sup>[3]</sup>	-8	-3	-1	mA
I <sub>OL</sub>	LOW-level output current	V <sub>RXD</sub> = 0.4 V; bus dominant	2	5	12	mA
<b>Bus lines; pins CANH and CANL</b>						
V <sub>O(dom)</sub>	dominant output voltage	V <sub>TXD</sub> = 0 V; t < t <sub>to(dom)TXD</sub>				
		pin CANH; R <sub>L</sub> = 50 Ω to 65 Ω	2.75	3.5	4.5	V
		pin CANL; R <sub>L</sub> = 50 Ω to 65 Ω	0.5	1.5	2.25	V
V <sub>dom(TX)sym</sub>	transmitter dominant voltage symmetry	V <sub>dom(TX)sym</sub> = V <sub>CC</sub> - V <sub>CANH</sub> - V <sub>CANL</sub>	-400	-	+400	mV



**Table 7. Static characteristics ...continued**

$T_{Vj} = -40\text{ }^{\circ}\text{C}$  to  $+150\text{ }^{\circ}\text{C}$ ;  $V_{CC} = 4.5\text{ V}$  to  $5.5\text{ V}$ ;  $V_{IO} = 2.8\text{ V}$  to  $5.5\text{ V}$ <sup>[1]</sup>;  $R_L = 60\text{ }\Omega$  unless specified otherwise; All voltages are defined with respect to ground; Positive currents flow into the IC<sup>[2]</sup>.

Symbol	Parameter	Conditions	Min	Typ	Max	Unit
$V_{TXsym}$	transmitter voltage symmetry	$V_{TXsym} = V_{CANH} + V_{CANL}$ ; <sup>[6]</sup> $f_{TXD} = 250\text{ kHz}, 1\text{ MHz}$ and $2.5\text{ MHz}$ ; <sup>[7]</sup> $V_{CC} = 4.75\text{ V}$ to $5.25\text{ V}$ ; $C_{SPLIT} = 4.7\text{ nF}$	$0.9V_{CC}$	-	$1.1V_{CC}$	V
$V_{O(dif)}$	differential output voltage	dominant: Normal mode; $V_{TXD} = 0\text{ V}$ ; $t < t_{to(dom)TXD}$ ; $V_{CC} = 4.75\text{ V}$ to $5.25\text{ V}$				
		$R_L = 45\text{ }\Omega$ to $65\text{ }\Omega$	1.5	-	3	V
		$R_L = 45\text{ }\Omega$ to $70\text{ }\Omega$	1.5	-	3.3	V
		$R_L = 2240\text{ }\Omega$	1.5	-	5	V
		recessive; no load				
	Normal mode: $V_{TXD} = V_{IO}$ <sup>[3]</sup>	-50	-	+50	mV	
$V_{O(rec)}$	recessive output voltage	Normal/Silent mode; $V_{TXD} = V_{IO}$ <sup>[3]</sup> ; no load	2	$0.5V_{CC}$	3	V
$V_{th(RX)dif}$	differential receiver threshold voltage	Normal/Silent mode; $-30\text{ V} \leq V_{CANL} \leq +30\text{ V}$ ; $-30\text{ V} \leq V_{CANH} \leq +30\text{ V}$	0.5	0.7	0.9	V
$V_{rec(RX)}$	receiver recessive voltage	Normal/Silent mode; $-30\text{ V} \leq V_{CANL} \leq +30\text{ V}$ ; $-30\text{ V} \leq V_{CANH} \leq +30\text{ V}$	-4	-	0.5	V
$V_{dom(RX)}$	receiver dominant voltage	Normal/Silent mode; $-30\text{ V} \leq V_{CANL} \leq +30\text{ V}$ ; $-30\text{ V} \leq V_{CANH} \leq +30\text{ V}$	0.9	-	9.0	V
$V_{hys(RX)dif}$	differential receiver hysteresis voltage	Normal/Silent mode; $-30\text{ V} \leq V_{CANL} \leq +30\text{ V}$ ; $-30\text{ V} \leq V_{CANH} \leq +30\text{ V}$	50	120	200	mV
$I_{O(sc)dom}$	dominant short-circuit output current	$V_{TXD} = 0\text{ V}$ ; $t < t_{to(dom)TXD}$ ; $V_{CC} = 5\text{ V}$				
		pin CANH; $V_{CANH} = -15\text{ V}$ to $+40\text{ V}$	-100	-70	-40	mA
		pin CANL; $V_{CANL} = -15\text{ V}$ to $+40\text{ V}$	40	70	100	mA
$I_{O(sc)rec}$	recessive short-circuit output current	Normal/Silent mode; $V_{TXD} = V_{IO}$ <sup>[3]</sup> ; $V_{CANH} = V_{CANL} = -27\text{ V}$ to $+32\text{ V}$	-5	-	+5	mA
$I_L$	leakage current	$V_{CC} = V_{IO} = 0\text{ V}$ or $V_{CC} = V_{IO} =$ shorted to ground via $47\text{ k}\Omega$ ; $V_{CANH} = V_{CANL} = 5\text{ V}$	-5	0	+5	$\mu\text{A}$
$R_i$	input resistance	$-2\text{ V} \leq V_{CANL} \leq +7\text{ V}$ ; <sup>[6]</sup> $-2\text{ V} \leq V_{CANH} \leq +7\text{ V}$	9	15	28	$\text{k}\Omega$
$\Delta R_i$	input resistance deviation	$0\text{ V} \leq V_{CANL} \leq +5\text{ V}$ ; <sup>[6]</sup> $0\text{ V} \leq V_{CANH} \leq +5\text{ V}$	-1	-	+1	%
$R_{i(dif)}$	differential input resistance	$-2\text{ V} \leq V_{CANL} \leq +7\text{ V}$ ; <sup>[6]</sup> $-2\text{ V} \leq V_{CANH} \leq +7\text{ V}$	19	30	52	$\text{k}\Omega$
$C_{i(cm)}$	common-mode input capacitance				20	pF

**Table 7. Static characteristics ...continued**

$T_{vj} = -40\text{ }^{\circ}\text{C}$  to  $+150\text{ }^{\circ}\text{C}$ ;  $V_{CC} = 4.5\text{ V}$  to  $5.5\text{ V}$ ;  $V_{IO} = 2.8\text{ V}$  to  $5.5\text{ V}$ <sup>[1]</sup>;  $R_L = 60\ \Omega$  unless specified otherwise; All voltages are defined with respect to ground; Positive currents flow into the IC<sup>[2]</sup>.

Symbol	Parameter	Conditions	Min	Typ	Max	Unit
$C_{i(dif)}$	differential input capacitance	[6]	-	-	10	pF
<b>Temperature protection</b>						
$T_{j(sd)}$	shutdown junction temperature	[6]	-	190	-	$^{\circ}\text{C}$

- [1] Only TJA1051T/3 and TJA1051TK/3 have a  $V_{IO}$  pin. In transceivers without a  $V_{IO}$  pin, the  $V_{IO}$  input is internally connected to  $V_{CC}$ .
- [2] All parameters are guaranteed over the virtual junction temperature range by design. Factory testing uses correlated test conditions to cover the specified temperature and power supply voltage range.
- [3]  $V_{IO} = V_{CC}$  for the non- $V_{IO}$  product variants TJA1051T(E)
- [4] Only TJA1051T/E has an EN pin.
- [5] Maximum value assumes  $V_{CC} < V_{IO}$ ; if  $V_{CC} > V_{IO}$ , the maximum value will be  $V_{CC} + 0.3\text{ V}$ .
- [6] Not tested in production; guaranteed by design.
- [7] The test circuit used to measure the bus output voltage symmetry (which includes  $C_{SPLIT}$ ) is shown in [Figure 8](#).

## 11. Dynamic characteristics

**Table 8. Dynamic characteristics**

$T_{vj} = -40\text{ }^{\circ}\text{C}$  to  $+150\text{ }^{\circ}\text{C}$ ;  $V_{CC} = 4.5\text{ V}$  to  $5.5\text{ V}$ ;  $V_{IO} = 2.8\text{ V}$  to  $5.5\text{ V}$ <sup>[1]</sup>;  $R_L = 60\ \Omega$  unless specified otherwise. All voltages are defined with respect to ground. Positive currents flow into the IC<sup>[2]</sup>

Symbol	Parameter	Conditions	Min	Typ	Max	Unit
<b>Transceiver timing; pins CANH, CANL, TXD and RXD; see <a href="#">Figure 7</a> and <a href="#">Figure 3</a></b>						
$t_{d(TXD-busdom)}$	delay time from TXD to bus dominant	Normal mode	-	65	-	ns
$t_{d(TXD-busrec)}$	delay time from TXD to bus recessive	Normal mode	-	90	-	ns
$t_{d(busdom-RXD)}$	delay time from bus dominant to RXD	Normal/Silent mode	-	60	-	ns
$t_{d(busrec-RXD)}$	delay time from bus recessive to RXD	Normal/Silent mode	-	65	-	ns
$t_{d(TXDL-RXDL)}$	delay time from TXD LOW to RXD LOW	Normal mode: versions with $V_{IO}$ pin	40	-	250	ns
		Normal mode: other versions	40	-	220	ns
$t_{d(TXDH-RXDH)}$	delay time from TXD HIGH to RXD HIGH	Normal mode: versions with $V_{IO}$ pin	40	-	250	ns
		Normal mode: other versions	40	-	220	ns
$t_{bit(bus)}$	transmitted recessive bit width	$t_{bit(TXD)} = 500\text{ ns}$	[3] 435	-	530	ns
		$t_{bit(TXD)} = 200\text{ ns}$	[3] 155	-	210	ns
$t_{bit(RXD)}$	bit time on pin RXD	$t_{bit(TXD)} = 500\text{ ns}$	[3] 400	-	550	ns
		$t_{bit(TXD)} = 200\text{ ns}$	[3] 120	-	220	ns
$\Delta t_{rec}$	receiver timing symmetry	$t_{bit(TXD)} = 500\text{ ns}$	-65	-	+40	ns
		$t_{bit(TXD)} = 200\text{ ns}$	-45	-	+15	ns
$t_{to(dom)TXD}$	TXD dominant time-out time	$V_{TXD} = 0\text{ V}$ ; Normal mode [4]	0.3	1	5	ms

- [1] Only TJA1051T/3 and TJA1051TK/3 have a  $V_{IO}$  pin. In transceivers without a  $V_{IO}$  pin, the  $V_{IO}$  input is internally connected to  $V_{CC}$ .
- [2] All parameters are guaranteed over the virtual junction temperature range by design. Factory testing uses correlated test conditions to cover the specified temperature and power supply voltage range.

- [3] See [Figure 4](#).
- [4] Minimum value of 0.8ms required according to SAE J2284; 0.3ms is allowed according to ISO11898-2:2016 for legacy devices.

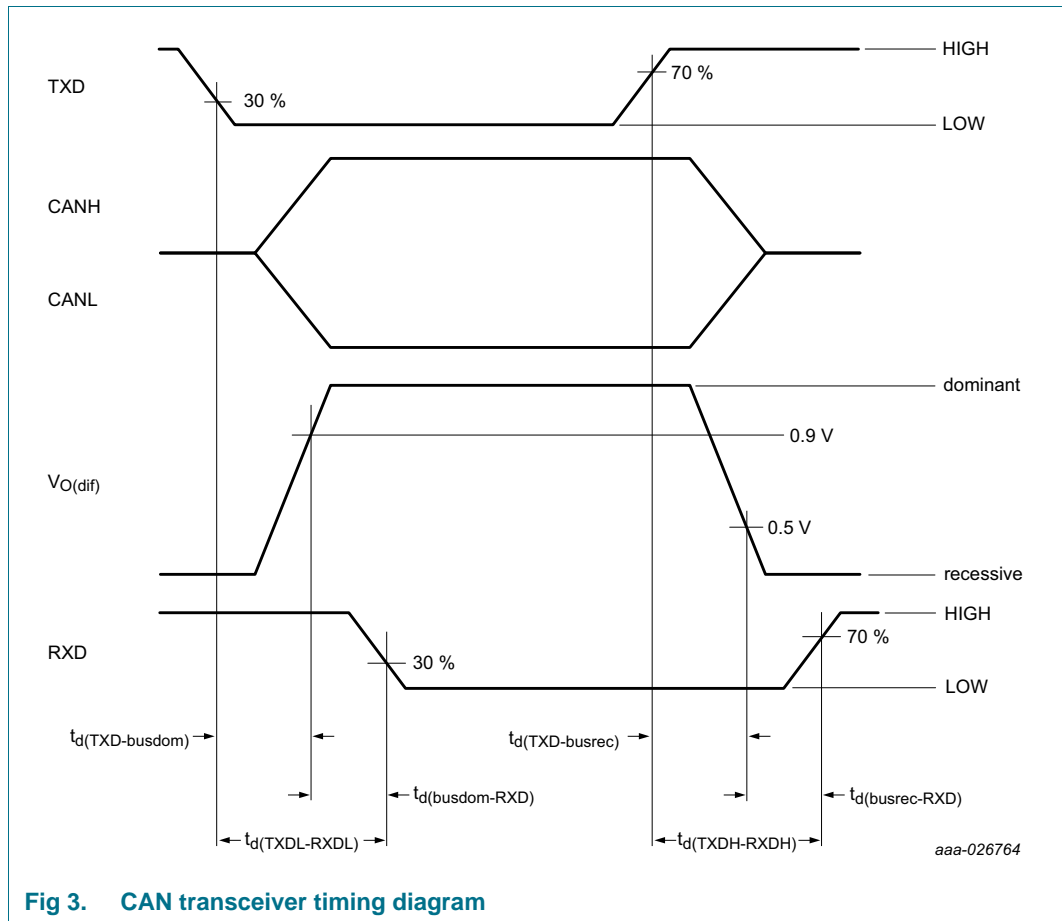

Fig 3. CAN transceiver timing diagram

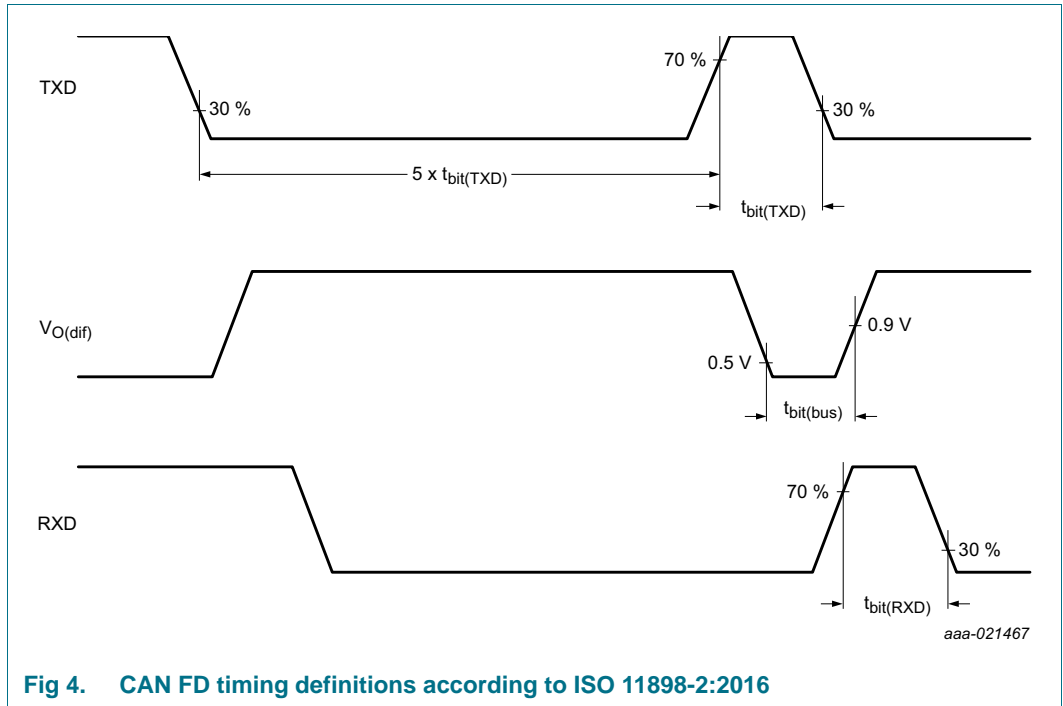

Fig 4. CAN FD timing definitions according to ISO 11898-2:2016

## 12. Application information

### 12.1 Application diagrams

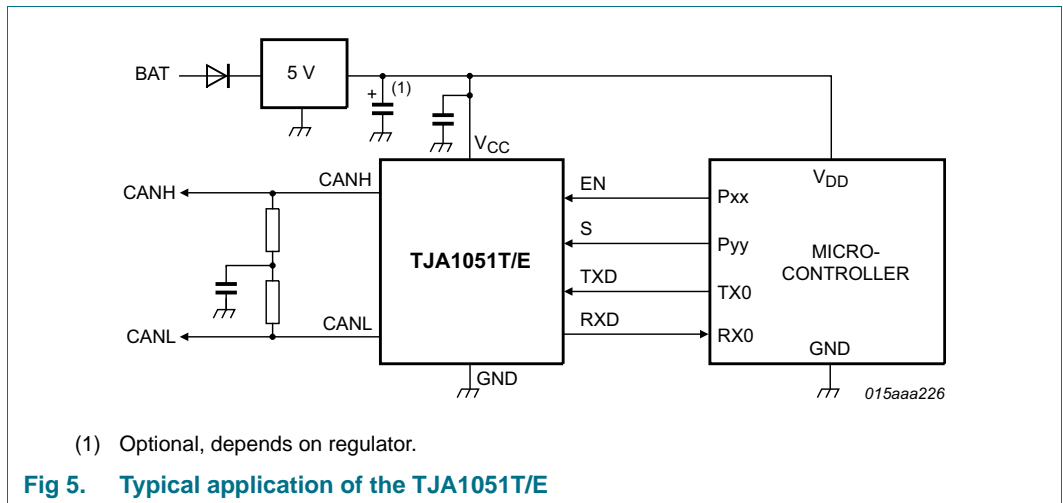

Fig 5. Typical application of the TJA1051T/E



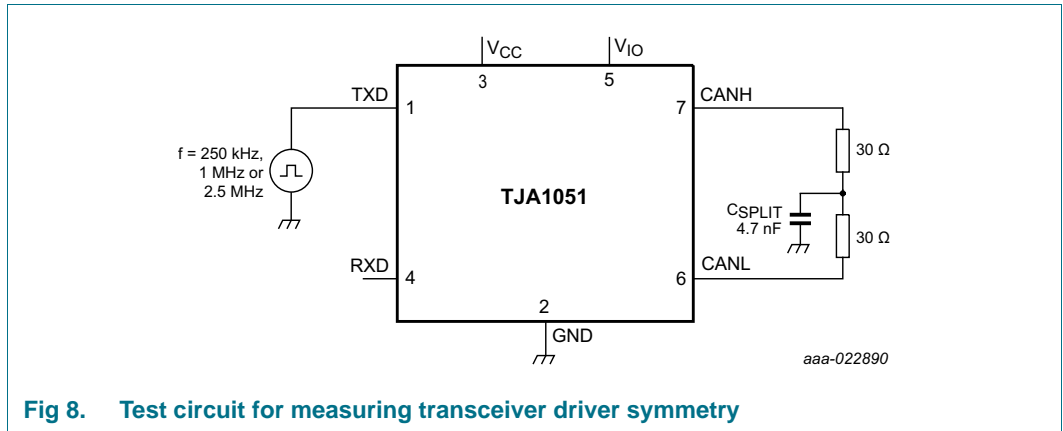

Fig 8. Test circuit for measuring transceiver driver symmetry

### 13.1 Quality information

This product has been qualified in accordance with the Automotive Electronics Council (AEC) standard Q100 Rev-G - *Failure mechanism based stress test qualification for integrated circuits*, and is suitable for use in automotive applications.

### 14. Package outline

SO8: plastic small outline package; 8 leads; body width 3.9 mm

SOT96-1

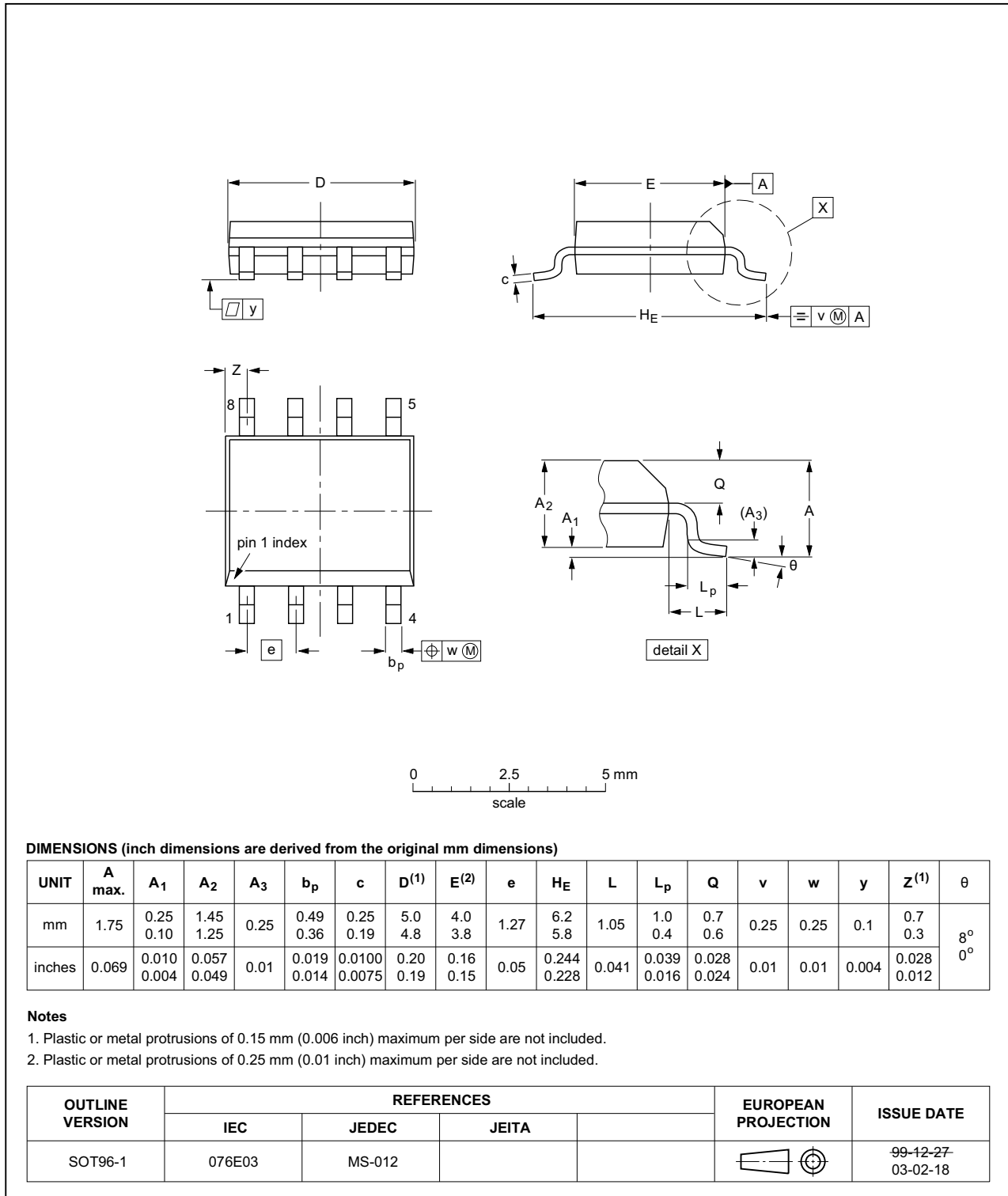
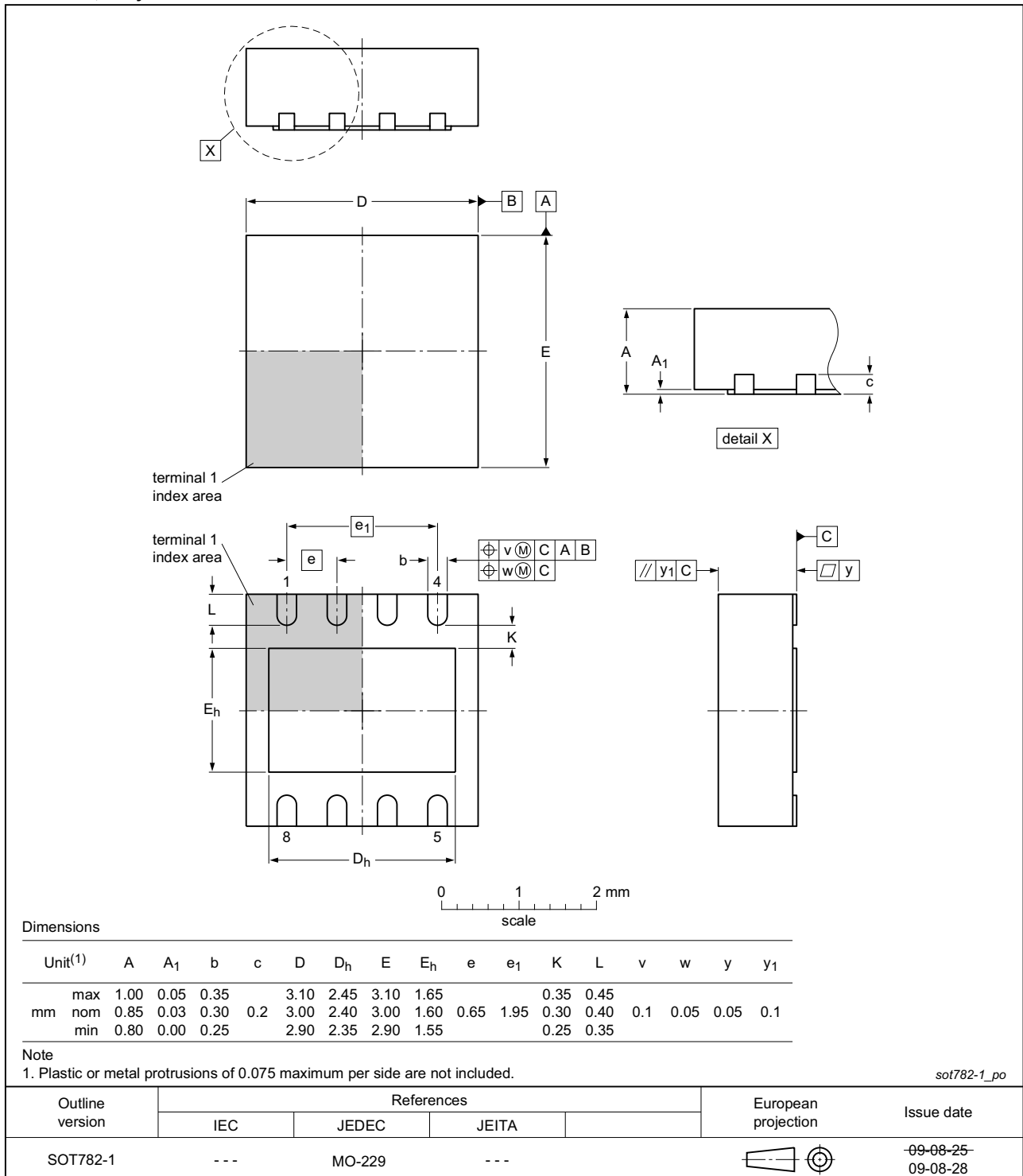

Fig 9. Package outline SOT96-1 (SO8)

**HVSON8: plastic thermal enhanced very thin small outline package; no leads;  
8 terminals; body 3 x 3 x 0.85 mm**

**SOT782-1**



**Fig 10. Package outline SOT782-1 (HVSON8)**



## 15. Handling information

All input and output pins are protected against ElectroStatic Discharge (ESD) under normal handling. When handling ensure that the appropriate precautions are taken as described in *JESD625-A* or equivalent standards.

## 16. Soldering of SMD packages

This text provides a very brief insight into a complex technology. A more in-depth account of soldering ICs can be found in Application Note *AN10365 "Surface mount reflow soldering description"*.

### 16.1 Introduction to soldering

Soldering is one of the most common methods through which packages are attached to Printed Circuit Boards (PCBs), to form electrical circuits. The soldered joint provides both the mechanical and the electrical connection. There is no single soldering method that is ideal for all IC packages. Wave soldering is often preferred when through-hole and Surface Mount Devices (SMDs) are mixed on one printed wiring board; however, it is not suitable for fine pitch SMDs. Reflow soldering is ideal for the small pitches and high densities that come with increased miniaturization.

### 16.2 Wave and reflow soldering

Wave soldering is a joining technology in which the joints are made by solder coming from a standing wave of liquid solder. The wave soldering process is suitable for the following:

- Through-hole components
- Leaded or leadless SMDs, which are glued to the surface of the printed circuit board

Not all SMDs can be wave soldered. Packages with solder balls, and some leadless packages which have solder lands underneath the body, cannot be wave soldered. Also, leaded SMDs with leads having a pitch smaller than ~0.6 mm cannot be wave soldered, due to an increased probability of bridging.

The reflow soldering process involves applying solder paste to a board, followed by component placement and exposure to a temperature profile. Leaded packages, packages with solder balls, and leadless packages are all reflow solderable.

Key characteristics in both wave and reflow soldering are:

- Board specifications, including the board finish, solder masks and vias
- Package footprints, including solder thieves and orientation
- The moisture sensitivity level of the packages
- Package placement
- Inspection and repair
- Lead-free soldering versus SnPb soldering

### 16.3 Wave soldering

Key characteristics in wave soldering are:

- Process issues, such as application of adhesive and flux, clinching of leads, board transport, the solder wave parameters, and the time during which components are exposed to the wave
- Solder bath specifications, including temperature and impurities

### 16.4 Reflow soldering

Key characteristics in reflow soldering are:

- Lead-free versus SnPb soldering; note that a lead-free reflow process usually leads to higher minimum peak temperatures (see [Figure 11](#)) than a SnPb process, thus reducing the process window
- Solder paste printing issues including smearing, release, and adjusting the process window for a mix of large and small components on one board
- Reflow temperature profile; this profile includes preheat, reflow (in which the board is heated to the peak temperature) and cooling down. It is imperative that the peak temperature is high enough for the solder to make reliable solder joints (a solder paste characteristic). In addition, the peak temperature must be low enough that the packages and/or boards are not damaged. The peak temperature of the package depends on package thickness and volume and is classified in accordance with [Table 9](#) and [10](#)

**Table 9. SnPb eutectic process (from J-STD-020D)**

Package thickness (mm)	Package reflow temperature (°C)	
	Volume (mm <sup>3</sup> )	
	< 350	≥ 350
< 2.5	235	220
≥ 2.5	220	220

**Table 10. Lead-free process (from J-STD-020D)**

Package thickness (mm)	Package reflow temperature (°C)		
	Volume (mm <sup>3</sup> )		
	< 350	350 to 2000	> 2000
< 1.6	260	260	260
1.6 to 2.5	260	250	245
> 2.5	250	245	245

Moisture sensitivity precautions, as indicated on the packing, must be respected at all times.

Studies have shown that small packages reach higher temperatures during reflow soldering, see [Figure 11](#).



For further information on temperature profiles, refer to Application Note *AN10365* “*Surface mount reflow soldering description*”.

## 17. Soldering of HVSON packages

[Section 17](#) contains a brief introduction to the techniques most commonly used to solder Surface Mounted Devices (SMD). A more detailed discussion on soldering HVSON leadless package ICs can be found in the following application notes:

- *AN10365* “*Surface mount reflow soldering description*”
- *AN10366* “*HVQFN application information*”

## 18. Appendix: ISO 11898-2:2016 parameter cross-reference list

Table 11. ISO 11898-2:2016 to NXP data sheet parameter conversion

ISO 11898-2:2016		NXP data sheet	
Parameter	Notation	Symbol	Parameter
<b>HS-PMA dominant output characteristics</b>			
Single ended voltage on CAN_H	$V_{CAN\_H}$	$V_{O(dom)}$	dominant output voltage
Single ended voltage on CAN_L	$V_{CAN\_L}$		
Differential voltage on normal bus load	$V_{Diff}$	$V_{O(dif)}$	differential output voltage
Differential voltage on effective resistance during arbitration			
Optional: Differential voltage on extended bus load range			
<b>HS-PMA driver symmetry</b>			
Driver symmetry	$V_{SYM}$	$V_{TXsym}$	transmitter voltage symmetry
<b>Maximum HS-PMA driver output current</b>			
Absolute current on CAN_H	$I_{CAN\_H}$	$I_{O(sc)dom}$	dominant short-circuit output current
Absolute current on CAN_L	$I_{CAN\_L}$		
<b>HS-PMA recessive output characteristics, bus biasing active/inactive</b>			
Single ended output voltage on CAN_H	$V_{CAN\_H}$	$V_{O(rec)}$	recessive output voltage
Single ended output voltage on CAN_L	$V_{CAN\_L}$		
Differential output voltage	$V_{Diff}$	$V_{O(dif)}$	differential output voltage
<b>Optional HS-PMA transmit dominant timeout</b>			
Transmit dominant timeout, long	$t_{dom}$	$t_{to(dom)TXD}$	TXD dominant time-out time
Transmit dominant timeout, short			
<b>HS-PMA static receiver input characteristics, bus biasing active/inactive</b>			
Recessive state differential input voltage range	$V_{Diff}$	$V_{th(RX)dif}$	differential receiver threshold voltage
Dominant state differential input voltage range		$V_{rec(RX)}$	receiver recessive voltage
		$V_{dom(RX)}$	receiver dominant voltage
<b>HS-PMA receiver input resistance (matching)</b>			
Differential internal resistance	$R_{Diff}$	$R_{i(dif)}$	differential input resistance
Single ended internal resistance	$R_{CAN\_H}$ $R_{CAN\_L}$	$R_i$	input resistance
Matching of internal resistance	MR	$\Delta R_i$	input resistance deviation
<b>HS-PMA implementation loop delay requirement</b>			
Loop delay	$t_{Loop}$	$t_{d(TXDH-RXDH)}$	delay time from TXD HIGH to RXD HIGH
		$t_{d(TXDL-RXDL)}$	delay time from TXD LOW to RXD LOW
<b>Optional HS-PMA implementation data signal timing requirements for use with bit rates above 1 Mbit/s up to 2 Mbit/s and above 2 Mbit/s up to 5 Mbit/s</b>			
Transmitted recessive bit width @ 2 Mbit/s / @ 5 Mbit/s, intended	$t_{Bit(Bus)}$	$t_{bit(bus)}$	transmitted recessive bit width
Received recessive bit width @ 2 Mbit/s / @ 5 Mbit/s	$t_{Bit(RXD)}$	$t_{bit(RXD)}$	bit time on pin RXD
Receiver timing symmetry @ 2 Mbit/s / @ 5 Mbit/s	$\Delta t_{Rec}$	$\Delta t_{rec}$	receiver timing symmetry

Table 11. ISO 11898-2:2016 to NXP data sheet parameter conversion ...continued

ISO 11898-2:2016		NXP data sheet	
Parameter	Notation	Symbol	Parameter
<b>HS-PMA maximum ratings of V<sub>CAN_H</sub>, V<sub>CAN_L</sub> and V<sub>Diff</sub></b>			
Maximum rating V <sub>Diff</sub>	V <sub>Diff</sub>	V <sub>(CANH-CANL)</sub>	voltage between pin CANH and pin CANL
General maximum rating V <sub>CAN_H</sub> and V <sub>CAN_L</sub>	V <sub>CAN_H</sub>	V <sub>x</sub>	voltage on pin x
Optional: Extended maximum rating V <sub>CAN_H</sub> and V <sub>CAN_L</sub>	V <sub>CAN_L</sub>		
<b>HS-PMA maximum leakage currents on CAN_H and CAN_L, unpowered</b>			
Leakage current on CAN_H, CAN_L	I <sub>CAN_H</sub> I <sub>CAN_L</sub>	I <sub>L</sub>	leakage current
<b>HS-PMA bus biasing control timings</b>			
CAN activity filter time, long	t <sub>Filter</sub>	t <sub>wake(busdom)</sub> <sup>[1]</sup>	bus dominant wake-up time
CAN activity filter time, short		t <sub>wake(busrec)</sub> <sup>[1]</sup>	bus recessive wake-up time
Wake-up timeout, short	t <sub>Wake</sub>	t <sub>to(wake)bus</sub>	bus wake-up time-out time
Wake-up timeout, long			
Timeout for bus inactivity	t <sub>Silence</sub>	t <sub>to(silence)</sub>	bus silence time-out time
Bus Bias reaction time	t <sub>Bias</sub>	t <sub>d(busact-bias)</sub>	delay time from bus active to bias

[1] t<sub>filtr(wake)bus</sub> - bus wake-up filter time, in devices with basic wake-up functionality

## 19. Revision history

Table 12. Revision history

Document ID	Release date	Data sheet status	Change notice	Supersedes
TJA1051 v.9	20171128	Product data sheet	-	TJA1051 v.8.1
Modifications:	<ul style="list-style-type: none"> <li>• Updated to comply with ISO 11898-2:2016 and SAE J22884-1 through SAE J2284-5 specifications:               <ul style="list-style-type: none"> <li>– <a href="#">Section 1</a>: text amended (2nd last paragraph)</li> <li>– <a href="#">Section 2.1</a>: text amended (1st entry)</li> <li>– <a href="#">Table 7</a>: values changed and/or measurements conditions amended/added for parameters <math>I_{CC}</math>, <math>V_{dom(TX)_{sym}}</math>, <math>V_{TX_{sym}}</math>, <math>V_{O(dif)}</math>, <math>V_{rec(RX)}</math>, <math>V_{dom(RX)}</math>, <math>I_{O(sc)_{dom}}</math>, <math>R_i</math>, <math>\Delta R_i</math> and <math>R_{i(dif)}</math></li> <li>– <a href="#">Table 8</a>: <a href="#">Table note 4</a> added</li> <li>– <a href="#">Figure 3</a>: thresholds clarified</li> <li>– <a href="#">Figure 4</a>: title changed</li> </ul> </li> <li>• <a href="#">Figure 5</a>, <a href="#">Figure 6</a>, <a href="#">Figure 8</a>: amended</li> </ul>			
TJA1051 v.8.1	20160712	Product data sheet	-	TJA1051 v.7
TJA1051 v.7	20150115	Product data sheet	-	TJA1051 v.6
TJA1051 v.6	20110325	Product data sheet	-	TJA1051 v.5
TJA1051 v.5	20101229	Product data sheet	-	TJA1051 v.4
TJA1051 v.4	20091020	Product data sheet	-	TJA1051 v.3
TJA1051 v.3	20090825	Product data sheet	-	TJA1051 v.2
TJA1051 v.2	20090701	Product data sheet	-	TJA1051 v.1
TJA1051 v.1	20090309	Product data sheet	-	-

## 20. Legal information

### 20.1 Data sheet status

Document status <sup>[1][2]</sup>	Product status <sup>[3]</sup>	Definition
Objective [short] data sheet	Development	This document contains data from the objective specification for product development.
Preliminary [short] data sheet	Qualification	This document contains data from the preliminary specification.
Product [short] data sheet	Production	This document contains the product specification.

[1] Please consult the most recently issued document before initiating or completing a design.

[2] The term 'short data sheet' is explained in section "Definitions".

[3] The product status of device(s) described in this document may have changed since this document was published and may differ in case of multiple devices. The latest product status information is available on the Internet at URL <http://www.nxp.com>.

### 20.2 Definitions

**Draft** — The document is a draft version only. The content is still under internal review and subject to formal approval, which may result in modifications or additions. NXP Semiconductors does not give any representations or warranties as to the accuracy or completeness of information included herein and shall have no liability for the consequences of use of such information.

**Short data sheet** — A short data sheet is an extract from a full data sheet with the same product type number(s) and title. A short data sheet is intended for quick reference only and should not be relied upon to contain detailed and full information. For detailed and full information see the relevant full data sheet, which is available on request via the local NXP Semiconductors sales office. In case of any inconsistency or conflict with the short data sheet, the full data sheet shall prevail.

**Product specification** — The information and data provided in a Product data sheet shall define the specification of the product as agreed between NXP Semiconductors and its customer, unless NXP Semiconductors and customer have explicitly agreed otherwise in writing. In no event however, shall an agreement be valid in which the NXP Semiconductors product is deemed to offer functions and qualities beyond those described in the Product data sheet.

### 20.3 Disclaimers

**Limited warranty and liability** — Information in this document is believed to be accurate and reliable. However, NXP Semiconductors does not give any representations or warranties, expressed or implied, as to the accuracy or completeness of such information and shall have no liability for the consequences of use of such information. NXP Semiconductors takes no responsibility for the content in this document if provided by an information source outside of NXP Semiconductors.

In no event shall NXP Semiconductors be liable for any indirect, incidental, punitive, special or consequential damages (including - without limitation - lost profits, lost savings, business interruption, costs related to the removal or replacement of any products or rework charges) whether or not such damages are based on tort (including negligence), warranty, breach of contract or any other legal theory.

Notwithstanding any damages that customer might incur for any reason whatsoever, NXP Semiconductors' aggregate and cumulative liability towards customer for the products described herein shall be limited in accordance with the *Terms and conditions of commercial sale* of NXP Semiconductors.

**Right to make changes** — NXP Semiconductors reserves the right to make changes to information published in this document, including without limitation specifications and product descriptions, at any time and without notice. This document supersedes and replaces all information supplied prior to the publication hereof.

**Suitability for use in automotive applications** — This NXP Semiconductors product has been qualified for use in automotive applications. Unless otherwise agreed in writing, the product is not designed, authorized or warranted to be suitable for use in life support, life-critical or safety-critical systems or equipment, nor in applications where failure or malfunction of an NXP Semiconductors product can reasonably be expected to result in personal injury, death or severe property or environmental damage. NXP Semiconductors and its suppliers accept no liability for inclusion and/or use of NXP Semiconductors products in such equipment or applications and therefore such inclusion and/or use is at the customer's own risk.

**Applications** — Applications that are described herein for any of these products are for illustrative purposes only. NXP Semiconductors makes no representation or warranty that such applications will be suitable for the specified use without further testing or modification.

Customers are responsible for the design and operation of their applications and products using NXP Semiconductors products, and NXP Semiconductors accepts no liability for any assistance with applications or customer product design. It is customer's sole responsibility to determine whether the NXP Semiconductors product is suitable and fit for the customer's applications and products planned, as well as for the planned application and use of customer's third party customer(s). Customers should provide appropriate design and operating safeguards to minimize the risks associated with their applications and products.

NXP Semiconductors does not accept any liability related to any default, damage, costs or problem which is based on any weakness or default in the customer's applications or products, or the application or use by customer's third party customer(s). Customer is responsible for doing all necessary testing for the customer's applications and products using NXP Semiconductors products in order to avoid a default of the applications and the products or of the application or use by customer's third party customer(s). NXP does not accept any liability in this respect.

**Limiting values** — Stress above one or more limiting values (as defined in the Absolute Maximum Ratings System of IEC 60134) will cause permanent damage to the device. Limiting values are stress ratings only and (proper) operation of the device at these or any other conditions above those given in the Recommended operating conditions section (if present) or the Characteristics sections of this document is not warranted. Constant or repeated exposure to limiting values will permanently and irreversibly affect the quality and reliability of the device.

**Terms and conditions of commercial sale** — NXP Semiconductors products are sold subject to the general terms and conditions of commercial sale, as published at <http://www.nxp.com/profile/terms>, unless otherwise agreed in a valid written individual agreement. In case an individual agreement is concluded only the terms and conditions of the respective agreement shall apply. NXP Semiconductors hereby expressly objects to applying the customer's general terms and conditions with regard to the purchase of NXP Semiconductors products by customer.

**No offer to sell or license** — Nothing in this document may be interpreted or construed as an offer to sell products that is open for acceptance or the grant, conveyance or implication of any license under any copyrights, patents or other industrial or intellectual property rights.

**Export control** — This document as well as the item(s) described herein may be subject to export control regulations. Export might require a prior authorization from competent authorities.

**Quick reference data** — The Quick reference data is an extract of the product data given in the Limiting values and Characteristics sections of this document, and as such is not complete, exhaustive or legally binding.

**Translations** — A non-English (translated) version of a document is for reference only. The English version shall prevail in case of any discrepancy between the translated and English versions.

## 20.4 Trademarks

Notice: All referenced brands, product names, service names and trademarks are the property of their respective owners.

## 21. Contact information

---

For more information, please visit: <http://www.nxp.com>

For sales office addresses, please send an email to: [salesaddresses@nxp.com](mailto:salesaddresses@nxp.com)



## 22. Contents

<b>1</b>	<b>General description</b> . . . . .	<b>1</b>	20.2	Definitions . . . . .	22
<b>2</b>	<b>Features and benefits</b> . . . . .	<b>1</b>	20.3	Disclaimers . . . . .	22
2.1	General . . . . .	1	20.4	Trademarks . . . . .	23
2.2	Low-power management . . . . .	2	<b>21</b>	<b>Contact information</b> . . . . .	<b>23</b>
2.3	Protection . . . . .	2	<b>22</b>	<b>Contents</b> . . . . .	<b>24</b>
<b>3</b>	<b>Quick reference data</b> . . . . .	<b>2</b>			
<b>4</b>	<b>Ordering information</b> . . . . .	<b>3</b>			
<b>5</b>	<b>Block diagram</b> . . . . .	<b>3</b>			
<b>6</b>	<b>Pinning information</b> . . . . .	<b>4</b>			
6.1	Pinning . . . . .	4			
6.2	Pin description . . . . .	4			
<b>7</b>	<b>Functional description</b> . . . . .	<b>5</b>			
7.1	Operating modes . . . . .	5			
7.1.1	Normal mode . . . . .	5			
7.1.2	Silent mode . . . . .	5			
7.1.3	Off mode . . . . .	6			
7.2	Fail-safe features . . . . .	6			
7.2.1	TXD dominant time-out function . . . . .	6			
7.2.2	Internal biasing of TXD, S and EN input pins . . . . .	6			
7.2.3	Undervoltage detection on pins $V_{CC}$ and $V_{IO}$ . . . . .	6			
7.2.4	Overtemperature protection . . . . .	6			
7.3	$V_{IO}$ supply pin . . . . .	6			
<b>8</b>	<b>Limiting values</b> . . . . .	<b>7</b>			
<b>9</b>	<b>Thermal characteristics</b> . . . . .	<b>7</b>			
<b>10</b>	<b>Static characteristics</b> . . . . .	<b>8</b>			
<b>11</b>	<b>Dynamic characteristics</b> . . . . .	<b>10</b>			
<b>12</b>	<b>Application information</b> . . . . .	<b>12</b>			
12.1	Application diagrams . . . . .	12			
12.2	Application hints . . . . .	12			
<b>13</b>	<b>Test information</b> . . . . .	<b>13</b>			
13.1	Quality information . . . . .	13			
<b>14</b>	<b>Package outline</b> . . . . .	<b>14</b>			
<b>15</b>	<b>Handling information</b> . . . . .	<b>16</b>			
<b>16</b>	<b>Soldering of SMD packages</b> . . . . .	<b>16</b>			
16.1	Introduction to soldering . . . . .	16			
16.2	Wave and reflow soldering . . . . .	16			
16.3	Wave soldering . . . . .	16			
16.4	Reflow soldering . . . . .	17			
<b>17</b>	<b>Soldering of HVSON packages</b> . . . . .	<b>18</b>			
<b>18</b>	<b>Appendix: ISO 11898-2:2016 parameter cross-reference list</b> . . . . .	<b>19</b>			
<b>19</b>	<b>Revision history</b> . . . . .	<b>21</b>			
<b>20</b>	<b>Legal information</b> . . . . .	<b>22</b>			
20.1	Data sheet status . . . . .	22			

Please be aware that important notices concerning this document and the product(s) described herein, have been included in section 'Legal information'.

© NXP N.V. 2017.

All rights reserved.

For more information, please visit: <http://www.nxp.com>

For sales office addresses, please send an email to: [salesaddresses@nxp.com](mailto:salesaddresses@nxp.com)

Date of release: 28 November 2017

Document identifier: TJA1051