



Parameter	Rating	Units
Blocking Voltage	230	V_P
Load Current	450	mA_{DC}/mA_{rms}
On-Resistance (max)	4	Ω

Features

- Integrated Active Current-Limit Protection
- Thermal Shutdown
- High Surge Capability
- Linear AC or DC Operation
- Low Power Consumption
- Clean, Bounce-free Switching
- Low Power Drive Requirements

Applications

- Instrumentation
- Elevator Load Control
- Fire Panels
- Security (alarms, horns, buzzers)
- Industrial Controls
- Medical Equipment
- Peripherals

Approvals

- UL 508 Certified Component: File E69938

Block Diagram

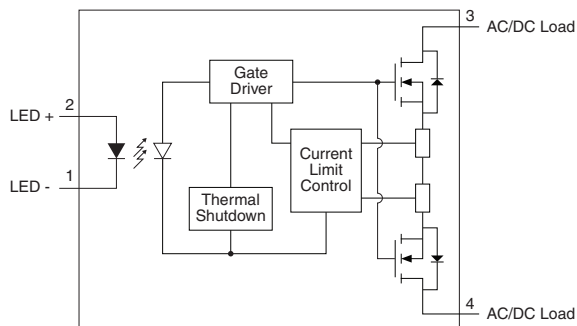

Pin #	Name	Description
1	LED -	Negative input to LED
2	LED +	Positive input to LED
3	AC/DC Load	Switch AC/DC terminal
4	AC/DC Load	Switch AC/DC terminal

Description

CPC1511 is a single-pole, normally open (1-Form-A) optically isolated Solid State Relay with integrated current limit and thermal shutdown features. Perfect for replacing electromechanical relays while enhancing the robustness of wireline-interface applications, the CPC1511 can carry loads up to $450mA_{DC}/mA_{rms}$.

The relay is constructed using an efficient LED for actuation control and an integrated monolithic die for the switch output. The die, fabricated in a high voltage dielectrically isolated technology comprises a photodiode array, switch control with active current limiting and thermal shutdown circuitry, and MOSFET switches.

CPC1511 incorporates thermal shutdown circuitry for improved survivability in harsh environments, and is designed to pass regulatory voltage surge requirements when provided with appropriate over voltage protection circuitry.

Designed specifically for environmentally demanding AC or DC applications where printed circuit board space is at a premium and additional power supplies are not available, the CPC1511 is an ideal solution.

Ordering Information

Part #	Description
CPC1511Y	4-Pin (8-Pin Body) Power SIP Package (25/Tube)

Pin Configuration

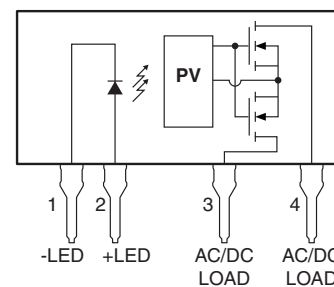

Switching Characteristics of Normally Open Devices

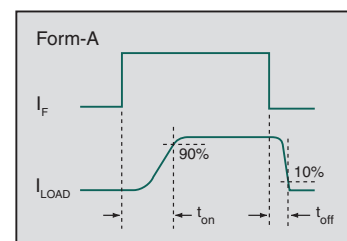

Absolute Maximum Ratings @ $T_A=25^{\circ}\text{C}$

Parameter	Ratings	Units
Blocking Voltage (V_{DRM})	230	V_P
Reverse Input Voltage	5	V
Input LED Current	50	mA
	0.9	A
Input Power Dissipation ¹	150	mW
Total Power Dissipation ²	1435	mW
ESD, Human Body Model	4	kV
Isolation Voltage, Input to Output	3750	V_{rms}
Operational Temperature	-40 to +85	$^{\circ}\text{C}$
Storage Temperature	-40 to +125	$^{\circ}\text{C}$

¹ Derate linearly 1.33 mW/ $^{\circ}\text{C}$
² Derate output linearly 14.3 mW/ $^{\circ}\text{C}$

Absolute maximum electrical ratings are at 25°C unless otherwise specified.

Absolute Maximum Ratings are stress ratings. Stresses in excess of these ratings can cause permanent damage to the device. Functional operation of the device at conditions beyond those indicated in the operational sections of this data sheet is not implied.

Electrical Characteristics @ $T_A=25^{\circ}\text{C}$

Unless otherwise specified, minimum and maximum values are guaranteed by production testing at 25°C only.

Typical values are characteristic of the device at 25°C , and are the result of engineering evaluations. They are provided for informational purposes only, and are not part of the manufacturing testing requirements.

Operating temperature range: $T_A = -40^{\circ}\text{C}$ to $+85^{\circ}\text{C}$.

Parameter	Conditions	Symbol	Min	Typ	Max	Units
Output Characteristics						
Current Limit	$I_F=5\text{mA}, V_L=\pm 10\text{V}, t=2\text{ms}$	I_{LMT}	0.7	-	1.4	A
On-Resistance ¹	$I_F=5\text{mA}, I_L=100\text{mA}$	R_{ON}	-	2.9	4	Ω
	$I_F=5\text{mA}, I_L=500\text{mA}$		-	2.8	4	
Off-State Leakage Current	$V_F=0\text{V}, V_L=230\text{V}$	I_{LEAK}	-	-	1	μA
Switching Speeds						
Turn-On	$I_F=5\text{mA}, I_L=100\text{mA}, V_L=10\text{V}$	t_{on}	-	0.7	4	ms
Turn-Off		t_{off}	-	0.11	2	
Output Capacitance	$I_F=0\text{mA}, V_L=1.0\text{V}, f=1\text{MHz}$	C_O	-	230	-	pF
Input Characteristics						
Input Control Current to Activate ²	$I_L=100\text{mA}$	I_F	-	1.3	2.5	mA
Input Control Current to Deactivate	$I_L=1\mu\text{A}$		0.2	-	-	
LED Forward Voltage	$I_F=5\text{mA}$	V_F	0.9	1.22	1.5	V
Common Characteristics						
Input to Output Capacitance	$f=1\text{MHz}$	C_{IO}	-	1	-	pF
Thermal Characteristics						
Thermal Shutdown	-	T_{SD}	120	132	140	$^{\circ}\text{C}$
Thermal Impedance (Junction to Ambient)	-	θ_{JA}	-	70	-	$^{\circ}\text{C}/\text{W}$
Thermal Characterization Parameter (Junction to Top)	-	Ψ_{JT}	-	13	-	$^{\circ}\text{C}/\text{W}$

¹ Measurement taken within 1 second of on-time.
² In noisy environments or for $T_A > 60^{\circ}\text{C}$, an input control current of 5mA is recommended.

PERFORMANCE DATA*

LED Forward Voltage Drop Distribution
(N=50, $I_F=5\text{mA}$)

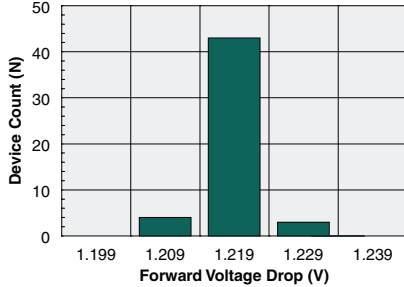

Typical I_F for Switch Operation
(N=50, $I_F=5\text{mA}$, $I_L=100\text{mA}_{DC}$)

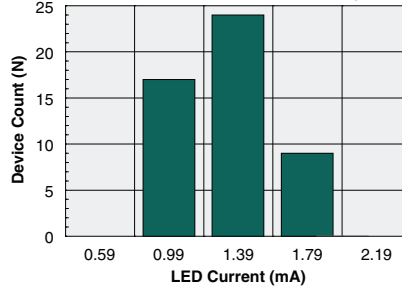

Typical I_F for Switch Dropout
(N=50, $I_F=5\text{mA}$, $I_L=100\text{mA}_{DC}$)

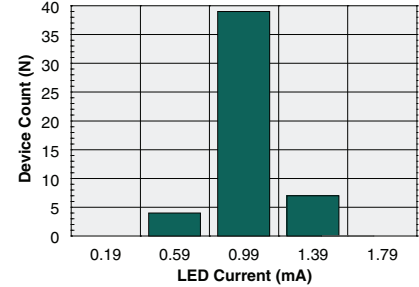

Typical On-Resistance Distribution
(N=50, $I_F=5\text{mA}$, $I_L=100\text{mA}_{DC}$)

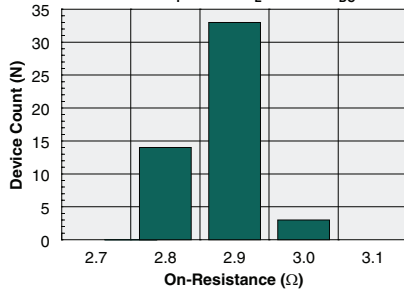

Typical Turn-On Time Distribution
(N=50, $I_F=5\text{mA}$, $I_L=100\text{mA}_{DC}$)

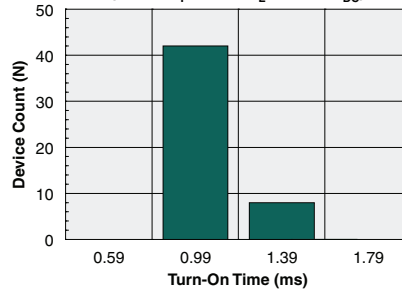

Typical Turn-Off Time Distribution
(N=50, $I_F=5\text{mA}$, $I_L=100\text{mA}_{DC}$)

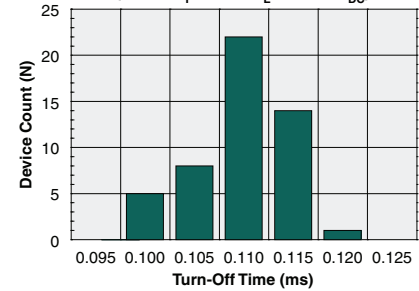

Typical Current Limit Distribution
(N=50, $I_F=5\text{mA}$)

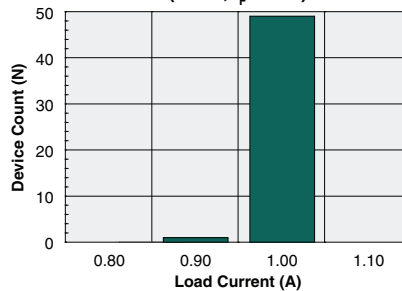

LED Forward Voltage Drop vs. Temperature

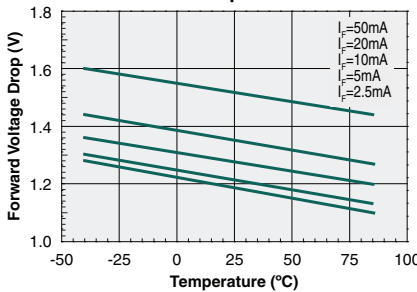

Typical I_F for Switch Operation vs. Temperature
($I_L=100\text{mA}$)

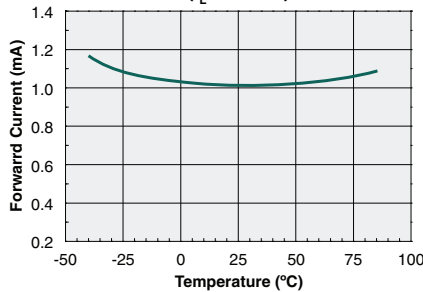

Typical I_F for Switch Dropout vs. Temperature
($I_L=1\mu\text{A}$)

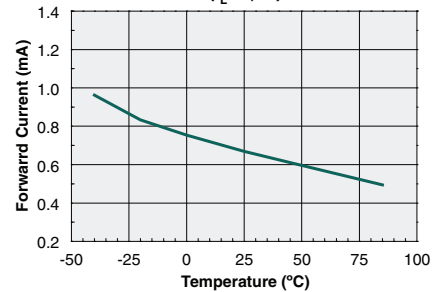

*The Performance data shown in the graphs above is typical of device operation. Unless otherwise noted, data is presented at 25°C. For guaranteed parameters not indicated in the written specifications, please contact our application department.

PERFORMANCE DATA*

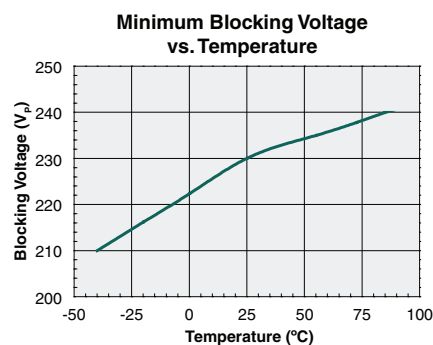
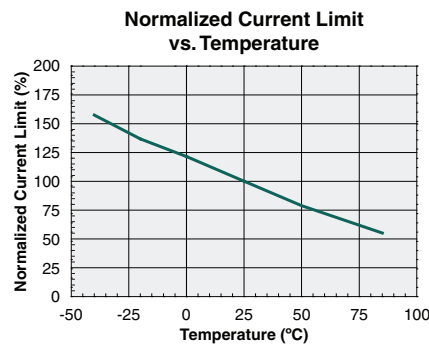
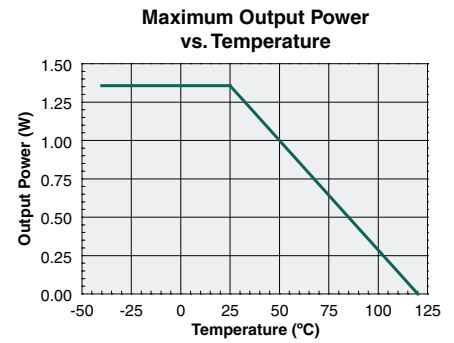
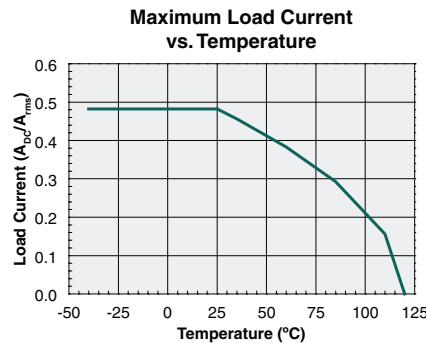
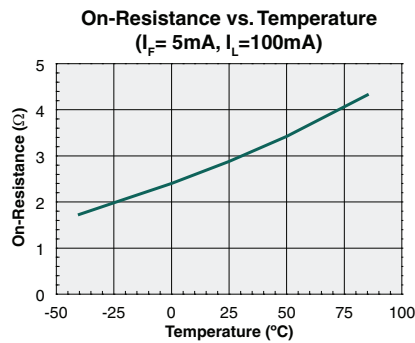
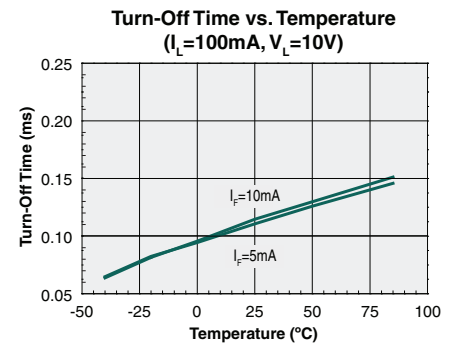
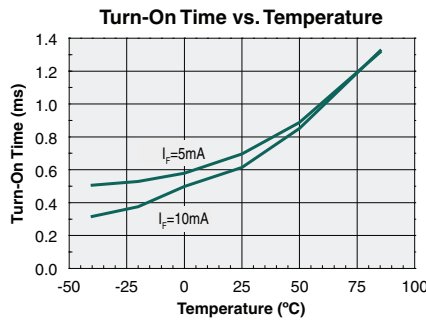
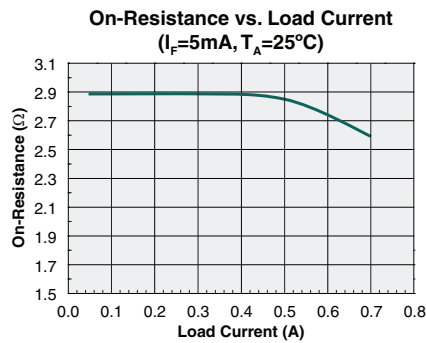
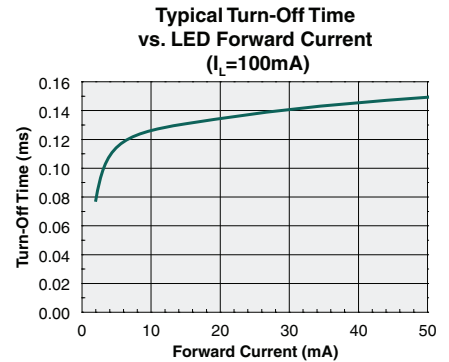
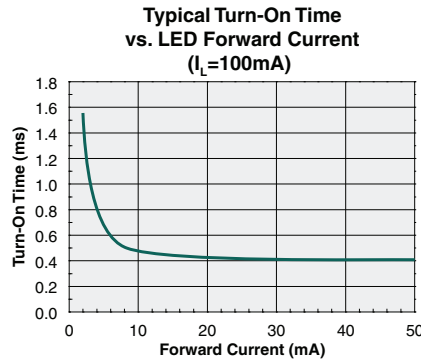
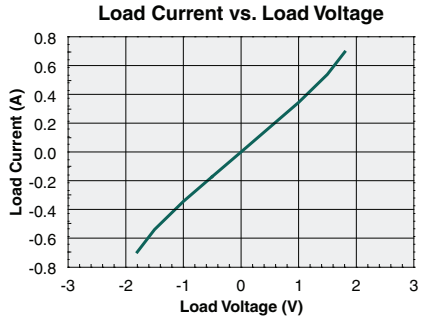

*The Performance data shown in the graphs above is typical of device operation. Unless otherwise noted, data is presented at 25°C. For guaranteed parameters not indicated in the written specifications, please contact our application department.

PERFORMANCE DATA*

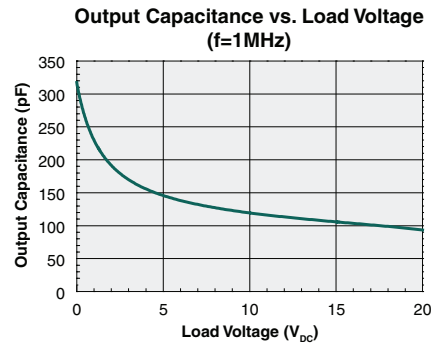
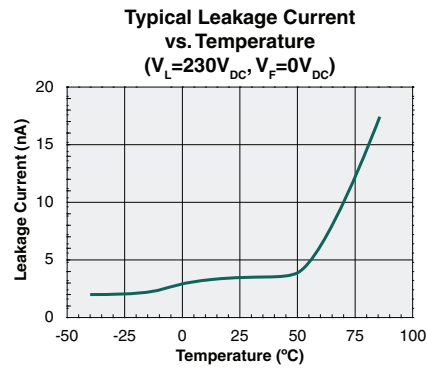

*The Performance data shown in the graphs above is typical of device operation. Unless otherwise noted, data is presented at 25°C. For guaranteed parameters not indicated in the written specifications, please contact our application department.

Manufacturing Information

Moisture Sensitivity



All plastic encapsulated semiconductor packages are susceptible to moisture ingress. IXYS Integrated Circuits Division classifies its plastic encapsulated devices for moisture sensitivity according to the latest version of the joint industry standard, **IPC/JEDEC J-STD-020**, in force at the time of product evaluation. We test all of our products to the maximum conditions set forth in the standard, and guarantee proper operation of our devices when handled according to the limitations and information in that standard as well as to any limitations set forth in the information or standards referenced below.

Failure to adhere to the warnings or limitations as established by the listed specifications could result in reduced product performance, reduction of operable life, and/or reduction of overall reliability.

This product carries a Moisture Sensitivity Level (MSL) classification as shown below, and should be handled according to the requirements of the latest version of the joint industry standard **IPC/JEDEC J-STD-033**.

Device	Moisture Sensitivity Level (MSL) Classification
CPC1511Y	MSL 1

ESD Sensitivity



This product is **ESD Sensitive**, and should be handled according to the industry standard **JESD-625**.

Soldering Profile

Provided in the table below is the Classification Temperature (T_C) of this product and the maximum dwell time the body temperature of this device may be ($T_C - 5$)°C or greater. The classification temperature sets the Maximum Body Temperature allowed for this device during lead-free reflow processes. For through-hole devices, and any other processes, the guidelines of **J-STD-020** must be observed.

Device	Classification Temperature (T_C)	Dwell Time (t_p)	Max Reflow Cycles
CPC1511Y	245°C	30 seconds	1

Board Wash

IXYS Integrated Circuits Division recommends the use of no-clean flux formulations. Board washing to reduce or remove flux residue following the solder reflow process is acceptable provided proper precautions are taken to prevent damage to the device. These precautions include, but are not limited to: using a low pressure wash and providing a follow up bake cycle sufficient to remove any moisture trapped within the device due to the washing process. Due to the variability of the wash parameters used to clean the board, determination of the bake temperature and duration necessary to remove the moisture trapped within the package is the responsibility of the user (assembler). Cleaning or drying methods that employ ultrasonic energy may damage the device and should not be used. Additionally, the device must not be exposed to flux or solvents that are Chlorine- or Fluorine-based.



Mechanical Dimensions

CPC1511Y Package

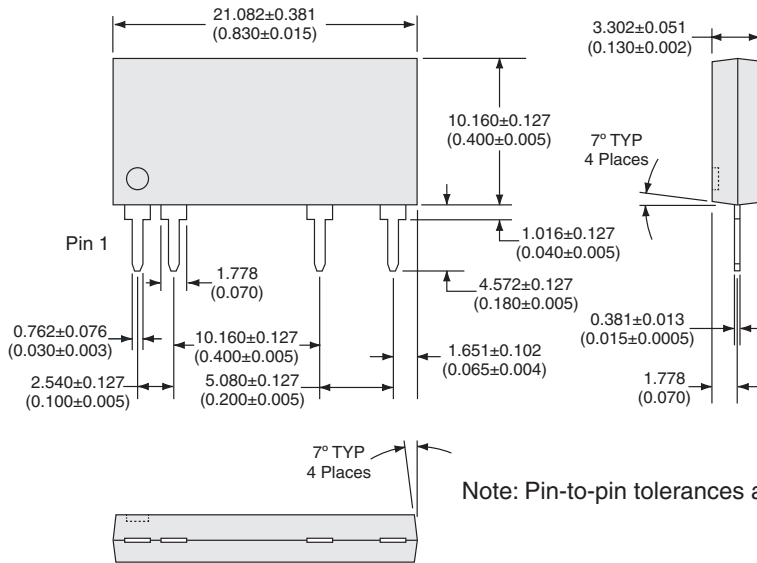

Note: Pin-to-pin tolerances are non-cumulative.

Dimensions
mm
(inches)

PCB Hole Pattern

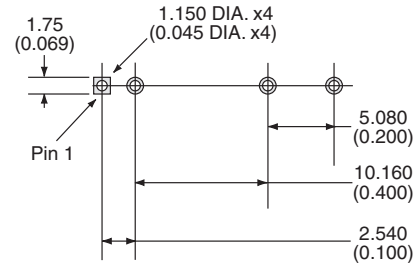

For additional information please visit our website at: www.ixysic.com

IXYS Integrated Circuits Division makes no representations or warranties with respect to the accuracy or completeness of the contents of this publication and reserves the right to make changes to specifications and product descriptions at any time without notice. Neither circuit patent licenses nor indemnity are expressed or implied. Except as set forth in IXYS Integrated Circuits Division's Standard Terms and Conditions of Sale, IXYS Integrated Circuits Division assumes no liability whatsoever, and disclaims any express or implied warranty, relating to its products including, but not limited to, the implied warranty of merchantability, fitness for a particular purpose, or infringement of any intellectual property right.

The products described in this document are not designed, intended, authorized or warranted for use as components in systems intended for surgical implant into the body, or in other applications intended to support or sustain life, or where malfunction of IXYS Integrated Circuits Division's product may result in direct physical harm, injury, or death to a person or severe property or environmental damage. IXYS Integrated Circuits Division reserves the right to discontinue or make changes to its products at any time without notice.