

0.3 Ω , Low Voltage Dual SPDT Analog Switches

DESCRIPTION

The DG2535E and DG2733E are low voltage, low on-resistance, dual single-pole/double-throw (SPDT) monolithic CMOS analog switches designed for high performance switching of analog signals. Combining low-power, high speed, low on-resistance, and small package size, the DG2535E and DG2733E are ideal for portable and battery powered applications.

The DG2535E and DG2733E have an operation range from 1.65 V to 5.5 V single supply. The DG2535E has two separate control pins for independent control of the two SPDT switches. The DG2733E has an EN pin to enable the device when the logic is high.

The DG2535E and DG2733E have guaranteed 1.65 V logic compatible, allowing easy interface with low voltage DSP or MCU control logic.

The switches conduct signals within the power rails equally well in both directions when on, and blocks up to the power supply level when off. Break-before-make is guaranteed.

The DG2535E and DG2733E are built on Vishay Siliconix's sub micron CMOS low voltage process technology and provide greater than 400 mA latch-up protection, as tested per JESD78A.

The DG2535E and DG2733E are available in lead (Pb)-free 10-lead DFN and SOIC packages.

FEATURES

- 1.65 V to 5.5 V single power operation
- 0.3 Ω typ. switch on resistance at $V_+ = 5$ V
- Fast switching:
 $t_{ON} = 55$ ns at 2.7 V, $t_{OFF} = 15$ ns at 2.7 V
- Latch-up current > 400 mA (JESD78)
- Material categorization: for definitions of compliance please see www.vishay.com/doc?99912



RoHS
COMPLIANT
HALOGEN
FREE

BENEFITS

- Low switch resistance
- Low voltage logic compatible
- Wide operation voltage range
- Fast switching time

APPLICATIONS

- Audio and video signal routing
- Battery operated systems
- Relay replacement
- Automatic test equipment
- Process control and automation
- Data acquisition systems
- Meters and instruments
- Medical and healthcare systems
- PCMCIA cards
- Communication systems

FUNCTIONAL BLOCK DIAGRAM AND PIN CONFIGURATION

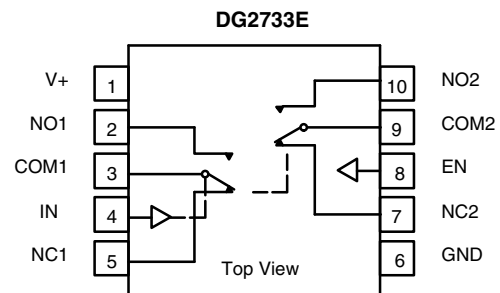
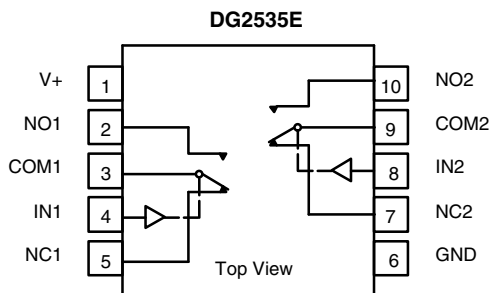

TRUTH TABLE DG2535E		
IN1, IN2	NC1, NC2	NO1, NO2
0	ON	OFF
1	OFF	ON

TRUTH TABLE DG2733E			
IN	EN	NC1, NC2	NO1, NO2
0	1	ON	OFF
1	1	OFF	ON
0	0	OFF	OFF
1	0	OFF	OFF



ORDERING INFORMATION		
TEMP. RANGE	PACKAGE	PART NUMBER
-40 °C to +85 °C	MSOP10	DG2535EDQ-T1-GE3
		DG2733EDQ-T1-GE3
	DFN-10	DG2535EDN-T1-GE4
		DG2733EDN-T1-GE4

ABSOLUTE MAXIMUM RATINGS (T _A = 25 °C, unless otherwise noted)				
PARAMETER		SYMBOL	LIMIT	UNIT
Reference to GND	V+		-0.3 V to +6 V	V
	IN, COM, NC, NO ^a		-0.3 V to (V+ + 0.3)	
Current (any terminal except NO, NC or COM)			30	mA
Continuous current (NO, NC, or COM)			± 300	
Peak current (pulsed at 1 ms, 10 % duty cycle)			± 500	
Storage temperature (D suffix)			-65 to +150	°C
Power dissipation (packages) ^b	miniQFN10 ^c		208	mW
Latch up current		JESD78A	> 400	mA
ESD - HBM		ANSI / ESDA / JEDEC® JS-001	> 5000	V
ESD - CDM		JESD22-C101	> 1000	
ESD - MM		JESD22-A115	> 200	

Notes

- a. Signals on NC, NO, or COM or IN exceeding V+ will be clamped by internal diodes. Limit forward diode current to maximum current ratings.
- b. All leads welded or soldered to PC board.
- c. Derate 4 mW/C above 70 °C.

Stresses beyond those listed under "Absolute Maximum Ratings" may cause permanent damage to the device. These are stress ratings only, and functional operation of the device at these or any other conditions beyond those indicated in the operational sections of the specifications is not implied. Exposure to absolute maximum rating conditions for extended periods may affect device reliability.



SPECIFICATIONS										
PARAMETER	SYMBOL	TEST CONDITIONS UNLESS OTHERWISE SPECIFIED $V_+ = 3\text{ V}, \pm 10\%, V_{IN} = 0.4\text{ V}$ or 1.65 V^e	TEMP. ^a	LIMITS -40 °C to +85 °C			UNIT			
				MIN. ^b	TYP. ^c	MAX. ^b				
Analog Switch										
Analog signal range ^d	V_{analog}	$R_{\text{DS(on)}}$	Full	0	-	V_+	V			
On-resistance	$R_{\text{DS(on)}}$	$V_+ = 2.7\text{ V}, I_{\text{NO/NC}} = 100\text{ mA}, V_{\text{COM}} = 0.5\text{ V}$	Room	-	0.5	0.7	Ω			
		$V_+ = 2.7\text{ V}, I_{\text{NO/NC}} = 100\text{ mA}, V_{\text{COM}} = 1.5\text{ V}$	Full	-	0.6	-				
		$V_+ = 2.7\text{ V}, I_{\text{NO/NC}} = 100\text{ mA}, V_{\text{COM}} = 0.5\text{ V}$		Room	-	0.3		0.5		
		$V_+ = 2.7\text{ V}, I_{\text{NO/NC}} = 100\text{ mA}, V_{\text{COM}} = 1.5\text{ V}$	Full	-	0.25	-				
		$V_+ = 5.5\text{ V}, I_{\text{NO/NC}} = 100\text{ mA}, V_{\text{COM}} = 0.9\text{ V}$		Room	-	0.4		-		
		$V_+ = 5.5\text{ V}, I_{\text{NO/NC}} = 100\text{ mA}, V_{\text{COM}} = 2.5\text{ V}$	Full	-	-	-				
		$V_+ = 5.5\text{ V}, I_{\text{NO/NC}} = 100\text{ mA}, V_{\text{COM}} = 0.9\text{ V}$		Room	-	-		-		
$V_+ = 5.5\text{ V}, I_{\text{NO/NC}} = 100\text{ mA}, V_{\text{COM}} = 2.5\text{ V}$	Full	-	-	-						
R_{ON} match ^d	ΔR_{ON}	$V_+ = 2.7\text{ V}, I_{\text{NO/NC}} = 100\text{ mA}, V_{\text{COM}} = 0.5\text{ V}, 1.5\text{ V}$ $V_+ = 5.5\text{ V}, I_{\text{NO/NC}} = 100\text{ mA}, V_{\text{COM}} = 0.9\text{ V}, 2.5\text{ V}$	Room	-	0.06	0.08				
R_{ON} resistance flatness ^d	R_{ON} flatness	$V_+ = 2.7\text{ V}, I_{\text{NO/NC}} = 100\text{ mA}, V_{\text{COM}} = 0.5\text{ V}, 1.5\text{ V}$	Room	-	-	0.15				
Switch off leakage current	$I_{\text{NO/NC(off)}}$	$V_+ = 5\text{ V}, V_{\text{NO/NC}} = 0.5\text{ V} / 4.5\text{ V}, V_{\text{COM}} = 4.5\text{ V} / 0.5\text{ V}$	Room	-8	-	8	nA			
	$I_{\text{COM(off)}}$		Full	-50	-	50				
			Room	-8	-	8				
	Full		-50	-	50					
Channel-on leakage current	$I_{\text{COM(on)}}$	$V_+ = 5\text{ V}, V_{\text{NO/NC}} = V_{\text{COM}} = 4.5\text{ V} / 0.5\text{ V}$	Room	-10	-	10				
			Full	-50	-	50				
Digital Control										
Input high voltage	V_{INH}	$V_+ = 3\text{ V}$	Full	1.65	-	-	V			
Input low voltage	V_{INL}		Full	-	-	0.4				
Input high voltage	V_{INH}	$V_+ = 5\text{ V}$	Full	1.8	-	-				
Input low voltage	V_{INL}		Full	-	-	0.6				
Input capacitance	C_{IN}		Full	-	6	-	pF			
Input current	I_{INL} or I_{INH}	$V_{\text{IN}} = 0$ or V_+	Full	-1	-	1	μA			
Dynamic Characteristics										
Break-Before-Make time ^e	t_{BBM}	$V_+ = 3.6\text{ V}, V_{\text{NO}}, V_{\text{NC}} = 1.5\text{ V}, R_{\text{L}} = 50\ \Omega, C_{\text{L}} = 35\text{ pF}$	Room	1	15	-	ns			
Turn-on time ^e	t_{ON}		Room	-	28	78				
			Full	-	-	80				
Turn-off time ^e	t_{OFF}		Room	-	13	58				
			Full	-	-	60				
Off-isolation ^d	OIRR		$R_{\text{L}} = 50\ \Omega, C_{\text{L}} = 5\text{ pF}, f = 100\text{ kHz}$	Room	-	-70		-	dB	
Crosstalk ^d	X_{TALK}	Room		-	-90	-				
3 dB bandwidth ^d		$R_{\text{L}} = 50\ \Omega, C_{\text{L}} = 5\text{ pF}$	Room	-	120	-	MHz			
NO, NC off capacitance ^d	$C_{\text{NO(off)}}$	$V_{\text{IN}} = 0\text{ V},$ or $V_+, f = 1\text{ MHz}$	Room	-	40	-	pF			
	$C_{\text{NC(off)}}$			-	40	-				
Channel on capacitance ^d	$C_{\text{NO(on)}}$			-	120	-				
	$C_{\text{NC(on)}}$			-	120	-				
Power Supply										
Power supply range	V_+				-	1.65		-	5.5	V
Power supply current	I_+	$V_{\text{IN}} = 0$ or V_+	Full	-	-	1	μA			

Notes

- a. Room = 25 °C, Full = as determined by the operating suffix.
- b. The algebraic convention whereby the most negative value is a minimum and the most positive a maximum, is used in this datasheet.
- c. Typical values are for design aid only, not guaranteed nor subject to production testing.
- d. Guarantee by design, not subjected to production test.
- e. V_{IN} = input voltage to perform proper function.



TYPICAL CHARACTERISTICS ($T_A = 25\text{ }^\circ\text{C}$, unless otherwise noted)



RON vs. VCOM and Supply Voltage

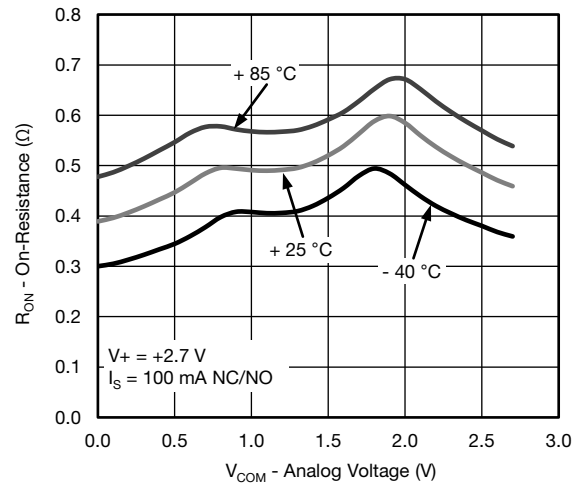

RON vs. Analog Voltage and Temperature



RON vs. Analog Voltage and Temperature

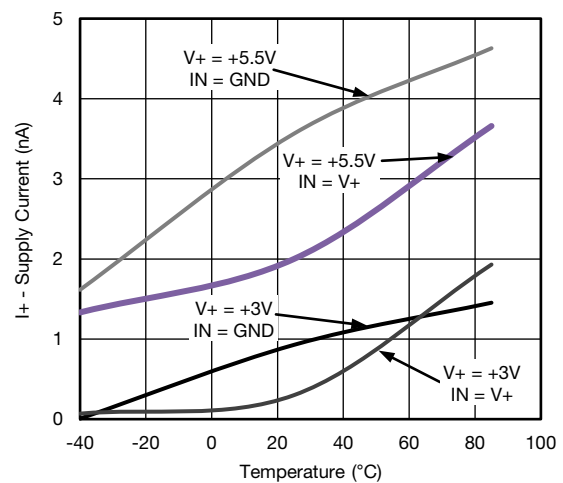

Supply Current vs. Temperature



TYPICAL CHARACTERISTICS (T_A = 25 °C, unless otherwise noted)

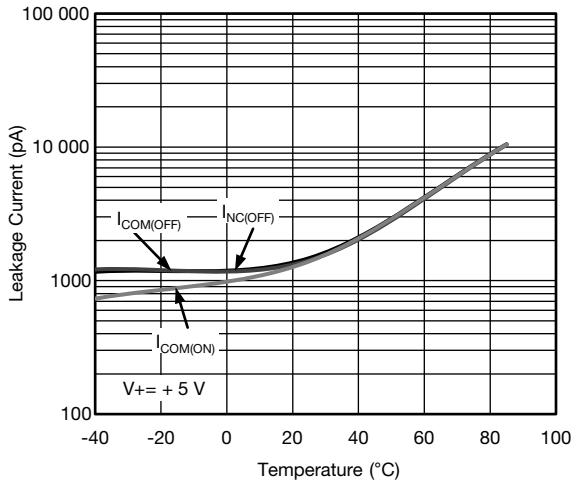

Leakage Current vs. Temperature



Switching Time vs. Temperature

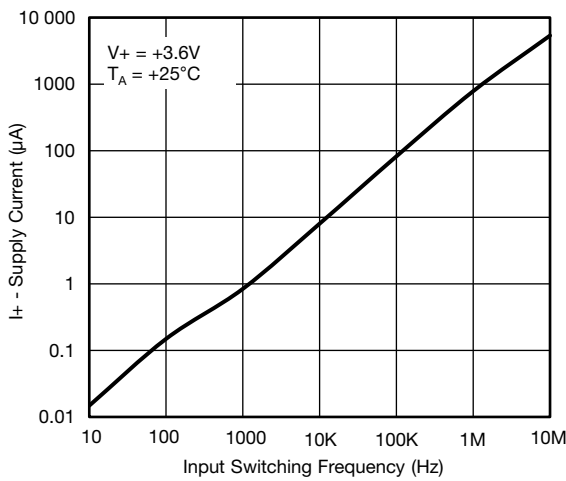

Supply Current vs. Switching Frequency

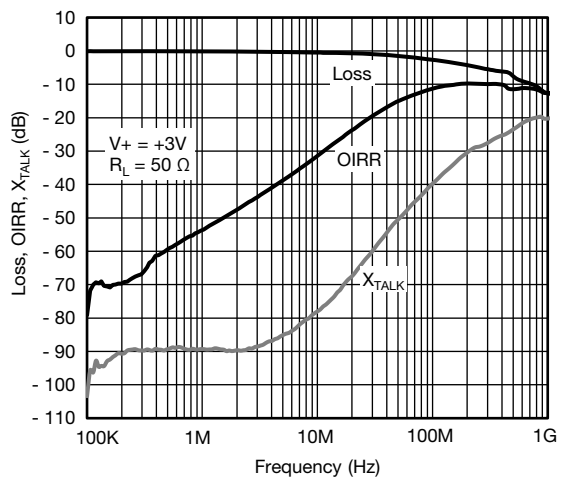

Insertion Loss, Off-Isolation Crosstalk vs. Frequency

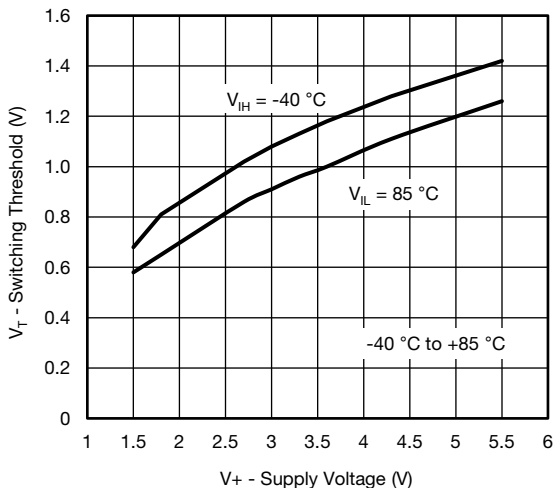

Switching Threshold vs. Supply Voltage



Supply Current vs. V_{IN}

TEST CIRCUITS

C_L (includes fixture and stray capacitance)

$$V_{OUT} = V_{COM} \left(\frac{R_L}{R_L + R_{ON}} \right)$$



Logic "1" = Switch On
 Logic input waveforms inverted for switches that have the opposite logic sense.

Fig. 1 - Switching Time

C_L (includes fixture and stray capacitance)

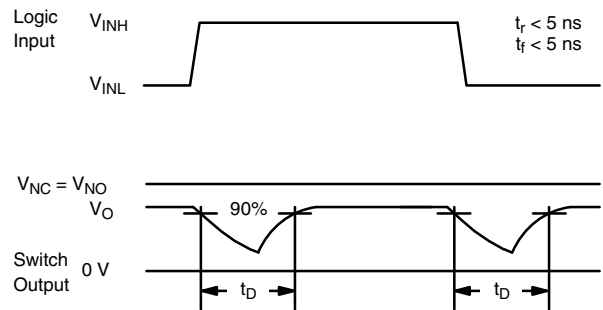
Fig. 2 - Break-Before-Make Interval

TEST CIRCUITS



IN depends on switch configuration: input polarity determined by sense of switch.

Fig. 3 - Charge Injection



Fig. 4 - Off-Isolation



Fig. 5 - Channel Off/On Capacitance

Vishay Siliconix maintains worldwide manufacturing capability. Products may be manufactured at one of several qualified locations. Reliability data for Silicon Technology and Package Reliability represent a composite of all qualified locations. For related documents such as package/tape drawings, part marking, and reliability data, see www.vishay.com/ppg?75646.



MSOP: 10-LEADS

JEDEC Part Number: MO-187, (Variation AA and BA)

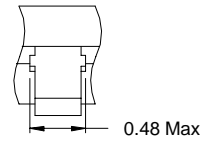

Detail "B"
(Scale: 30/1)
Dambar Protrusion

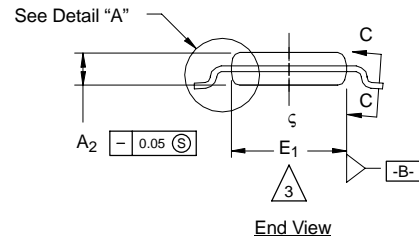
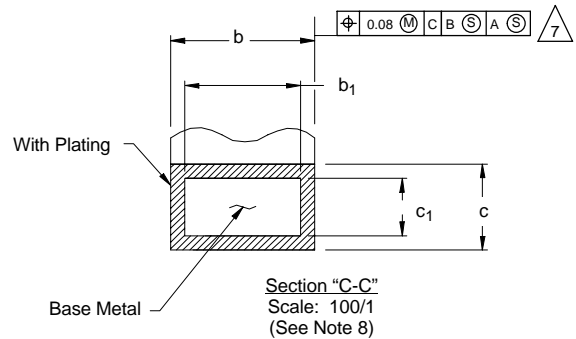

NOTES:

- Die thickness allowable is 0.203 ± 0.0127 .
- Dimensioning and tolerances per ANSI.Y14.5M-1994.
- Dimensions "D" and "E₁" do not include mold flash or protrusions, and are measured at Datum plane [-H-], mold flash or protrusions shall not exceed 0.15 mm per side.
- Dimension is the length of terminal for soldering to a substrate.
- Terminal positions are shown for reference only.
- Formed leads shall be planar with respect to one another within 0.10 mm at seating plane.
- The lead width dimension does not include Dambar protrusion. Allowable Dambar protrusion shall be 0.08 mm total in excess of the lead width dimension at maximum material condition. Dambar cannot be located on the lower radius or the lead foot. Minimum space between protrusions and an adjacent lead to be 0.14 mm. See detail "B" and Section "C-C".
- Section "C-C" to be determined at 0.10 mm to 0.25 mm from the lead tip.
- Controlling dimension: millimeters.
- This part is compliant with JEDEC registration MO-187, variation AA and BA.
- Datums [-A-] and [-B-] to be determined Datum plane [-H-].
- Exposed pad area in bottom side is the same as teh leadframe pad size.

N = 10L

Dim	MILLIMETERS			Note
	Min	Nom	Max	
A	-	-	1.10	
A ₁	0.05	0.10	0.15	
A ₂	0.75	0.85	0.95	
b	0.17	-	0.27	8
b ₁	0.17	0.20	0.23	8
c	0.13	-	0.23	
c ₁	0.13	0.15	0.18	
D	3.00 BSC			3
E	4.90 BSC			
E ₁	2.90	3.00	3.10	3
e	0.50 BSC			
e ₁	2.00 BSC			
L	0.40	0.55	0.70	4
N	10			5
α	0°	4°	6°	
ECN: T-02080—Rev. C, 15-Jul-02 DWG: 5867				

DFN-10 LEAD (3 X 3)

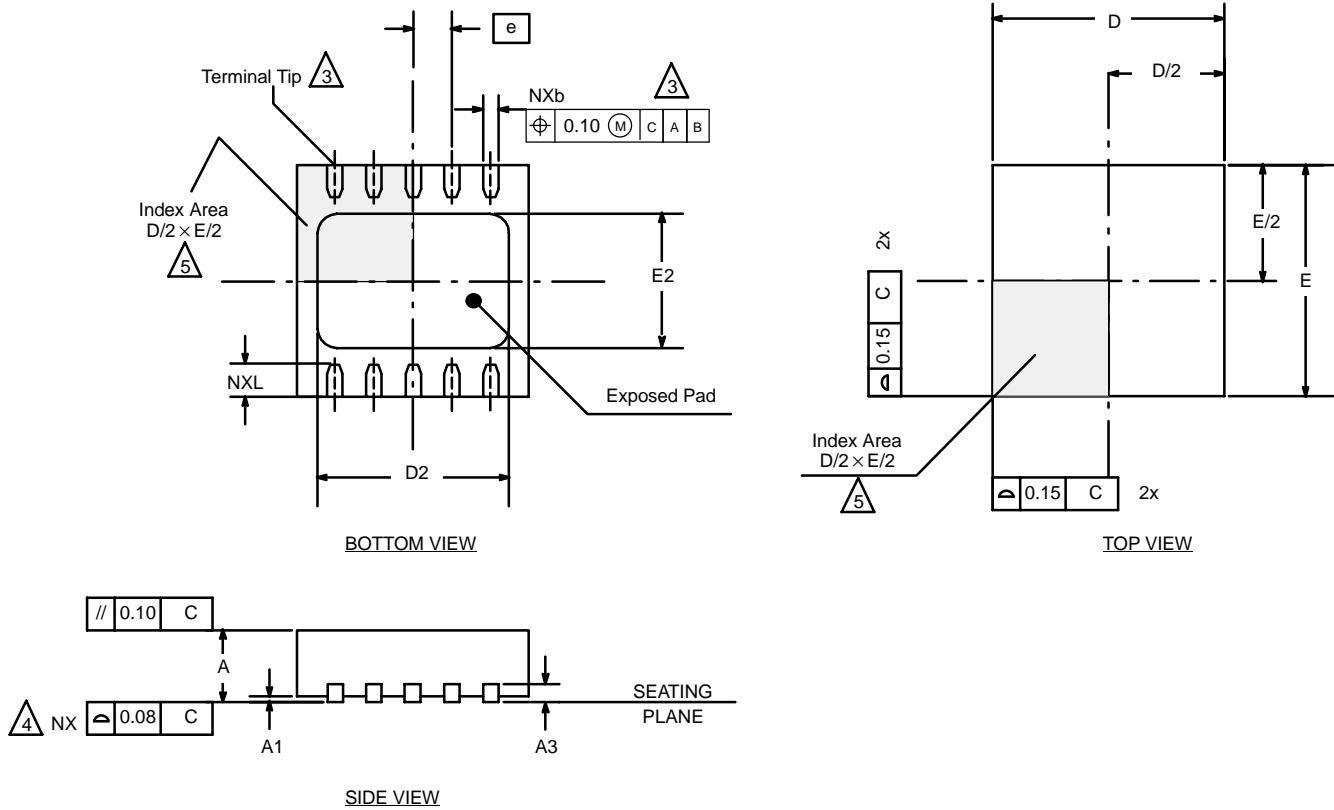

NOTES:

- All dimensions are in millimeters and inches.
- N is the total number of terminals.
- (3) Dimension b applies to metallized terminal and is measured between 0.15 and 0.30 mm from terminal tip.
- (4) Coplanarity applies to the exposed heat sink slug as well as the terminal.
- (5) The pin #1 identifier may be either a mold or marked feature, it must be located within the zone indicated.

Dim	MILLIMETERS			INCHES		
	Min	Nom	Max	Min	Nom	Max
A	0.80	0.90	1.00	0.031	0.035	0.039
A1	0.00	0.02	0.05	0.000	0.001	0.002
A3	0.20 BSC			0.008 BSC		
b	0.18	0.23	0.30	0.007	0.009	0.012
D	3.00 BSC			0.118 BSC		
D2	2.20	2.38	2.48	0.087	0.094	0.098
E	3.00 BSC			0.118 BSC		
E2	1.49	1.64	1.74	0.059	0.065	0.069
e	0.50 BSC			0.020 BSC		
L	0.30	0.40	0.50	0.012	0.016	0.020

*Use millimeters as the primary measurement.

ECN: S-42134—Rev. A, 29-Nov-04
DWG: 5943



Disclaimer

ALL PRODUCT, PRODUCT SPECIFICATIONS AND DATA ARE SUBJECT TO CHANGE WITHOUT NOTICE TO IMPROVE RELIABILITY, FUNCTION OR DESIGN OR OTHERWISE.

Vishay Intertechnology, Inc., its affiliates, agents, and employees, and all persons acting on its or their behalf (collectively, "Vishay"), disclaim any and all liability for any errors, inaccuracies or incompleteness contained in any datasheet or in any other disclosure relating to any product.

Vishay makes no warranty, representation or guarantee regarding the suitability of the products for any particular purpose or the continuing production of any product. To the maximum extent permitted by applicable law, Vishay disclaims (i) any and all liability arising out of the application or use of any product, (ii) any and all liability, including without limitation special, consequential or incidental damages, and (iii) any and all implied warranties, including warranties of fitness for particular purpose, non-infringement and merchantability.

Statements regarding the suitability of products for certain types of applications are based on Vishay's knowledge of typical requirements that are often placed on Vishay products in generic applications. Such statements are not binding statements about the suitability of products for a particular application. It is the customer's responsibility to validate that a particular product with the properties described in the product specification is suitable for use in a particular application. Parameters provided in datasheets and / or specifications may vary in different applications and performance may vary over time. All operating parameters, including typical parameters, must be validated for each customer application by the customer's technical experts. Product specifications do not expand or otherwise modify Vishay's terms and conditions of purchase, including but not limited to the warranty expressed therein.

Except as expressly indicated in writing, Vishay products are not designed for use in medical, life-saving, or life-sustaining applications or for any other application in which the failure of the Vishay product could result in personal injury or death. Customers using or selling Vishay products not expressly indicated for use in such applications do so at their own risk. Please contact authorized Vishay personnel to obtain written terms and conditions regarding products designed for such applications.

No license, express or implied, by estoppel or otherwise, to any intellectual property rights is granted by this document or by any conduct of Vishay. Product names and markings noted herein may be trademarks of their respective owners.