

28 V, 56 mΩ, Load Switch with Programmable Current Limit and Slew Rate Control

OPERATION DESCRIPTION

The SiP32429 is a load switch that integrates multiple control features that simplify the design and increase the reliability of the circuitry connected to the switch. The SiP32429 is a 56 mΩ switch designed to operate in the 6 V to 28 V range. An internally generated gate drive voltage ensures good R_{ON} linearity over the input voltage operating range.

The SiP32429 has a slew rate control circuit that controls the switch turn on time to the value set by an external capacitor. After soft start, an over current protection circuit (OCP) continuously monitors the current through the load switch, and controls the switch impedance to limit the current to the level programmed by an external resistor. If the overcurrent condition persists for more than 7 ms, the switch shuts off automatically. The SiP32429 has an over temperature protection circuit (OTP) which will shut the switch off if the junction temperature exceeds 137 °C. The OTP circuit will release the switch when the temperature has decreased by about 39 °C of hysteresis.

When an OCP or an OTP fault condition is detected the \overline{FLG} pin is pulled low. The fault flag will release 150 ms after the fault condition is cleared, and the switch will automatically turn on at the programmed slew rate.

The device features a low voltage control logic interface which can be controlled without the need for level shifting. The device also includes a power good flag.

SiP32429 is available in a space efficient DFN10 3 mm x 3 mm package.

FEATURES

- 6 V to 28 V operation
- Programmable soft start
- Programmable current limit
- Over temperature protection
- ON resistance 56 mΩ
- Power good, when V_{OUT} reaches 90 % of V_{IN}
- Fault flag
- Under voltage lockout: 4.8 V/5.4 V (typ./max.)
- Package: DFN10 3 mm x 3 mm
- SiP32429 will turn OFF the switch under fault conditions, and re-try to turn on through the full soft start procedure 150 ms after the switch is off and the fault removed.
- Material categorization: For definitions of compliance please see www.vishay.com/doc?99912



RoHS
COMPLIANT
HALOGEN
FREE
Available

APPLICATIONS

- Personal Computers
- Lighting
- Flat panel displays
- Game Consoles
- Industrial
- Network communication
- Data storage

TYPICAL APPLICATION CIRCUIT

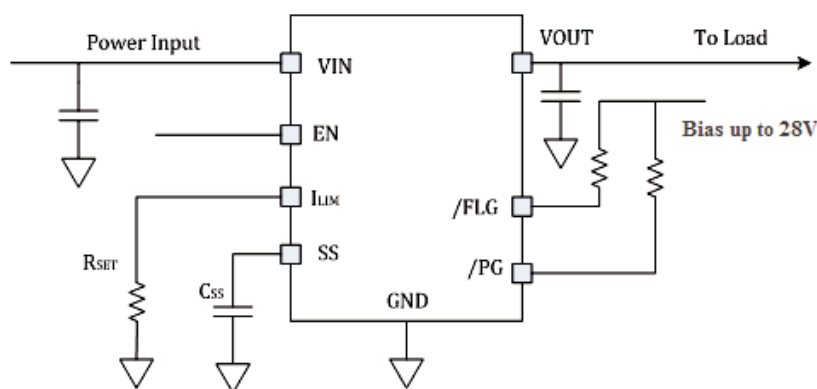

Figure 1 - SiP32429 Typical Application Circuit

ORDERING INFORMATION

Temperature Range	Package	Marking	Part Number
- 40 °C to 85 °C	DFN10 3 mm x 3 mm	2429	SiP32429DNP-T1-GE4

Note:

GE4 denotes halogen-free and RoHS-compliant

ABSOLUTE MAXIMUM RATINGS

Parameter	Limit	Unit
Input Voltage (V_{IN})	- 0.3 to 30	V
Output Voltage (V_{OUT})	- 0.3 to $V_{IN} + 0.3$ V	
\overline{PG} Voltage	- 0.3 to 30	
\overline{FLG} Voltage	- 0.3 to 30	
EN Voltage	- 0.3 to 6	
Maximum Continuous Switch Current	4.5	A
Maximum Junction Temperature	150	°C
Storage Temperature	- 55 to 150	
Thermal Resistance (θ_{JA}) ^a	88	°C/W
Power Dissipation (P_D) ^{a,b}	1.42	W

Notes:

a) Device mounted with all lead and power pad soldered or welded to PCB.

b) Derate 11.4 mW/°C above $T_A = 25$ °C.

Stresses beyond those listed under "Absolute Maximum Ratings" may cause permanent damage to the device. These are stress ratings only, and functional operation of the device at these or any other conditions beyond those indicated in the operational sections of the specifications is not implied. Exposure to absolute maximum rating/conditions for extended periods may affect device reliability.

RECOMMENDED OPERATING RANGE

Parameter	Limit	Unit
Input Voltage (V_{IN})	6 to 28	V
V_{SS}	0 to 6	
V_{OUT}	0 V to 28	
EN	0 to 6	
\overline{FLG} , \overline{PG}	0 to V_{IN}	
I_{LIM}	0 to 6	
Current Limit	0.75 to 3.5	A
Operating Temperature Range	- 40 to 85	°C

SPECIFICATIONS							
Parameter	Symbol	Test Conditions Unless Specified $V_{IN} = 12\text{ V}$, $V_{EN} = 2.4\text{ V}$, $T_A = 25\text{ }^\circ\text{C}$	Temp.	Min.	Typ.	Max.	Unit
Power Input Voltage	V_{IN}		-	6	-	28	V
Quiescent Current	I_Q	$I_{OUT} = 0\text{ A}$, and device enabled	-	-	170	300	μA
Shutdown Current	I_{SD}	$I_{OUT} = 0\text{ A}$, and device disabled	-	-	12	20	
Switch OFF Leakage	$I_{(OFF)}$	$V_{IN} = 28\text{ V}$, $V_{OUT} = 0\text{ V}$ (current measured at output)	-	-	-	1	
Current Limit Accuracy		$R_{SET} = 4.1\text{ k}\Omega$	-40 °C to 85 °C	1.2	1.5	1.8	A
Switch On Resistance	$R_{DS(ON)}$	$I_{SW} = 500\text{ mA}$	-	-	56	72	m Ω
Soft Start Charge Current	I_{SS}	Constant current source	-	-	4.5	-	μA
Turn ON Delay Time	T_{ONDLY}	50 % V_{EN} to 50 % V_{OUT} $C_{SS} = \text{open}$, $R_L = 10\text{ }\Omega$, $C_{OUT} = 10\text{ }\mu\text{F}$	-	-	550	-	μs
Turn ON Rise Time	T_R	$C_{SS} = \text{open}$, $R_L = 10\text{ }\Omega$, $C_{OUT} = 10\text{ }\mu\text{F}$	-	-	400	-	ms
		$C_{SS} = 47\text{ nF}$, $R_L = 10\text{ }\Omega$, $C_{OUT} = 10\text{ }\mu\text{F}$	-	-	7	-	
		$C_{SS} = 47\text{ nF}$, no R_L , $C_{OUT} = 10\text{ }\mu\text{F}$	-	-	2	-	
Turn Off Delay	T_{OFFDLY}		-	-	1	-	μs
Current Limit Response Time			-	-	20	-	
Short Circuit Response Time			-	-	1	-	
OC Flag Blanking Time/Switch OFF delay under OC			-40 °C to 85 °C	4	-	-	ms
Auto re-try time			-	-	150	-	
Input Logic High Voltage	V_{ENH}	$V_{IN} = 6\text{ V to }28\text{ V}$	-40 °C to 85 °C	1.5	-	-	V
Input Logic Low Voltage	V_{ENL}		-40 °C to 85 °C	-	-	0.6	
Input Pull Down Resistor	R_{EN}	$V_{EN} = 5\text{ V}$	-	-	2.5	-	M Ω
Power Good Trip Voltage			-	-	90 % x V_{IN}	-	V
Power Good Hysteresis			-	-	3 % x V_{IN}	-	
$\overline{\text{PG}}$ and $\overline{\text{FLG}}$ Output Logic Low Voltage		$I_{SINK} = 1\text{ mA}$	-	-	< 0.1	-	
$\overline{\text{PG}}$ and $\overline{\text{FLG}}$ Output High Leakage		V_{PG} , $V_{FLG} = 28\text{ V}$	-	-	-	1	μA
UVLO Threshold			-	-	4.8	5.4	V
UVLO Hysteresis			-	-	0.28	-	
Thermal Shutdown Threshold			-	-	137	-	°C
Thermal Shut down Hysteresis			-	-	39	-	

PIN CONFIGURATION

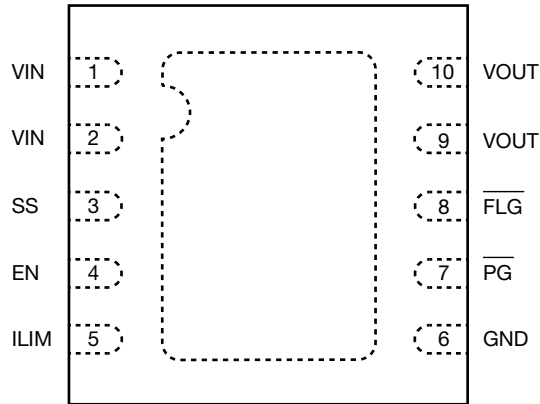

Figure 2 - DFN10 3 mm x 3 mm Package
Top View

PIN DESCRIPTION		
Pin Number	Name	Function
1	V_{IN}	Power Input
2	V_{IN}	Power Input
3	SS	Soft-Start Pin. Connect a Capacitor from SS to GND to Program the Soft-Start Time. Leave SS open to set the Default Soft-Start Time of 400 μ s.
4	EN	Enable Input. Logic High Enabled
5	I_{LIM}	Current Limit Setting Pin. Connect R_{SET} Resistor to GND
6	GND	Ground
7	\overline{PG}	Power Good
8	\overline{FLG}	Fault Condition Flag
9	V_{OUT}	Switch Output
10	V_{OUT}	Switch Output
Central Pad		Connect this Pad to GND or leave it floating

TYPICAL CHARACTERISTICS (internally regulated, 25 °C, unless otherwise noted)

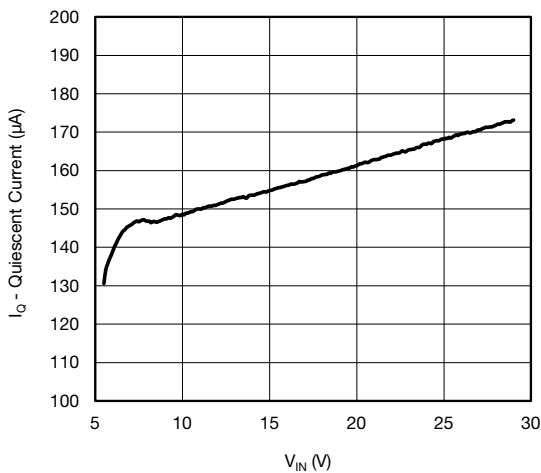

Figure 3 - Quiescent Current vs. Input Voltage

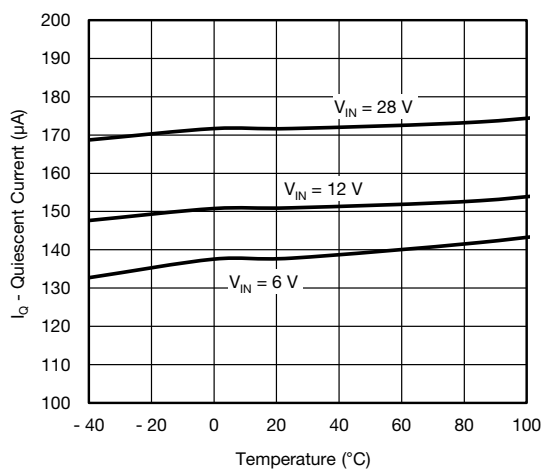

Figure 4 - Quiescent Current vs. Temperature

TYPICAL CHARACTERISTICS (internally regulated, 25 °C, unless otherwise noted)

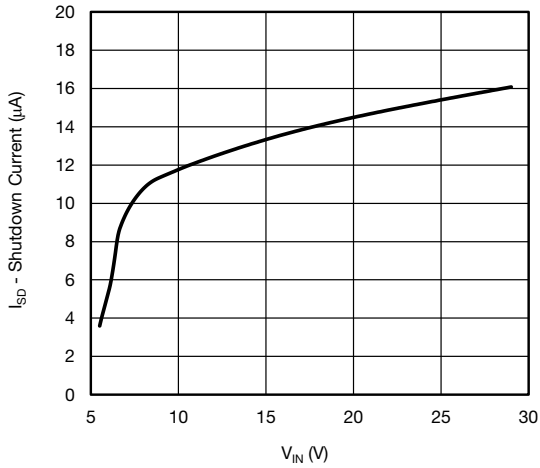

Figure 5 - Shutdown Current vs. Input Voltage

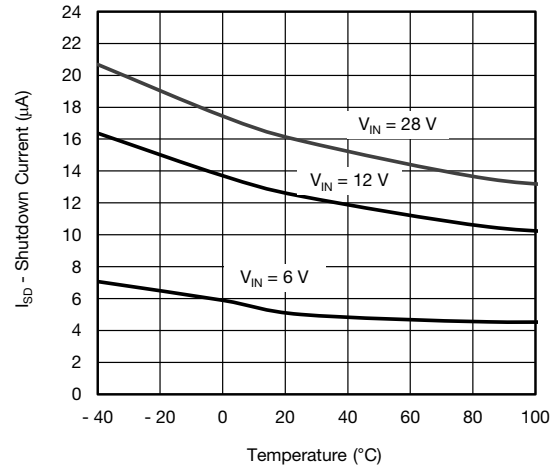

Figure 8 - Shutdown Current vs. Temperature

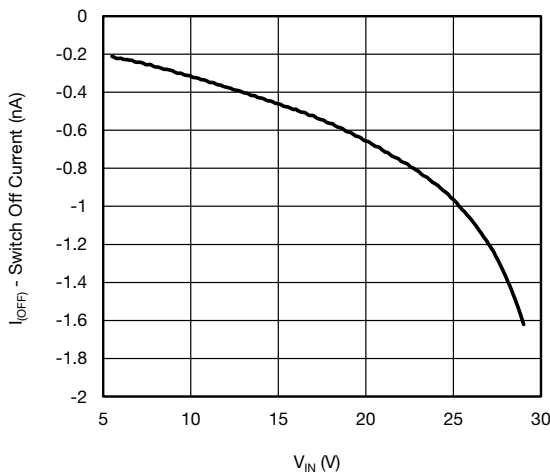

Figure 6 - Shutdown Current vs. Input Voltage

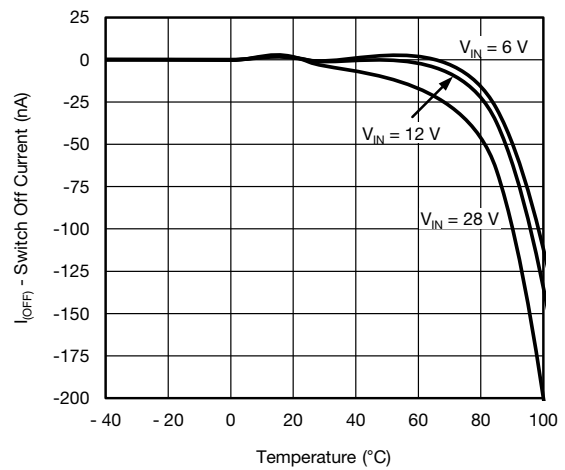

Figure 9 - Switch Off Current vs. Temperature

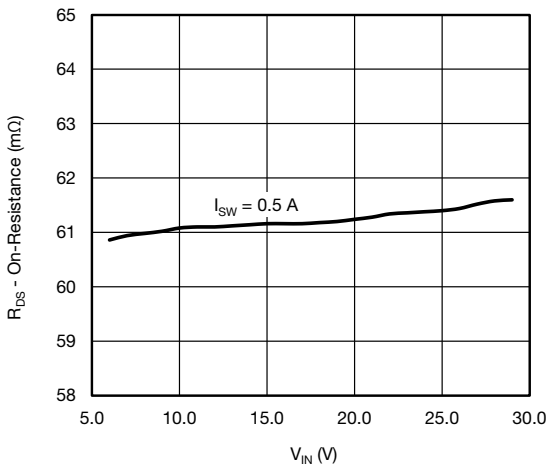

Figure 7 - On Resistance vs. Input Voltage

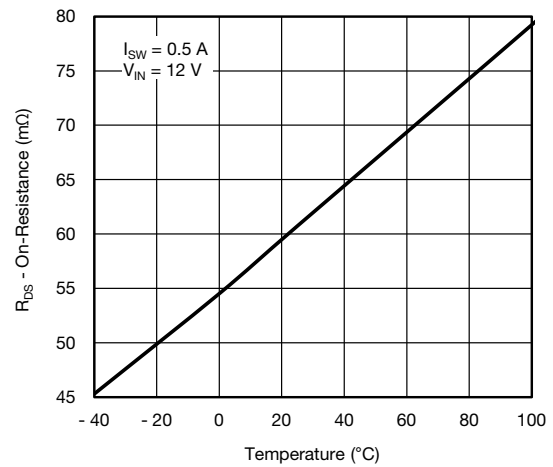

Figure 10 - On Resistance vs. Temperature

TYPICAL CHARACTERISTICS (internally regulated, 25 °C, unless otherwise noted)

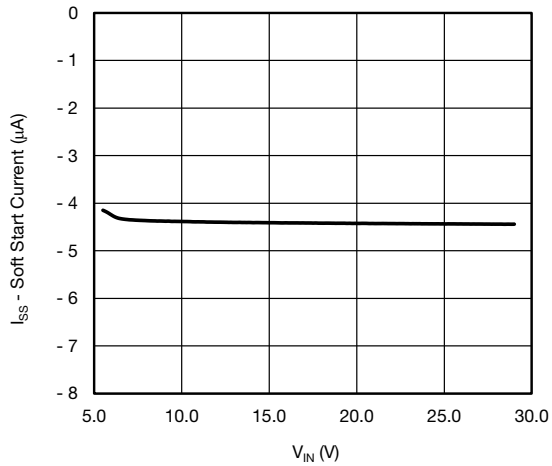

Figure 11 - Soft Start Current vs. Input Voltage

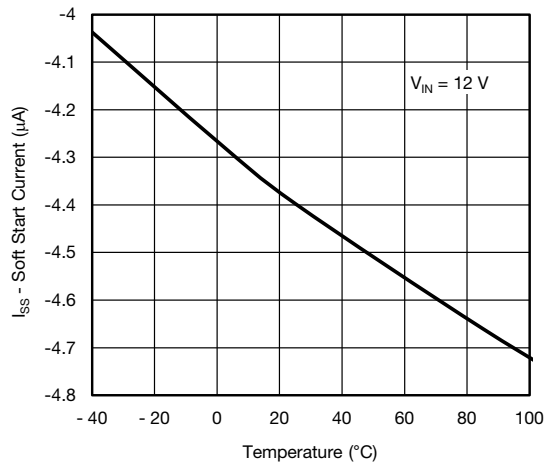

Figure 13 - Soft Start Current vs. Temperature

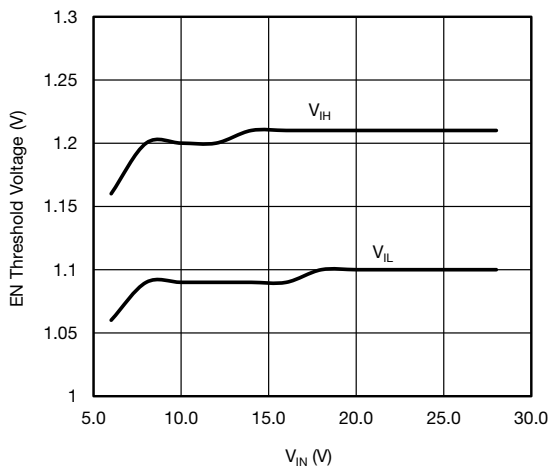

Figure 12 - Threshold Voltage vs. Input Voltage

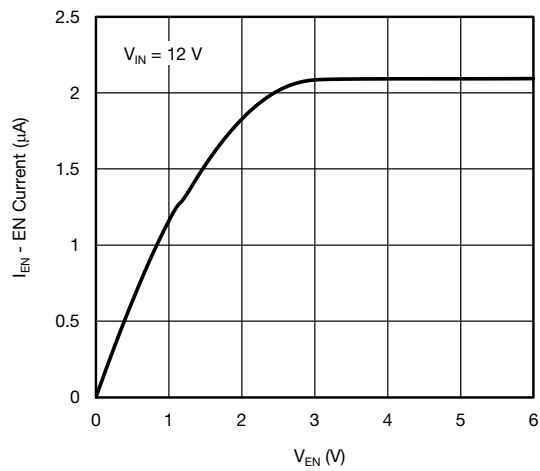

Figure 14 - EN Current vs. V_{EN}

TYPICAL CHARACTERISTICS (internally regulated, 25 °C, unless otherwise noted)

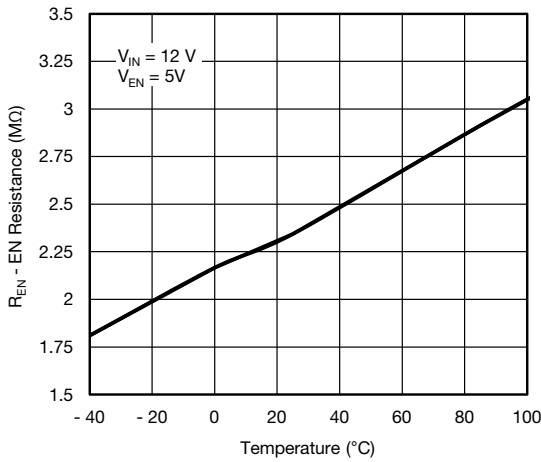

Figure 15 - EN Resistance vs. Temperature

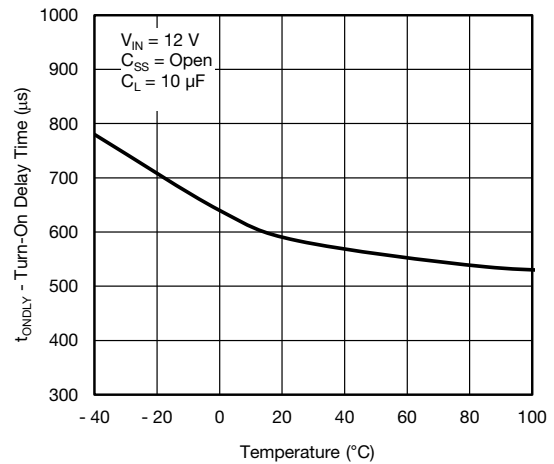

Figure 17 - Turn-On Delay Time vs. Temperature

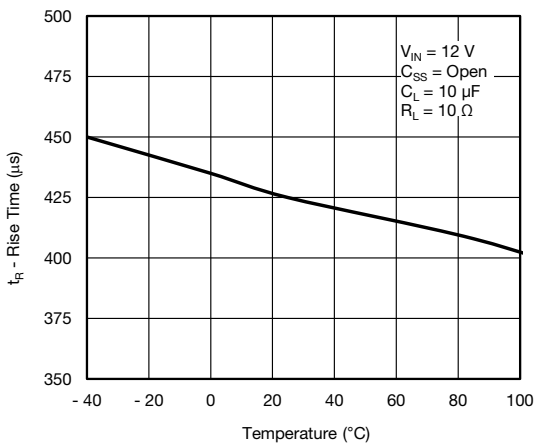

Figure 16 - Rise Time vs. Temperature

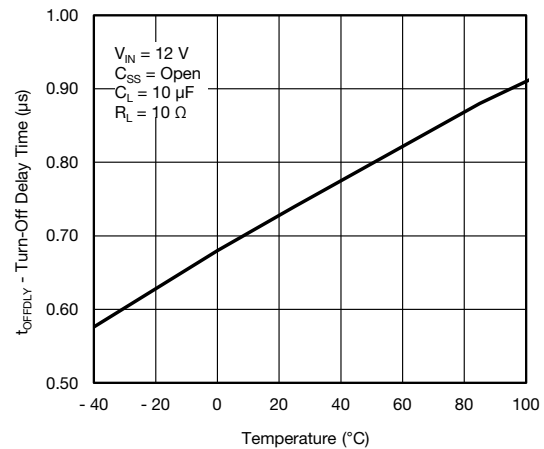

Figure 18 - Turn-Off Delay Time vs. Temperature

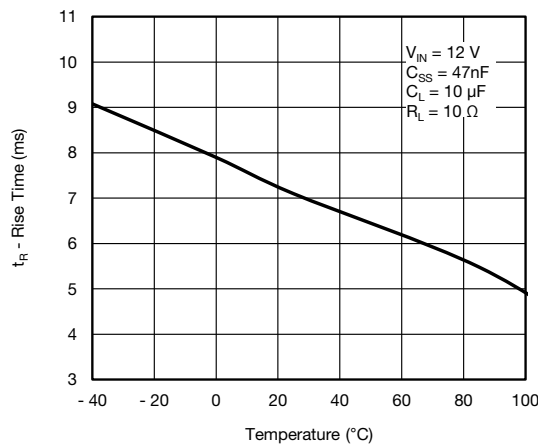

Figure 19 - Rise Time vs. Temperature

TYPICAL WAVEFORMS

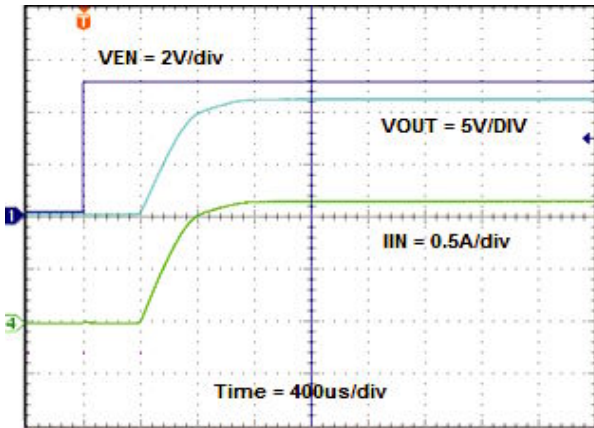

Figure 20 - Turn On Time,
 $V_{IN} = 12\text{ V}$, $C_{SS} = \text{open}$, $R_L = 10\ \Omega$, $C_L = 10\ \mu\text{F}$

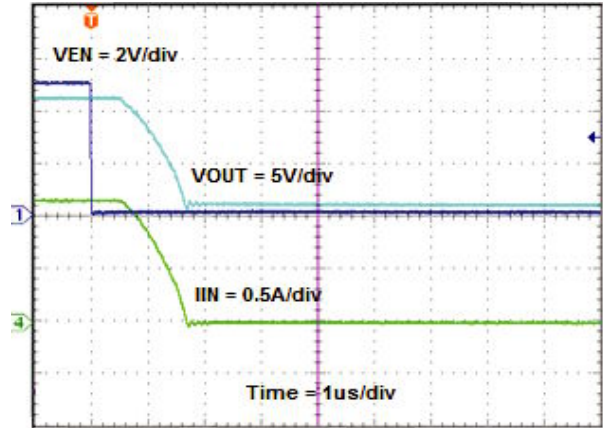

Figure 23 - Turn Off Time,
 $V_{IN} = 12\text{ V}$, $C_{SS} = \text{open}$, $R_L = 10\ \Omega$, $C_L = 10\ \mu\text{F}$

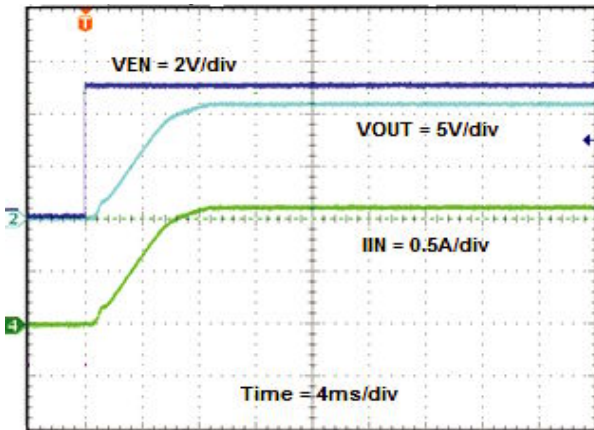

Figure 21 - Turn On Time,
 $V_{IN} = 12\text{ V}$, $C_{SS} = 47\text{ nF}$, $R_L = 10\ \Omega$, $C_L = 10\ \mu\text{F}$

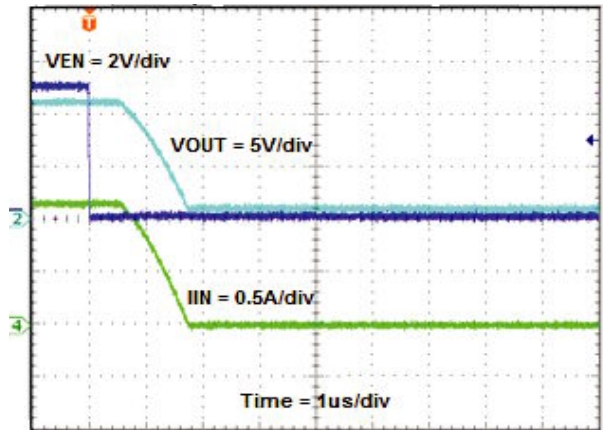

Figure 24 - Turn Off Time,
 $V_{IN} = 12\text{ V}$, $C_{SS} = 47\text{ nF}$, $R_L = 10\ \Omega$, $C_L = 10\ \mu\text{F}$

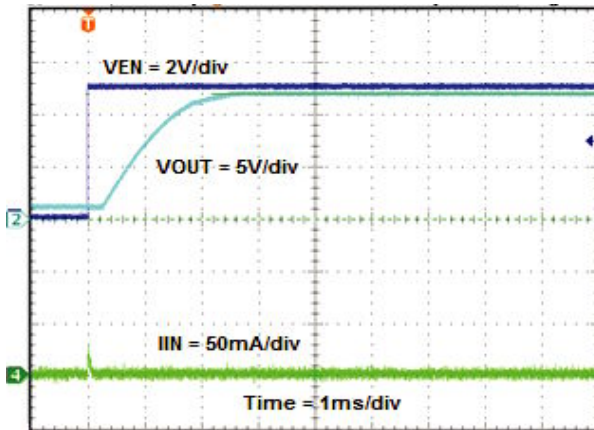

Figure 22 - Turn On Time,
 $V_{IN} = 12\text{ V}$, $C_{SS} = 47\text{ nF}$, $R_L = \text{open}$, $C_L = 10\ \mu\text{F}$

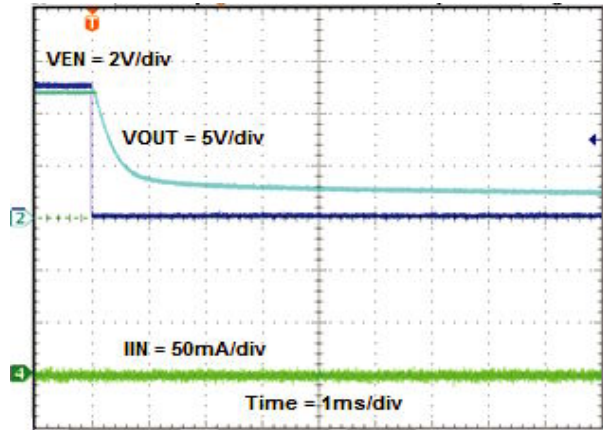

Figure 25 - Turn Off Time,
 $V_{IN} = 12\text{ V}$, $C_{SS} = 47\text{ nF}$, $R_L = \text{open}$, $C_L = 10\ \mu\text{F}$

TYPICAL WAVEFORMS

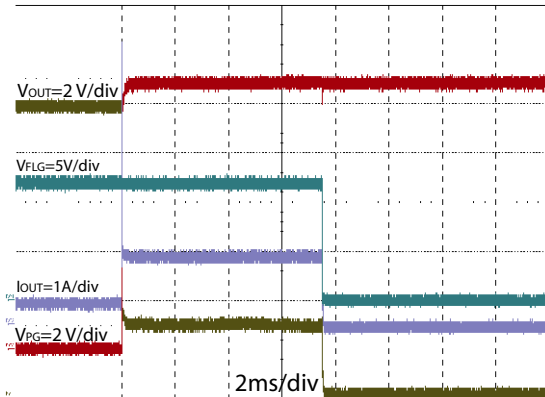

Figure 26 - Current Limit
from 25 Ω to 2 Ω Load, $V_{IN} = 12\text{ V}$

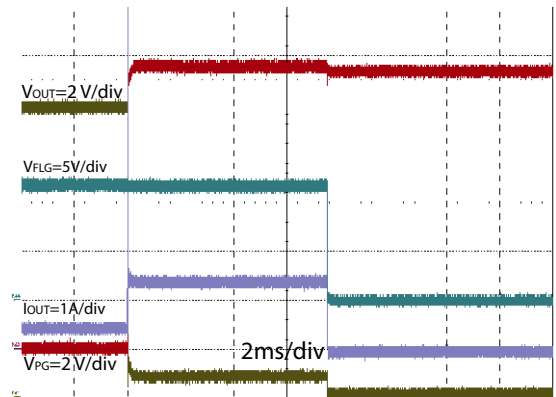

Figure 27 - Current Limit
from 25 Ω to 0.5 Ω Load, $V_{IN} = 12\text{ V}$

DETAILED DESCRIPTION

OVER CURRENT LIMIT

When an over-current event occurs, the SiP32429 will current limit immediately. If the event exceeds 7 ms the switch is turned OFF and the FLG pin is pulled low. The device remains off for 150 ms and after this time if the signal on EN pin is in a high state, the switch will enable.

The current limit is set by connecting a resistor between the I_{LIM} pin and GND. R_{SET} can be calculated by the following formula:

$$I_{lim} = \frac{1.24\text{ V}}{R_{SET}} \times 5000$$

Where:

I_{LIM} = is the target current limit setting.

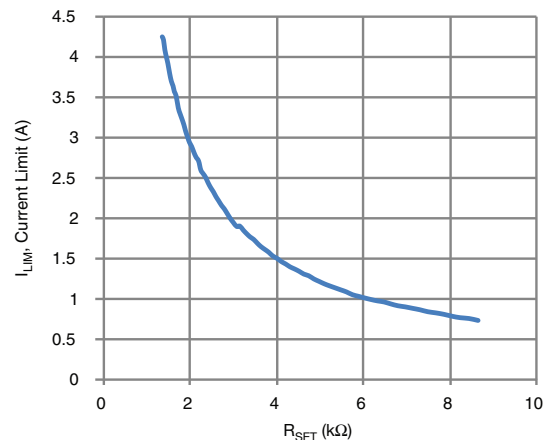

Figure 28 - Current Limit vs. R_{SET}

R_{SET} SELECTION TABLE				
R_{SET} (kΩ)	Current Limit (A)			Tol. (%)
	Min.	Typ.	Max.	
1.74	2.85	3.56	4.28	20
1.78	2.78	3.48	4.18	20
1.82	2.73	3.41	4.09	20
2.21	2.25	2.81	3.37	20
2.80	1.77	2.21	2.66	20
3.57	1.39	1.74	2.08	20
4.12	1.20	1.50	1.81	20
4.53	1.03	1.37	1.71	25
5.76	0.81	1.08	1.35	25
7.32	0.64	0.85	1.06	25
8.25	0.56	0.75	0.94	25

SOFT START

The soft start time can be calculated by the following formula:

$$\frac{\Delta V_{OUT}}{\Delta T} = \frac{I_{SS}}{C_{SS}} \times \frac{R_{OUT} \times 5000}{R_{SET}}$$

Where:

ΔT is the soft start time

ΔV_{OUT} is the output voltage range

I_{SS} is the built-in current source charging the soft start capacitor C_{SS} . I_{SS} value is 5 μA typical.

C_{SS} is the soft start time setting capacitor.

R_{SET} is the current limit setting resistor.

R_{OUT} is the output load.

ENABLE

The enable pin needs to be high for the device to become active. This can be accomplished by applying a logic high signal to the EN pin. Alternatively this pin can be hardwired through a resistor divider to the V_{IN} , thus keeping the switch permanently ON as long as the supply is present.

FLG

The FLG is an open drain output and will be pulled low in fault condition. This pin can be pulled up through a 100K resistor.

PG

The PG is an open drain output that will be pulled low when output voltage passes 90 % of the V_{IN} . This pin can be pulled up through a 100K resistor.

APPLICATION INFORMATION

INPUT CAPACITOR

While bypass capacitors at the inputs pins are not required, a 2.2 μF or larger capacitors for C_{IN} is recommended in almost all applications. The bypass capacitors should be placed as physically close to the device's input pins to be effective to minimize transients on the input. Ceramic capacitors are recommended over tantalum because of their ability to withstand input current surges from low impedance sources such as batteries.

OUTPUT CAPACITOR

The device does not require an output capacitor for proper operation. A proper value C_{OUT} is recommended to accommodate load transient per circuit design requirements. There are no ESR or capacitor type requirements.

OVER TEMPERATURE SHUTDOWN

In case an over temperature event happens, the SiP32429 will turn the switch off immediately. It will then retry to start 150 ms after the temperature is back to normal; during this period, FLG will be pulled low. The SiP32429 FLG will be pulled high 150 ms after the OT event has finished.

THERMAL CONSIDERATION

The SiP32429 is designed to maintain a constant output load current. Due to physical limitations of the layout and assembly of the device the maximum switch current should be kept at reasonably safe level. However, another limiting characteristic of the safe operating load current is the thermal power dissipation.

SOA

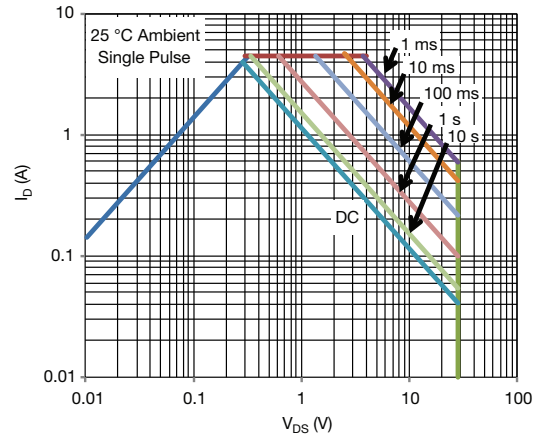

Figure 29 - SOA on Application Board

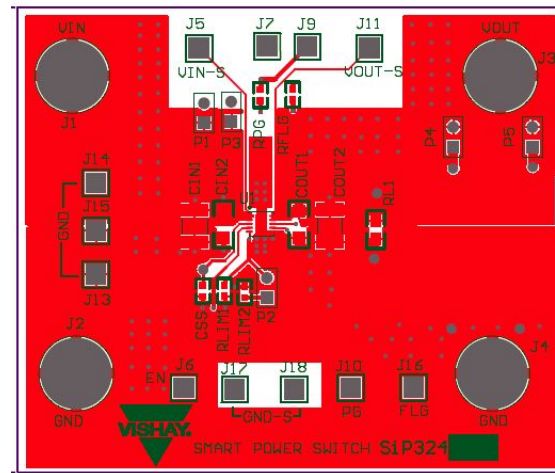

Figure 30 - Application Board Layout

Vishay Siliconix maintains worldwide manufacturing capability. Products may be manufactured at one of several qualified locations. Reliability data for Silicon Technology and Package Reliability represent a composite of all qualified locations. For related documents such as package/tape drawings, part marking, and reliability data, see www.vishay.com/ppq?63939.



Disclaimer

ALL PRODUCT, PRODUCT SPECIFICATIONS AND DATA ARE SUBJECT TO CHANGE WITHOUT NOTICE TO IMPROVE RELIABILITY, FUNCTION OR DESIGN OR OTHERWISE.

Vishay Intertechnology, Inc., its affiliates, agents, and employees, and all persons acting on its or their behalf (collectively, "Vishay"), disclaim any and all liability for any errors, inaccuracies or incompleteness contained in any datasheet or in any other disclosure relating to any product.

Vishay makes no warranty, representation or guarantee regarding the suitability of the products for any particular purpose or the continuing production of any product. To the maximum extent permitted by applicable law, Vishay disclaims (i) any and all liability arising out of the application or use of any product, (ii) any and all liability, including without limitation special, consequential or incidental damages, and (iii) any and all implied warranties, including warranties of fitness for particular purpose, non-infringement and merchantability.

Statements regarding the suitability of products for certain types of applications are based on Vishay's knowledge of typical requirements that are often placed on Vishay products in generic applications. Such statements are not binding statements about the suitability of products for a particular application. It is the customer's responsibility to validate that a particular product with the properties described in the product specification is suitable for use in a particular application. Parameters provided in datasheets and/or specifications may vary in different applications and performance may vary over time. All operating parameters, including typical parameters, must be validated for each customer application by the customer's technical experts. Product specifications do not expand or otherwise modify Vishay's terms and conditions of purchase, including but not limited to the warranty expressed therein.

Except as expressly indicated in writing, Vishay products are not designed for use in medical, life-saving, or life-sustaining applications or for any other application in which the failure of the Vishay product could result in personal injury or death. Customers using or selling Vishay products not expressly indicated for use in such applications do so at their own risk. Please contact authorized Vishay personnel to obtain written terms and conditions regarding products designed for such applications.

No license, express or implied, by estoppel or otherwise, to any intellectual property rights is granted by this document or by any conduct of Vishay. Product names and markings noted herein may be trademarks of their respective owners.

Material Category Policy

Vishay Intertechnology, Inc. hereby certifies that all its products that are identified as RoHS-Compliant fulfill the definitions and restrictions defined under Directive 2011/65/EU of The European Parliament and of the Council of June 8, 2011 on the restriction of the use of certain hazardous substances in electrical and electronic equipment (EEE) - recast, unless otherwise specified as non-compliant.

Please note that some Vishay documentation may still make reference to RoHS Directive 2002/95/EC. We confirm that all the products identified as being compliant to Directive 2002/95/EC conform to Directive 2011/65/EU.

Vishay Intertechnology, Inc. hereby certifies that all its products that are identified as Halogen-Free follow Halogen-Free requirements as per JEDEC JS709A standards. Please note that some Vishay documentation may still make reference to the IEC 61249-2-21 definition. We confirm that all the products identified as being compliant to IEC 61249-2-21 conform to JEDEC JS709A standards.