

# Approval Sheet

## (產品承認書)

產品名稱 (Product): BT 5.0 Module (nRF52840)

產品型號 (Model No.): MDBT50Q – 1M (Chip Antenna)

MDBT50Q – P1M (PCB Antenna)

*Working distance of MDBT50Q-1M & MDBT50Q-P1M:*

- **1Mbps:**  
MDBT50Q: over 300 meters in open space.  
MDBT50Q-P: up to 250 meters in open space.
- **2Mbps:**  
MDBT50Q: over 150 meters in open space.  
MDBT50Q-P: up to 120 meters in open space.

# Index

<b>1. Overall Introduction .....</b>	<b>3</b>
1.1. Application .....	3
1.2. Features .....	4
<b>2. Product Dimension .....</b>	<b>6</b>
2.1. PCB Dimensions & Pin Indication.....	6
2.2. Recommended Layout of Solder Pad.....	8
2.3. RF Layout Suggestion (aka Keep-Out Area) .....	12
2.4. Pin Assignment.....	15
2.5. GPIO Located Near the Radio.....	18
<b>3. Main Chip Solution.....</b>	<b>18</b>
<b>4. Shipment Packaging Information .....</b>	<b>19</b>
<b>5. Specification .....</b>	<b>20</b>
5.1. Absolute Maximum Ratings .....	20
5.2. Operating Conditions.....	20
5.3. Electrical Specifications.....	21
<b>6. Block Diagram .....</b>	<b>27</b>
<b>7. Antenna .....</b>	<b>28</b>
7.1. MDBT50Q Series .....	28
7.2. MDBT50Q-P Series.....	30
<b>8. Reference Circuit.....</b>	<b>32</b>
<b>9. Certification .....</b>	<b>33</b>
<b>10. Notes and Cautions.....</b>	<b>33</b>
<b>11. Basic Facts for nRF52 Chip.....</b>	<b>34</b>
<b>12. Useful Links .....</b>	<b>35</b>
<b>Full List of Raytac's BLE Modules .....</b>	<b>36</b>
<b>Release Note.....</b>	<b>38</b>

# 1. Overall Introduction

Raytac's MDBT50Q & MDBT50Q-P is a BT 5.0 stack (Bluetooth low energy or BLE) module designed based on **Nordic nRF52840 SoC solution**, which incorporates: **GPIO, SPI, UART, I2C, I2S, PMD, PWM, ADC, NFC** and **USB** interfaces for connecting peripherals and sensors.

Features of the module:

1. Embedded 2.4GHz transceiver supports Bluetooth 5, IEEE 802.15.4 & 2.4Ghz RF & ANT upon customer's preference.
2. Compact size with **(L) 15.5 x (W) 10.5 x (H) 2.2 or 2.0 mm**.
3. Low power requirements, ultra-low peak, average and idle mode power consumption.
4. Be compatible with a large installed base of mobile phones, tablets and computers.
5. Fully coverage of BLE software stack.
6. BLE & RF transmission switching helps products fit all operation system and most hardware.

## 1.1. Application

- IoT Networks
  - Smart home (such as door locks, lighting) sensors and controllers
  - Smart city sensor networks
  - Industrial IoT sensors and controllers
  - Connected white goods
- Personal Area Networks
  - Health / fitness sensor and monitor device
  - Medical device
- Interactive entertainment devices
  - Advanced remote controls
  - Gaming controller
- Advanced wearables
  - Connected watches
  - Advanced personal fitness devices
  - Wearables with wireless secure payment
  - Connected Health
  - Virtual/Augmented Reality applications
- High performance HID Controllers

## 1.2. Features

- Bluetooth 5, IEEE 802.15.4, 2.4 GHz transceiver
  - -95dBm sensitivity in 1Mbps Bluetooth low energy (BLE) mode
  - -103dBm sensitivity in 125Kbps BLE mode (long range)
  - +8 dBm TX power (down to -20 dBm in 4 dB steps)
  - On-air compatible with nRF52, nRF51, nRF24L and nRF24AP Series
  - Programmable output power from +8dBm to -20dB
  - RSSI (1dB resolution)
  - Supported data rates:
    - Bluetooth 5: 2 Mbps, 1 Mbps, 500 kbps, 125 kbps
    - IEEE 802.15.4-2006: 250 kbps
    - Proprietary 2.4 GHz: 2 Mbps, 1 Mbps
- ARM Cortex –M4 32-bit processor with FPU, 64 MHz
- Memory: 1MB flash / 256KB RAM
- HW accelerated security
  - ARM TrustZone Cryptocell 310 cryptographic accelerator
  - 128 bit AES / ECB / CCM / AAR co-processor (on-the-fly packet encryption)
- Advanced on-chip interfaces
  - USB 2.0 full speed (12Mbps) controller
  - QSPI 32MHz interface
  - High speed 32MHz SPI
  - Type 2 near field communication (NFC-A) tag with wake-on field
  - Programmable peripheral interconnect (PPI)
  - 48 general purpose I/O pins
  - EasyDMA automated data transfer without CPU processing on peripherals
- 12 bit, 200ksps ADC – 8 configurable channels with programmable gain
- 4 x 4 channel pulse width modulator (PWM)units with EasyDMA
- Audio peripherals : I2S, digital microphone interface (PDM)
- 5 X 32-bit timers with counter mode
- Up to 4 x SPI masters / 3 x SPI slaves with EasyDMA
- Up to 2 x I2C compatible 2-wire masters / slaves
- 2 x UART(CTS/RTS) with EasyDMA
- Quadrature decoder (QDEC)
- 3 x 24-bit real-time counters (RTC)

- Flexible power management
  - Supply voltage range 1.7V to 5.5V
  - On-chip DC/DC and LDO regulators with automated low current modes
  - Regulated supply for external components from 1.8V to 3.3V
  - Automated peripheral power management
  - Fast wake-up using 64MHz internal oscillator
  - 0.4uA at 3V in OFF mode, no RAM retention
  - 1.5uA at 3V in ON mode, no RAM retention, wake on RTC
- Nordic SoftDevice ready and with support for concurrent multi-protocol



## 2. Product Dimension

### 2.1. PCB Dimensions & Pin Indication

- **MDBT50Q**

**PCB SIZE: (L) 15.5 x (W) 10.5x (H) 2.2 mm**

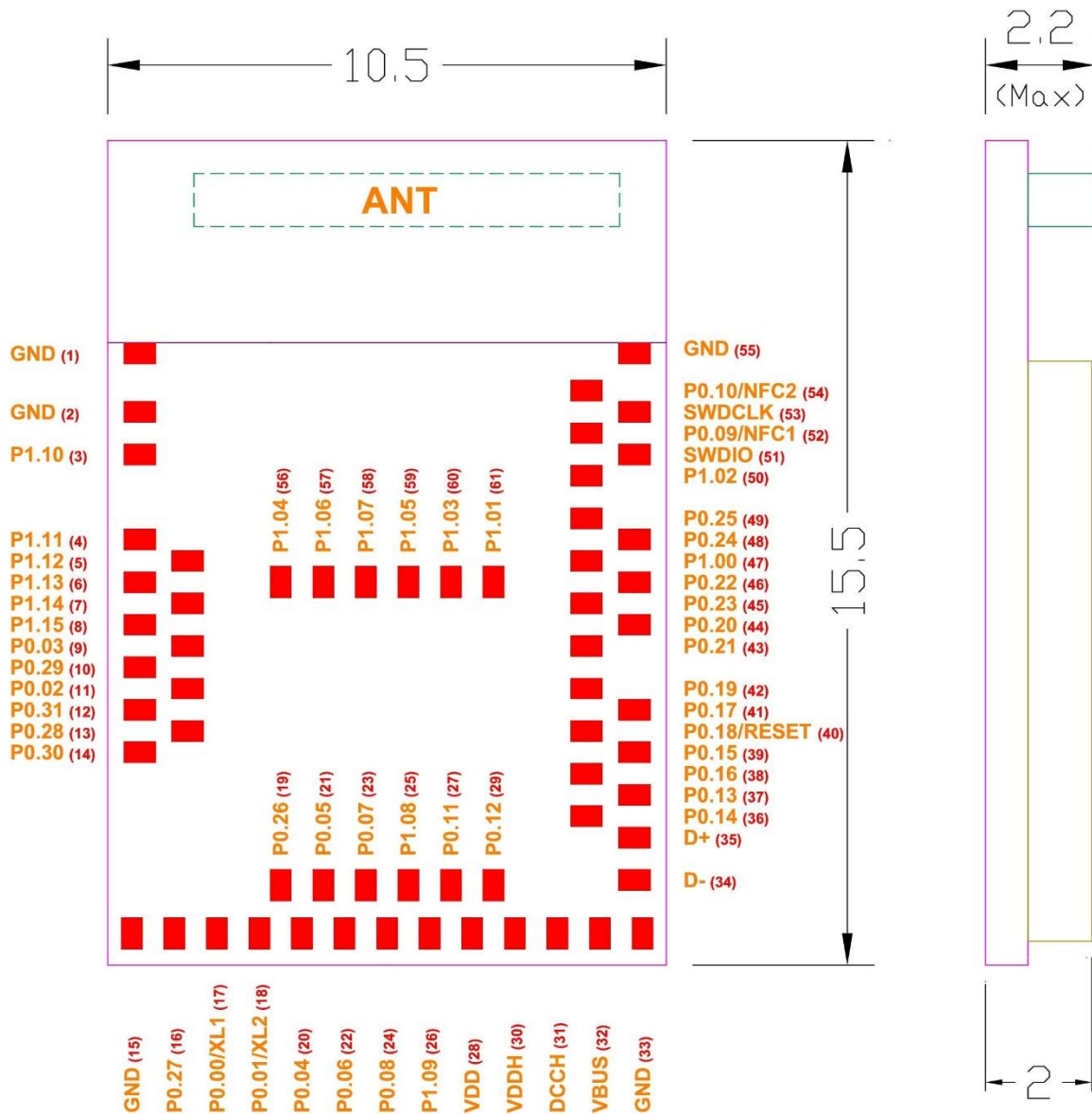

Top 單位:(mm)

• **MDBT50Q-P**

**PCB SIZE: (L) 15.5 x (W) 10.5 x (H) 2.0 mm**

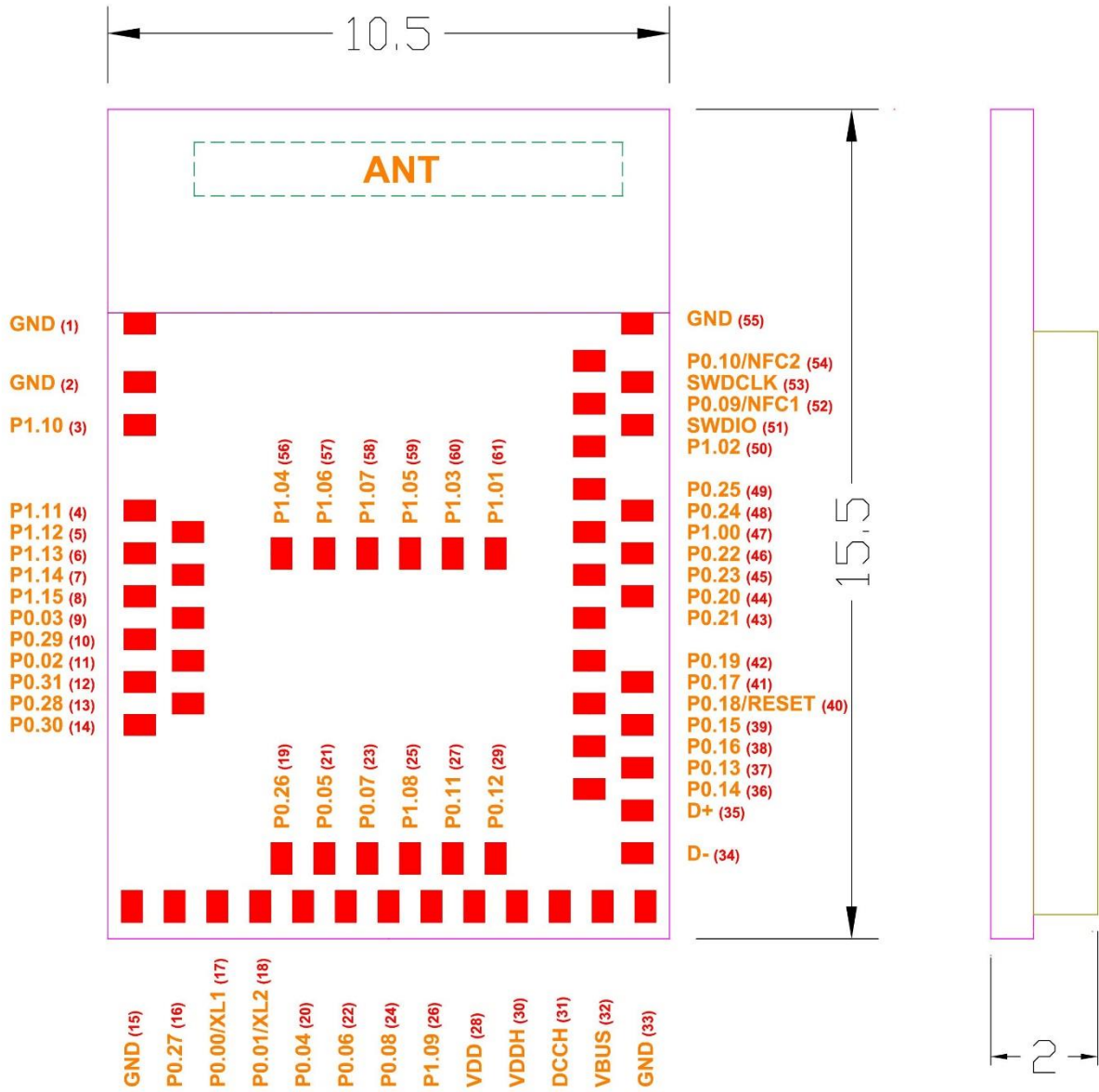

Top 單位:(mm)

## 2.2. Recommended Layout of Solder Pad

*Graphs are all in Top View, Unit in mm.*

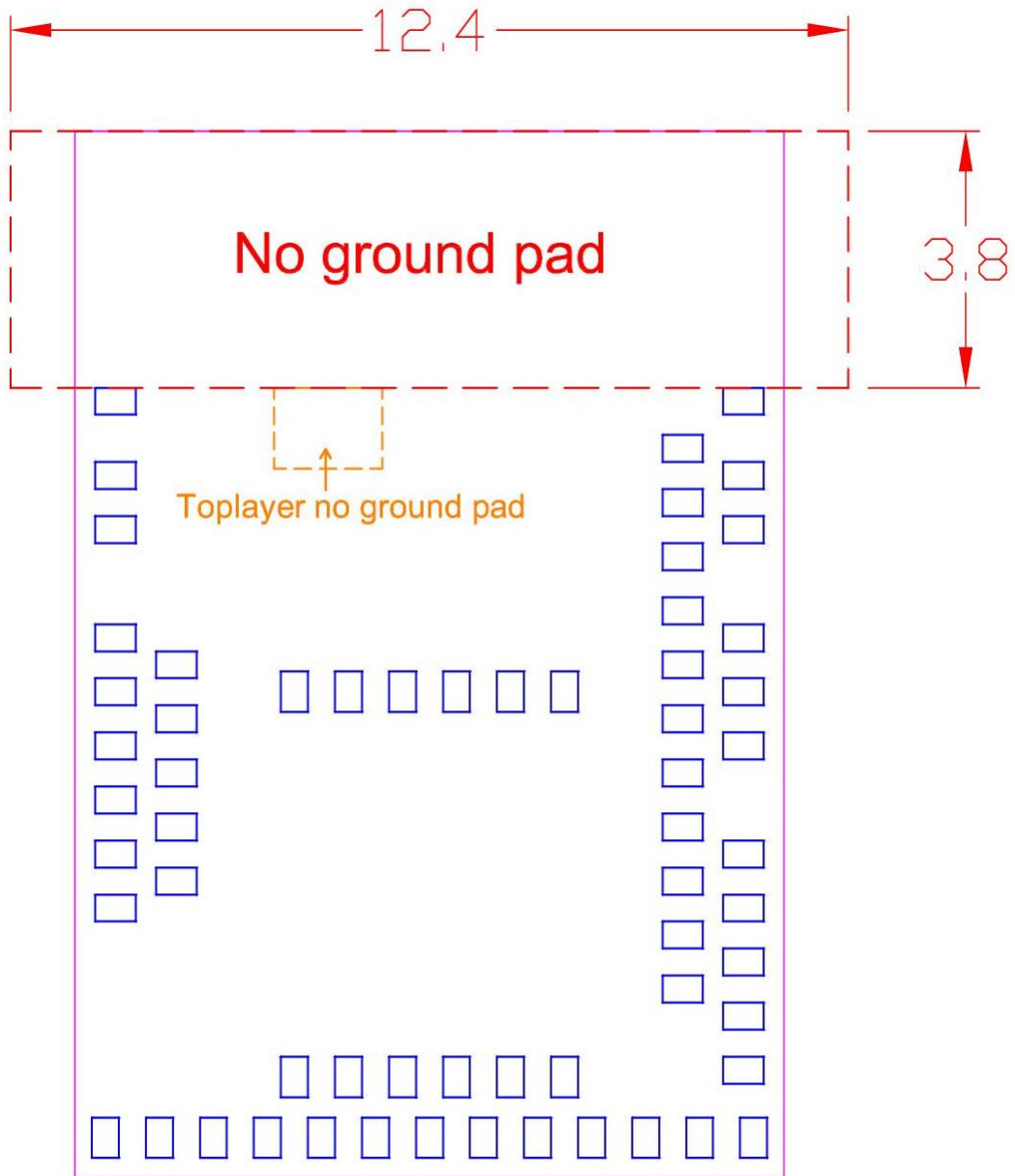

No ground pad



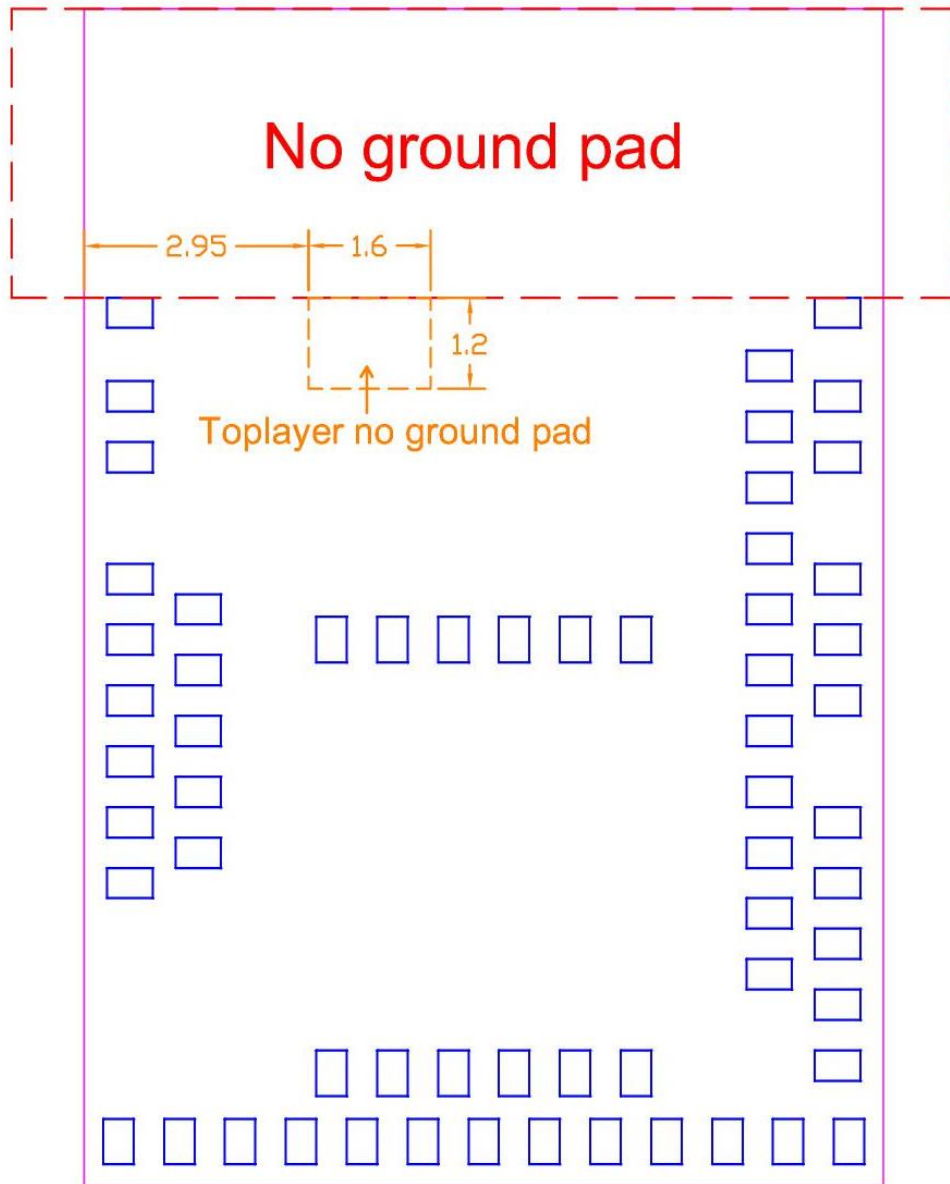

Toplayer no ground pad

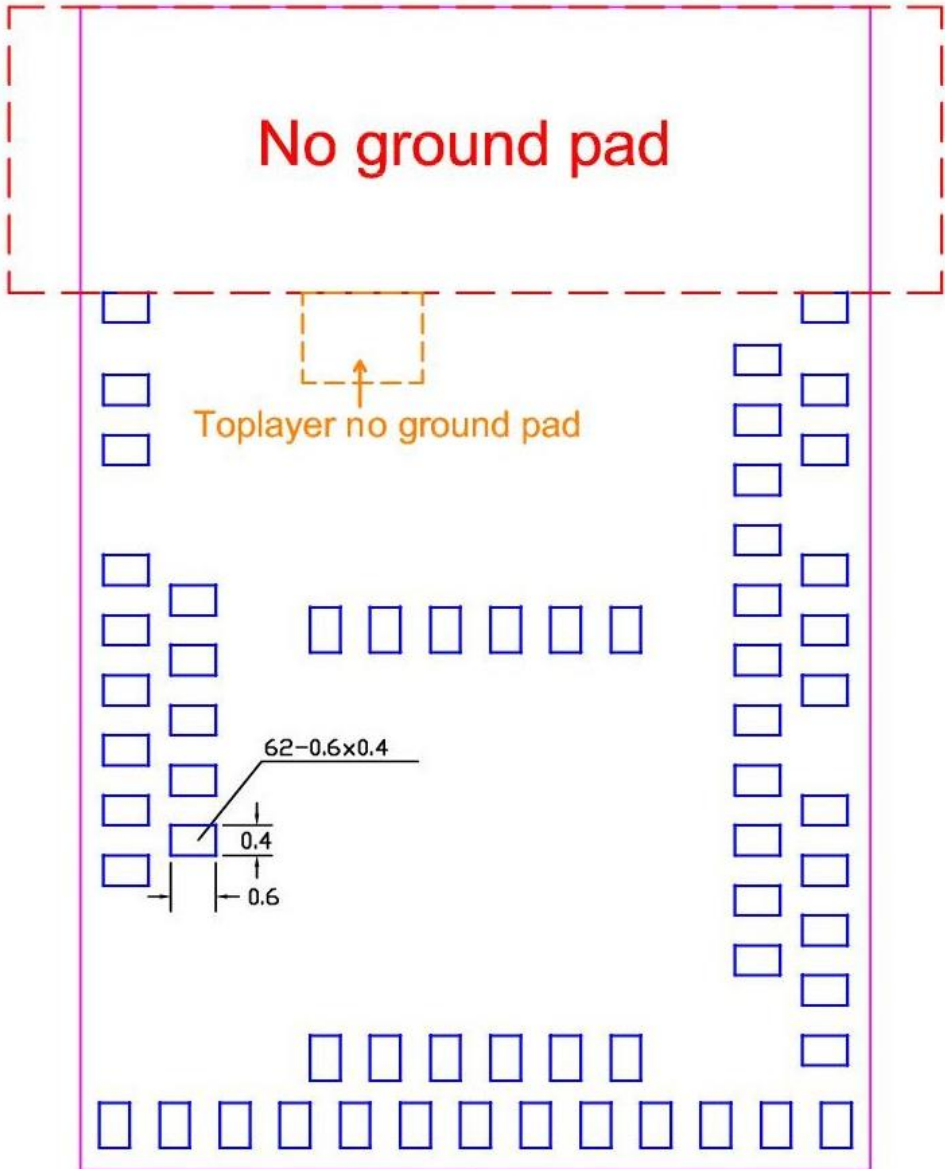

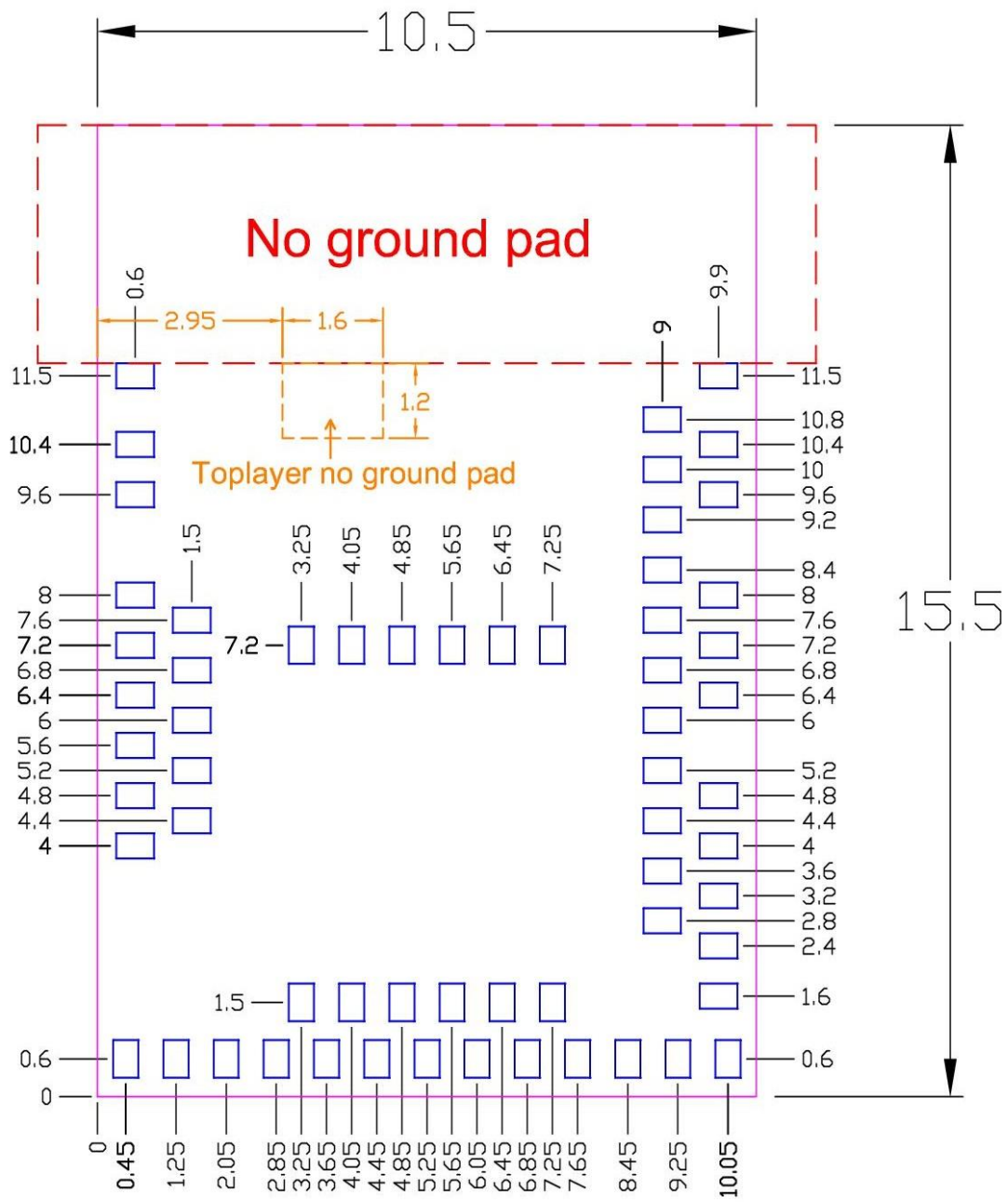

Top View (單位 : mm)  
recommended solder pad layout

### 2.3. RF Layout Suggestion (aka Keep-Out Area)

Please follow below instruction to have better wireless performance. Make sure to keep the “No-Ground-Pad” as wider as you can when there is no enough space in your design.

Welcome to send us your layout in PDF for review at [service@raytac.com](mailto:service@raytac.com) with title “Layout reviewing – MDBT50Q/MDBT50Q-P – YOUR company’s name”.

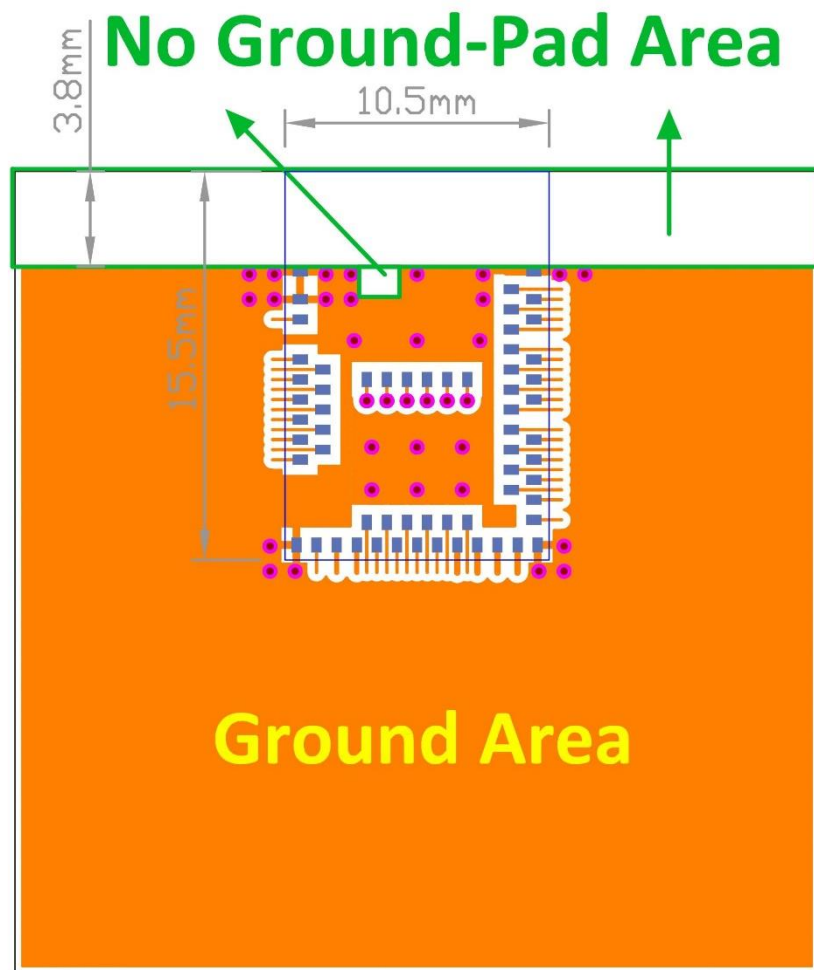

**Top layer**

Please add via holes in GROUND area as many as possible, especially around the four corners.

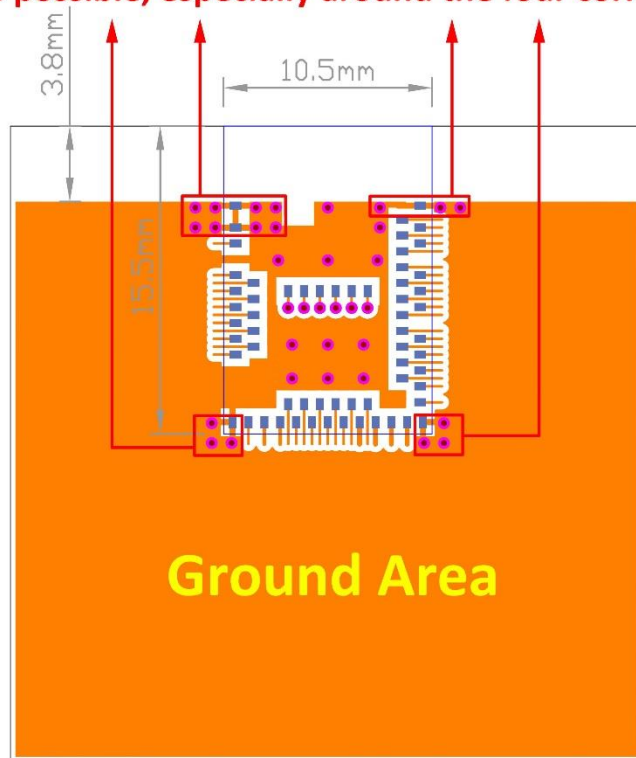

Top layer

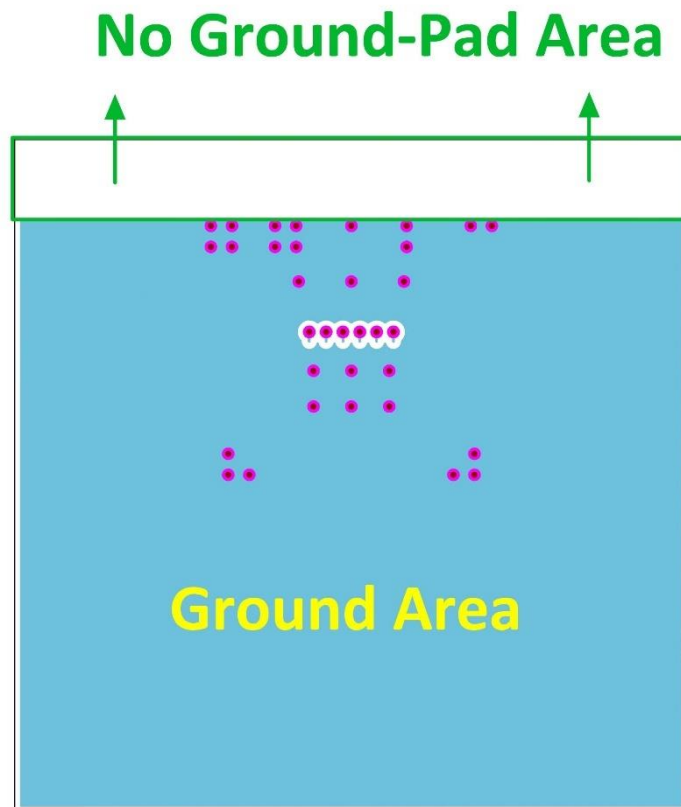

Bottom layer

Examples of “**NOT RECOMMENDED**” layout

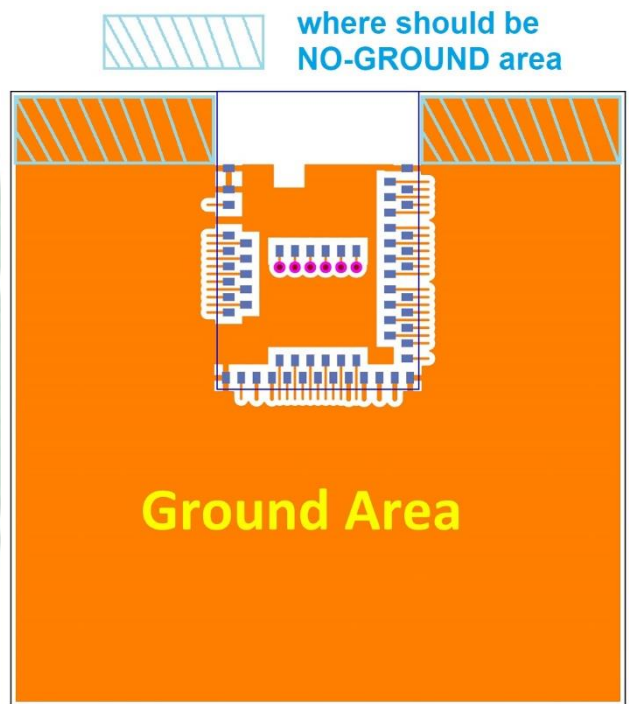
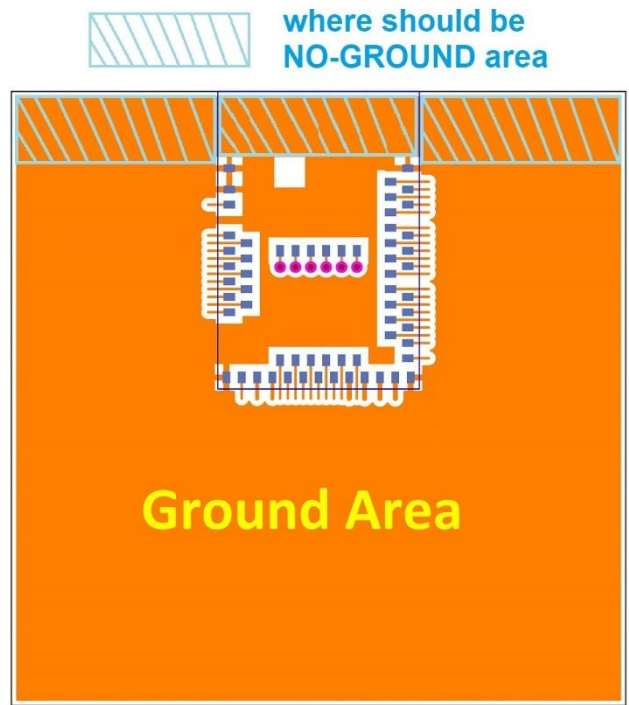

## 2.4. Pin Assignment

Pin No.	Name	Pin Function	Description
(1)	GND	Power	Ground
(2)	GND	Power	Ground
(3)	P1.10	Digital I/O	General-purpose I/O (standard drive, low frequency I/O only)
(4)	P1.11	Digital I/O	General-purpose I/O (standard drive, low frequency I/O only)
(5)	P1.12	Digital I/O	General-purpose I/O (standard drive, low frequency I/O only)
(6)	P1.13	Digital I/O	General-purpose I/O (standard drive, low frequency I/O only)
(7)	P1.14	Digital I/O	General-purpose I/O (standard drive, low frequency I/O only)
(8)	P1.15	Digital I/O	General-purpose I/O (standard drive, low frequency I/O only)
(9)	P0.03	Digital I/O	General-purpose I/O (standard drive, low frequency I/O only)
	AIN1	Analog input	Analog input
(10)	P0.29	Digital I/O	General-purpose I/O (standard drive, low frequency I/O only)
	AIN5	Analog input	Analog input
(11)	P0.02	Digital I/O	General-purpose I/O (standard drive, low frequency I/O only)
	AIN0	Analog input	Analog input
(12)	P0.31	Digital I/O	General-purpose I/O (standard drive, low frequency I/O only)
	AIN7	Analog input	Analog input
(13)	P0.28	Digital I/O	General-purpose I/O (standard drive, low frequency I/O only)
	AIN4	Analog input	Analog input

Pin No.	Name	Pin Function	Description
(14)	P0.30	Digital I/O	General-purpose I/O (standard drive, low frequency I/O only)
	AIN6	Analog input	Analog input
(15)	GND	Power	Ground
(16)	P0.27	Digital I/O	General-purpose I/O
(17)	P0.00	Digital I/O	General-purpose I/O
	XL1	Analog input	Connection for 32.768 kHz crystal
(18)	P0.01	Digital I/O	General-purpose I/O
	XL2	Analog input	Connection for 32.768 kHz crystal
(19)	P0.26	Digital I/O	General-purpose I/O
(20)	P0.04	Digital I/O	General-purpose I/O
	AIN2	Analog input	Analog input
(21)	P0.05	Digital I/O	General-purpose I/O
	AIN3	Analog input	Analog input
(22)	P0.06	Digital I/O	General-purpose I/O
(23)	P0.07	Digital I/O	General-purpose I/O
	TRACECLK	Trace clock	Trace buffer clock
(24)	P0.08	Digital I/O	General-purpose I/O
(25)	P1.08	Digital I/O	General-purpose I/O
(26)	P1.09	Digital I/O	General-purpose I/O
	TRACEDATA3	Trace data	Trace buffer TRACEDATA [3].
(27)	P0.11	Digital I/O	General-purpose I/O
	TRACEDATA2	Trace data	Trace buffer TRACEDATA[2].
(28)	VDD	Power	Power supply
(29)	P0.12	Digital I/O	General-purpose I/O
	TRACEDATA1	Trace data	Trace buffer TRACEDATA [1].
(30)	VDDH	Power	High voltage power supply
(31)	DCCH	Power	DC/DC converter output
(32)	VBUS	Power	5V input for USB 3.3V regulator



Pin No.	Name	Pin Function	Description
(33)	GND	Power	Ground
(34)	D-	Digital I/O	USB D-
(35)	D+	Digital I/O	USB D+
(36)	P0.14	Digital I/O	General-purpose digital I/O
(37)	P0.13	Digital I/O	General-purpose digital I/O
(38)	P0.16	Digital I/O	General-purpose digital I/O
(39)	P0.15	Digital I/O	General-purpose digital I/O
(40)	P0.18	Digital I/O	General-purpose digital I/O (recommended usage: QSPI / CSN)
	nRESET		Configurable as system RESET
(41)	P0.17	Digital I/O	General-purpose digital I/O
(42)	P0.19	Digital I/O	General-purpose digital I/O (recommended usage: (QSPI / SCK)
(43)	P0.21	Digital I/O	General-purpose digital I/O (recommended usage: QSPI)
(44)	P0.20	Digital I/O	General-purpose digital I/O
(45)	P0.23	Digital I/O	General-purpose digital I/O (recommended usage: QSPI)
(46)	P0.22	Digital I/O	General-purpose digital I/O (recommended usage: QSPI)
(47)	P1.00	Digital I/O	General-purpose digital I/O (recommended usage: QSPI)
	TRACEDATA0	Trace data	Trace buffer TRACEDATA [0].
(48)	P0.24	Digital I/O	General-purpose digital I/O
(49)	P0.25	Digital I/O	General-purpose digital I/O
(50)	P1.02	Digital I/O	General-purpose I/O (standard drive, low frequency I/O only)
(51)	SWDIO	Debug	Debug serial data
(52)	P0.09	Digital I/O	General-purpose I/O (standard drive, low frequency I/O only)
	NFC1	NFC input	NFC antenna connection
(53)	SWDCLK	Debug	Serial wire debug clock input for debug and programming

Pin No.	Name	Pin function	Description
(54)	P0.10	Digital I/O	General-purpose I/O (standard drive, low frequency I/O only)
	NFC2	NFC input	NFC antenna connection
(55)	GND	Power	Ground
(56)	P1.04	Digital I/O	General-purpose I/O (standard drive, low frequency I/O only)
(57)	P1.06	Digital I/O	General-purpose I/O (standard drive, low frequency I/O only)
(58)	P1.07	Digital I/O	General-purpose I/O (standard drive, low frequency I/O only)
(59)	P1.05	Digital I/O	General-purpose I/O (standard drive, low frequency I/O only)
(60)	P1.03	Digital I/O	General-purpose I/O (standard drive, low frequency I/O only)
(61)	P1.01	Digital I/O	General-purpose I/O (standard drive, low frequency I/O only)

## 2.5. GPIO Located Near the Radio



Please refer to [2.4 Pin Assignment](#) on page 16 to 18 where identifies some GPIO that have recommended usage. To maximize RF performance, these GPIO are only available to use under standard drive, low frequency I/O only, wrong usage may lead to undesirable performance.

## 3. Main Chip Solution

RF IC	Crystal Frequency
Nordic NRF52840	32MHZ

*32MHz crystal and RF (VDD) DC/DC inductor are already inside the module.*

## 4. Shipment Packaging Information

Antenna	Model
Chip/Ceramic Antenna	MDBT50Q-1M
	
PCB/Printed Antenna	MDBT50Q-P1M
	

- Unit Weight of Module:

MDBT50Q-1M: 0.68g / pc ( $\pm 0.02g$ ) ; MDBT50Q-P1M: 0.64g / pc ( $\pm 0.02g$ )

- Packaging Type: Tray only

- Minimum Package Quantity (MPQ): 88 pcs per Tray

- Carton Contents: 1760 pcs per carton (20 Full Tray + 1 Empty Tray)

- Dimension of Carton: (L) 37 x (W) 21 x (H) 13 cm

- Gross Weight: approx. 2.80 kgs per full carton (contains 1760pcs)

# 5. Specification

Any technical spec shall refer to Nordic's official documents as final reference.

## 5.1. Absolute Maximum Ratings

	Note	Min.	Max.	Unit
<b>Supply voltages</b>				
VDD		-0.3	+3.9	V
VDDH		-0.3	+5.8	V
VBUS		-0.3	+5.8	V
VSS			0	V
<b>I/O pin voltage</b>				
$V_{I/O}$ , VDD $\leq$ 3.6 V		-0.3	VDD + 0.3 V	V
$V_{I/O}$ , VDD $>$ 3.6 V		-0.3	3.9 V	V
<b>NFC antenna pin current</b>				
$I_{NFC1/2}$			80	mA
<b>Radio</b>				
RF input level			10	dBm
<b>Environmental (aQFN™ package)</b>				
Storage temperature		-40	+125	°C
MSL	Moisture Sensitivity Level		2	
ESD HBM	Human Body Model		2	kV
ESD CDM <sub>QF</sub>	Charged Device Model (aQFN™ 73, 7x7 mm package)		750	V
<b>Flash memory</b>				
Endurance		10 000		Write/erase cycles
Retention		10 years at 40°C		

## 5.2. Operating Conditions

Symbol	Parameter	Min.	Nom.	Max.	Units
VDD	VDD supply voltage, independent of DCDC enable	1.7	3.0	3.6	V
VDD <sub>POR</sub>	VDD supply voltage needed during power-on reset	1.75			V
VDDH	VDDH supply voltage, independent of DCDC enable	2.5	3.7	5.5	V
VBUS	VBUS USB supply voltage	4.35	5	5.5	V
$t_{R\_VDD}$	Supply rise time (0 V to 1.7 V)			60	ms
$t_{R\_VDDH}$	Supply rise time (0 V to 3.7 V)			100	ms
TA	Operating temperature	-40	25	85	°C

\*\*\* The on-chip power-on reset circuitry may not function properly for rise times longer than the specified maximum.

## 5.3. Electrical Specifications

### 5.3.1. General Radio Characteristics

Symbol	Description	Min.	Typ.	Max.	Units
$f_{OP}$	Operating frequencies	2360		2500	MHz
$f_{PLL,CH,SP}$	PLL channel spacing		1		MHz
$f_{DELTA,1M}$	Frequency deviation @ 1 Mbps		$\pm 170$		kHz
$f_{DELTA,BLE,1M}$	Frequency deviation @ BLE 1 Mbps		$\pm 250$		kHz
$f_{DELTA,2M}$	Frequency deviation @ 2 Mbps		$\pm 320$		kHz
$f_{DELTA,BLE,2M}$	Frequency deviation @ BLE 2 Mbps		$\pm 500$		kHz
$f_{skBPS}$	On the air data rate	125		2000	kbps
$f_{chip, IEEE 802.15.4}$	Chip rate in IEEE 802.15.4 mode		2000		kchips

### 5.3.2. Radio Current Consumption (Transmitter)

Symbol	Description	Min.	Typ.	Max.	Units
$I_{TX,PLUS8dBm,DCDC}$	TX only run current (DC/DC, 3 V) $P_{RF} = +8$ dBm	..	14.8	..	mA
$I_{TX,PLUS8dBm}$	TX only run current $P_{RF} = +8$ dBm	..	32.7	..	mA
$I_{TX,PLUS4dBm,DCDC}$	TX only run current (DC/DC, 3 V) $P_{RF} = +4$ dBm	..	9.6	..	mA
$I_{TX,PLUS4dBm}$	TX only run current $P_{RF} = +4$ dBm	..	21.4	..	mA
$I_{TX,0dBm,DCDC,5V,REG0HIGH}$	TX only run current (DC/DC, 5 V, REG0 out = 3.3 V) $P_{RF} = 0$ dBm		3.0		mA
$I_{TX,0dBm,DCDC,5V,REG0L}$	TX only run current (DC/DC, 5 V, REG0 out = 1.8 V) $P_{RF} = 0$ dBm		3.0		mA
$I_{TX,0dBm,DCDC}$	TX only run current (DC/DC, 3 V) $P_{RF} = 0$ dBm	..	4.8	8.7	mA
$I_{TX,0dBm}$	TX only run current $P_{RF} = 0$ dBm	..	10.6	..	mA
$I_{TX,MINUS4dBm,DCDC}$	TX only run current DC/DC, 3 V $P_{RF} = -4$ dBm	..	3.1	..	mA
$I_{TX,MINUS4dBm}$	TX only run current $P_{RF} = -4$ dBm	..	8.1	..	mA
$I_{TX,MINUS8dBm,DCDC}$	TX only run current DC/DC, 3 V $P_{RF} = -8$ dBm		3.3		mA
$I_{TX,MINUS8dBm}$	TX only run current $P_{RF} = -8$ dBm	..	7.2	7.9	mA
$I_{TX,MINUS12dBm,DCDC}$	TX only run current DC/DC, 3 V $P_{RF} = -12$ dBm		3.0		mA
$I_{TX,MINUS12dBm}$	TX only run current $P_{RF} = -12$ dBm	..	6.4	..	mA
$I_{TX,MINUS16dBm,DCDC}$	TX only run current DC/DC, 3 V $P_{RF} = -16$ dBm		2.8		mA
$I_{TX,MINUS16dBm}$	TX only run current $P_{RF} = -16$ dBm	..	6.0	..	mA
$I_{TX,MINUS20dBm,DCDC}$	TX only run current DC/DC, 3 V $P_{RF} = -20$ dBm		2.7		mA
$I_{TX,MINUS20dBm}$	TX only run current $P_{RF} = -20$ dBm	..	5.6	..	mA

Symbol	Description	Min.	Typ.	Max.	Units
$I_{TX,MINUS40dBm,DCDC}$	TX only run current DC/DC, 3 V $P_{RF} = -40$ dBm		2.3		mA
$I_{TX,MINUS40dBm}$	TX only run current $P_{RF} = -40$ dBm	..	4.6	..	mA
$I_{START,TX,DCDC}$	TX start-up current DC/DC, 3 V, $P_{RF} = 4$ dBm		5.2		mA
$I_{START,TX}$	TX start-up current, $P_{RF} = 4$ dBm		11.0		mA

### 5.3.3. Radio Current Consumption (Receiver)

Symbol	Description	Min.	Typ.	Max.	Units
$I_{RX,1M,DCDC}$	RX only run current (DC/DC, 3 V) 1 Mbps / 1 Mbps BLE	..	4.6	..	mA
$I_{RX,1M}$	RX only run current (LDO, 3 V) 1 Mbps / 1 Mbps BLE	..	9.9	..	mA
$I_{RX,2M,DCDC}$	RX only run current (DC/DC, 3 V) 2 Mbps / 2 Mbps BLE	..	5.2	..	mA
$I_{RX,2M}$	RX only run current (LDO, 3 V) 2 Mbps / 2 Mbps BLE	..	11.1	..	mA
$I_{START,RX,1M,DCDC}$	RX start-up current (DC/DC, 3 V) 1 Mbps / 1 Mbps BLE		3.7		mA
$I_{START,RX,1M}$	RX start-up current 1 Mbps / 1 Mbps BLE		6.7		mA

### 5.3.4. Transmitter Specification

Symbol	Description	Min.	Typ.	Max.	Units
$P_{RF}$	Maximum output power	..	8.0	..	dBm
$P_{RFC}$	RF power control range		28.0		dB
$P_{RFCR}$	RF power accuracy			$\pm 4$	dB
$P_{RF1,1}$	1st Adjacent Channel Transmit Power 1 MHz (1 Mbps)	..	-24.8	..	dBc
$P_{RF2,1}$	2nd Adjacent Channel Transmit Power 2 MHz (1 Mbps)	..	-54.0	..	dBc
$P_{RF1,2}$	1st Adjacent Channel Transmit Power 2 MHz (2 Mbps)	..	-25	..	dBc
$P_{RF2,2}$	2nd Adjacent Channel Transmit Power 4 MHz (2 Mbps)	..	-54.0	..	dBc
$E_{vm}$	Error vector magnitude IEEE 802.15.4	..	8	..	%rms
$P_{harm2nd, IEEE 802.15.4}$	2nd harmonics in IEEE 802.15.4 mode	..	-51.0	..	dBm
$P_{harm3rd, IEEE 802.15.4}$	3rd harmonics in IEEE 802.15.4		-48.0	..	dBm

## 5.3.5. Receiver Operation

Symbol	Description	Min.	Typ.	Max.	Units
P <sub>RX,MAX</sub>	Maximum received signal strength at < 0.1% PER		0		dBm
P <sub>SENS,IT,1M</sub>	Sensitivity, 1 Mbps nRF mode <sup>1</sup>		-93		dBm
P <sub>SENS,IT,SP,1M,BLE</sub>	Sensitivity, 1 Mbps BLE ideal transmitter, <=37 bytes BER=1E-3 <sup>2</sup>		-95		dBm
P <sub>SENS,IT,LP,1M,BLE</sub>	Sensitivity, 1 Mbps BLE ideal transmitter >=128 bytes BER=1E-4 <sup>3</sup>		-94.0		dBm
P <sub>SENS,IT,2M</sub>	Sensitivity, 2 Mbps nRF mode <sup>4</sup>				dBm
P <sub>SENS,IT,SP,2M,BLE</sub>	Sensitivity, 2 Mbps BLE ideal transmitter, Packet length <=37 bytes		-92		dBm
P <sub>SENS,IT,BLE LE125k</sub>	Sensitivity, 125 kbps BLE mode		-103.0		dBm
P <sub>SENS,IT,BLE LE500k</sub>	Sensitivity, 500 kbps BLE mode		-99		dBm
P <sub>sense, IEEE 802.15.4</sub>	Sensitivity in IEEE 802.15.4 mode		-100		dBm

1. Typical sensitivity applies when ADDR0 is used for receiver address correlation. When ADDR [1...7] are used for receiver address correlation, the typical sensitivity for this mode is degraded by 3dB.
2. As defined in the Bluetooth Core Specification v4.0 Volume 6: Core System Package (Low Energy Controller Volume).
3. Equivalent BER limit < 10E-04.
4. Same as remark 1.

## 5.3.6. RX Selectivity

Symbol	Description	Min.	Typ.	Max.	Units
C/I <sub>1M,co-channel</sub>	1Mbps mode, Co-Channel interference		9		dB
C/I <sub>1M,-1MHz</sub>	1 Mbps mode, Adjacent (-1 MHz) interference		-2		dB
C/I <sub>1M,+1MHz</sub>	1 Mbps mode, Adjacent (+1 MHz) interference		-10		dB
C/I <sub>1M,-2MHz</sub>	1 Mbps mode, Adjacent (-2 MHz) interference		-19		dB
C/I <sub>1M,+2MHz</sub>	1 Mbps mode, Adjacent (+2 MHz) interference		-42		dB
C/I <sub>1M,-3MHz</sub>	1 Mbps mode, Adjacent (-3 MHz) interference		-38		dB
C/I <sub>1M,+3MHz</sub>	1 Mbps mode, Adjacent (+3 MHz) interference		-48		dB
C/I <sub>1M,±6MHz</sub>	1 Mbps mode, Adjacent (≥6 MHz) interference		-50		dB
C/I <sub>1MBLE,co-channel</sub>	1 Mbps BLE mode, Co-Channel interference		6		dB
C/I <sub>1MBLE,-1MHz</sub>	1 Mbps BLE mode, Adjacent (-1 MHz) interference		-2		dB
C/I <sub>1MBLE,+1MHz</sub>	1 Mbps BLE mode, Adjacent (+1 MHz) interference		-9		dB
C/I <sub>1MBLE,-2MHz</sub>	1 Mbps BLE mode, Adjacent (-2 MHz) interference		-22		dB
C/I <sub>1MBLE,+2MHz</sub>	1 Mbps BLE mode, Adjacent (+2 MHz) interference		-46		dB
C/I <sub>1MBLE,&gt;3MHz</sub>	1 Mbps BLE mode, Adjacent (≥3 MHz) interference		-50		dB
C/I <sub>1MBLE,image</sub>	Image frequency interference		-22		dB
C/I <sub>1MBLE,image,1MHz</sub>	Adjacent (1 MHz) interference to in-band image frequency		-35		dB
C/I <sub>2M,co-channel</sub>	2 Mbps mode, Co-Channel interference		10		dB

Symbol	Description	Min.	Typ.	Max.	Units
C/I <sub>2M,-2MHz</sub>	2 Mbps mode, Adjacent (-2 MHz) interference		6		dB
C/I <sub>2M,+2MHz</sub>	2 Mbps mode, Adjacent (+2 MHz) interference		-19		dB
C/I <sub>2M,-4MHz</sub>	2 Mbps mode, Adjacent (-4 MHz) interference		-20		dB
C/I <sub>2M,+4MHz</sub>	2 Mbps mode, Adjacent (+4 MHz) interference		-44		dB
C/I <sub>2M,-6MHz</sub>	2 Mbps mode, Adjacent (-6 MHz) interference		-42		dB
C/I <sub>2M,+6MHz</sub>	2 Mbps mode, Adjacent (+6 MHz) interference		-42		dB
C/I <sub>2M,≥12MHz</sub>	2 Mbps mode, Adjacent (≥12 MHz) interference		-52		dB
C/I <sub>2MBLE,co-channel</sub>	2 Mbps BLE mode, Co-Channel interference		6.8		dB
C/I <sub>2MBLE,±2MHz</sub>	2 Mbps BLE mode, Adjacent (±2 MHz) interference		-10		dB
C/I <sub>2MBLE,±4MHz</sub>	2 Mbps BLE mode, Adjacent (±4 MHz) interference		-45		dB
C/I <sub>2MBLE,≥6MHz</sub>	2 Mbps BLE mode, Adjacent (≥6 MHz) interference		-48		dB
C/I <sub>2MBLE,image</sub>	Image frequency interference		-24		dB
C/I <sub>2MBLE,image, 2MHz</sub>	Adjacent (2 MHz) interference to in-band image frequency		-35		dB
C/I <sub>125k BLE LR, co-channel</sub>	125 kbps BLE LR mode, Co-Channel interference		4.4		dB
C/I <sub>125k BLE LR,-1MHz</sub>	125 kbps BLE LR mode, Adjacent (-1 MHz) interference		-4.0		dB
C/I <sub>125k BLE LR,+1MHz</sub>	125 kbps BLE LR mode, Adjacent (+1 MHz) interference		-12		dB
C/I <sub>125k BLE LR,-2MHz</sub>	125 kbps BLE LR mode, Adjacent (-2 MHz) interference		-28		dB
C/I <sub>125k BLE LR,+2MHz</sub>	125 kbps BLE LR mode, Adjacent (+2 MHz) interference		-50		dB
C/I <sub>125k BLE LR,&gt;3MHz</sub>	125 kbps BLE LR mode, Adjacent (≥3 MHz) interference		-55		dB
C/I <sub>125k BLE LR,image</sub>	Image frequency interference		-29		dB

Remark: Wanted signal level at PIN = -67 dBm. One interferer is used, having equal modulation as the wanted signal. The input power of the interferer where the sensitivity equals BER = 0.1% is presented.

### 5.3.7. RX Intermodulation

Symbol	Description	Min.	Typ.	Max.	Units
P <sub>IMD,5TH,1M</sub>	IMD performance, 1 Msps, 5th offset channel, Packet length ≤ 37 bytes		-33		dBm
P <sub>IMD,5TH,1M,BLE</sub>	IMD performance, BLE 1 Msps, 5th offset channel, Packet length ≤ 37 bytes		-30		dBm
P <sub>IMD,5TH,2M</sub>	IMD performance, 2 Msps, 5th offset channel, Packet length ≤ 37 bytes		-33		dBm
P <sub>IMD,5TH,2M,BLE</sub>	IMD performance, BLE 2 Msps, 5th offset channel, Packet length ≤ 37 bytes		-31		dBm

Remark: Wanted signal level at PIN = -64dBm. Two interferers with equal input power are used. The interferer closest in frequency is not modulated, the other interferer is modulated equal with the wanted signal. The input power of the interferers where the sensitivity equals BER = 0.1% is presented.



## 5.3.8. Radio Timing Parameters

Symbol	Description	Min.	Typ.	Max.	Units
$t_{TXEN}$	Time between TXEN task and READY event after channel FREQUENCY configured		140		$\mu s$
$t_{TXEN,FAST}$	Time between TXEN task and READY event after channel FREQUENCY configured (fast Mode)		40		$\mu s$
$t_{TXDISABLE}$	Time between DISABLE task and DISABLED event when the radio was in TX and mode is set to 1Mbps		6		$\mu s$
$t_{TXDISABLE,2M}$	Time between DISABLE task and DISABLED event when the radio was in TX and mode is set to 2Mbps		4		$\mu s$
$t_{RXEN}$	Time between the RXEN task and READY event after channel FREQUENCY configured in default mode		140		$\mu s$
$t_{RXEN,FAST}$	Time between the RXEN task and READY event after channel FREQUENCY configured in fast mode		40		$\mu s$
$t_{RXDISABLE}$	Time between DISABLE task and DISABLED event when the radio was in RX		0		$\mu s$
$t_{RX-to-TX \text{ turnaround}}$	Maximum TX-to-RX or RX-to-TX turnaround time in IEEE 802.15.4 mode	..	..	..	$\mu s$

## 5.3.9. RSSI Specifications

Symbol	Description	Min.	Typ.	Max.	Units
$RSSI_{ACC}$	RSSI accuracy valid range -90 to -20 dBm		+2		dB
$RSSI_{RESOLUTION}$	RSSI resolution		1		dB
$RSSI_{PERIOD}$	Sample period		15.0		$\mu s$

## 5.3.10. CPU

Symbol	Description	Min.	Typ.	Max.	Units
$W_{FLASH}$	CPU wait states, running CoreMark from flash, cache disabled			2	
$W_{FLASHCACHE}$	CPU wait states, running CoreMark from flash, cache enabled			3	
$W_{RAM}$	CPU wait states, running CoreMark from RAM			0	
$CM_{FLASH}$	CoreMark, running CoreMark from flash, cache enabled		212		Coref
$CM_{FLASH/MHz}$	CoreMark per MHz, running CoreMark from flash, cache enabled		3.3		CoreMark/ MHz
$CM_{FLASH/mA}$	CoreMark per mA, running CoreMark from flash, cache enabled, DCDC 3V		59		Coref mA

## 5.3.11. Power Management

Symbol	Description	Min.	Typ.	Max.	Units
I <sub>ON_RAMOFF_EVENT</sub>	System ON, no RAM retention, wake on any event		0.97		μA
I <sub>ON_RAMON_EVENT</sub>	System ON, full 256 kB RAM retention, wake on any event		2.35		μA
I <sub>ON_RAMON_POF</sub>	System ON, full 256 kB RAM retention, wake on any event, power-fail comparator enabled		2.35		μA
I <sub>ON_RAMON_GPIOTE</sub>	System ON, full 256 kB RAM retention, wake on GPIOTE input (event mode)		17.37		μA
I <sub>ON_RAMON_GPIOTEPORT</sub>	System ON, full 256 kB RAM retention, wake on GPIOTE PORT event		2.36		μA
I <sub>ON_RAMOFF_RTC</sub>	System ON, no RAM retention, wake on RTC (running from LFRC clock)		1.5		μA
I <sub>ON_RAMON_RTC</sub>	System ON, full 256 kB RAM retention, wake on RTC (running from LFRC clock)		3.16		μA
I <sub>OFF_RAMOFF_RESET</sub>	System OFF, no RAM retention, wake on reset		0.40		μA
I <sub>OFF_RAMOFF_LPCOMP</sub>	System OFF, no RAM retention, wake on LPCOMP		0.86		μA
I <sub>OFF_RAMON_RESET</sub>	System OFF, full 256 kB RAM retention, wake on reset		1.86		μA
I <sub>ON_RAMOFF_EVENT_5V</sub>	System ON, no RAM retention, wake on any event, 5 V supply on VDDH, REG0 output = 3.3 V		1.29		μA
I <sub>OFF_RAMOFF_RESET_5V</sub>	System OFF, no RAM retention, wake on reset, 5 V supply on VDDH, REG0 output = 3.3 V		0.95		μA

# 6. Block Diagram

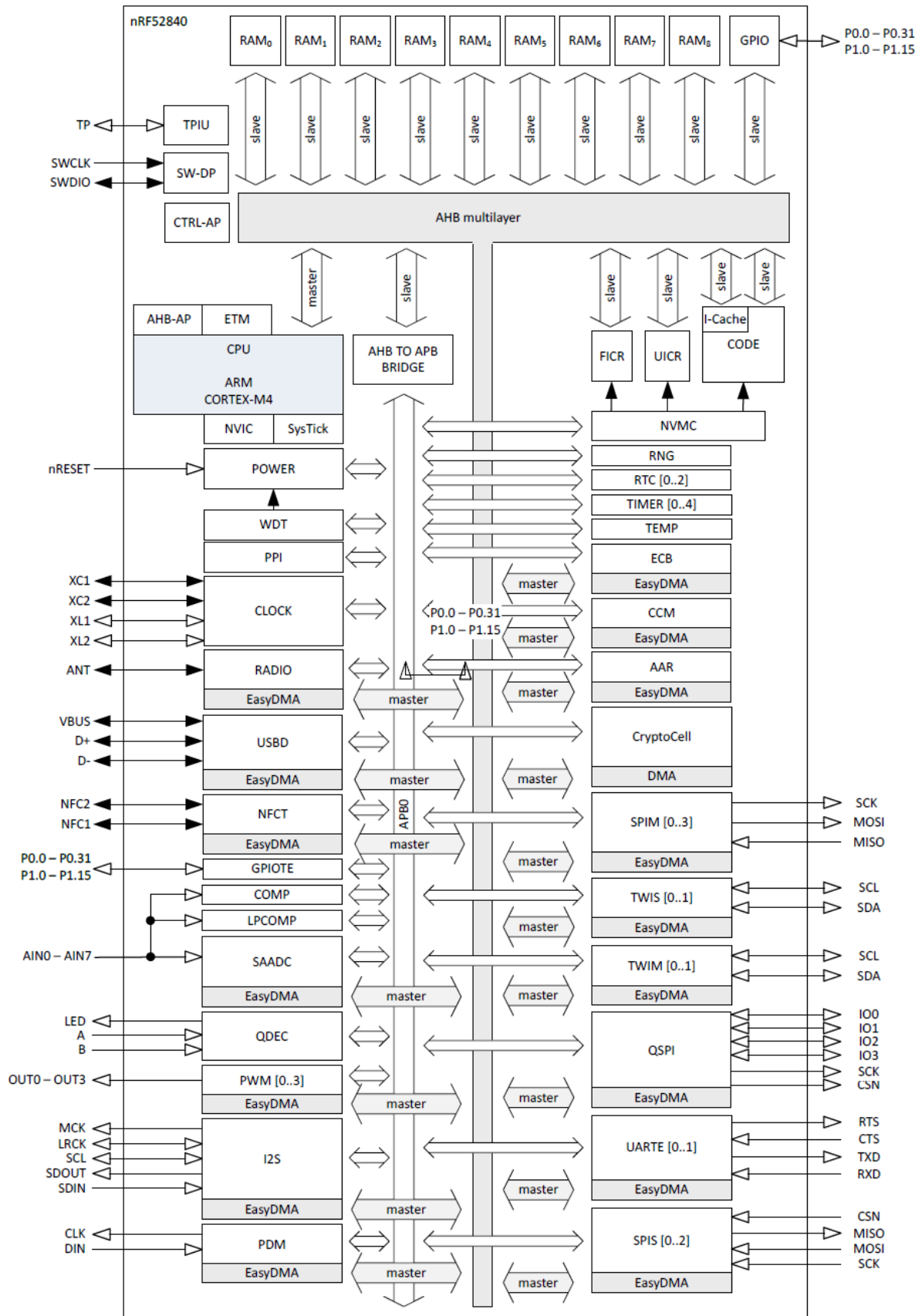

# 7. Antenna

## 7.1. MDBT50Q Series

### Antenna Gain and Efficiency

MDBT50Q (CHIP antenna)			
Freq(MHz)	Peak. dBi	Efficiency	Average . dBi
2400.00	-1.47	25.18%	-5.99
2410.00	-1.27	26.07%	-5.84
2420.00	-1.32	27.15%	-5.66
2430.00	-1.12	28.51%	-5.45
2440.00	-0.80	29.41%	-5.32
2450.00	-0.65	29.59%	-5.29
2460.00	-0.82	28.98%	-5.38
2470.00	-0.94	29.31%	-5.33
2480.00	-0.88	29.12%	-5.36
2490.00	-0.98	27.60%	-5.59
2500.00	-1.49	24.96%	-6.03

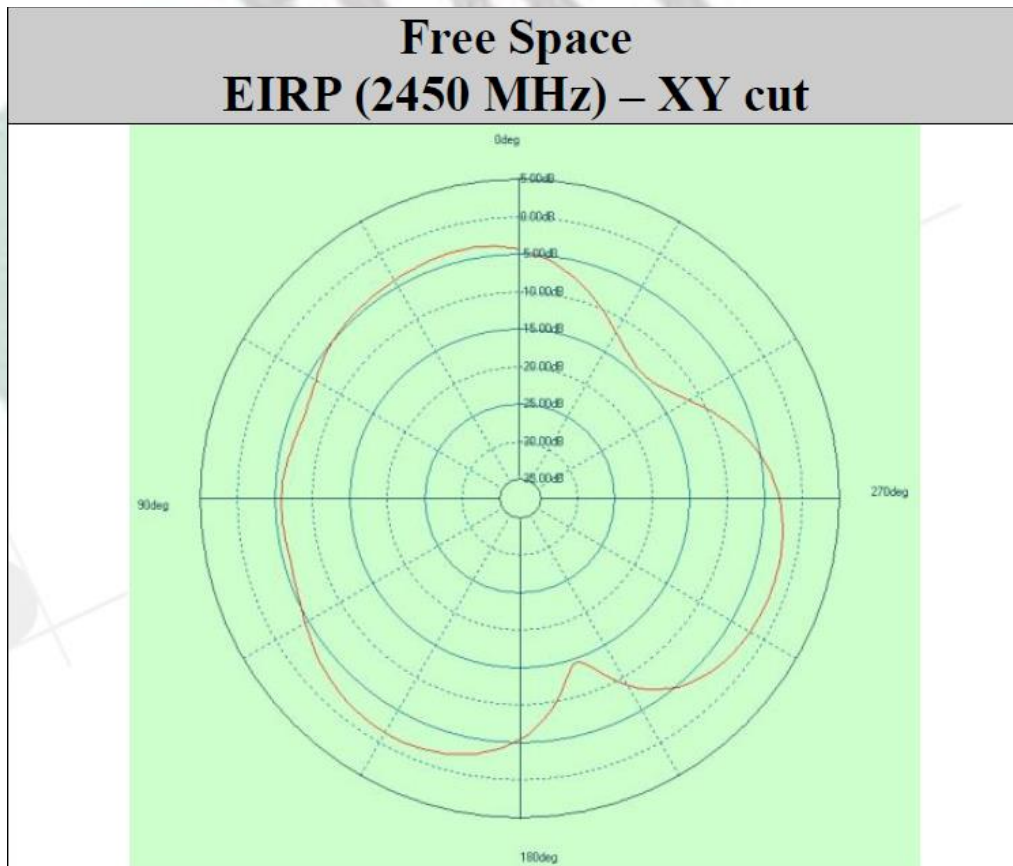

## Free Space EIRP (2450 MHz) – XZ cut

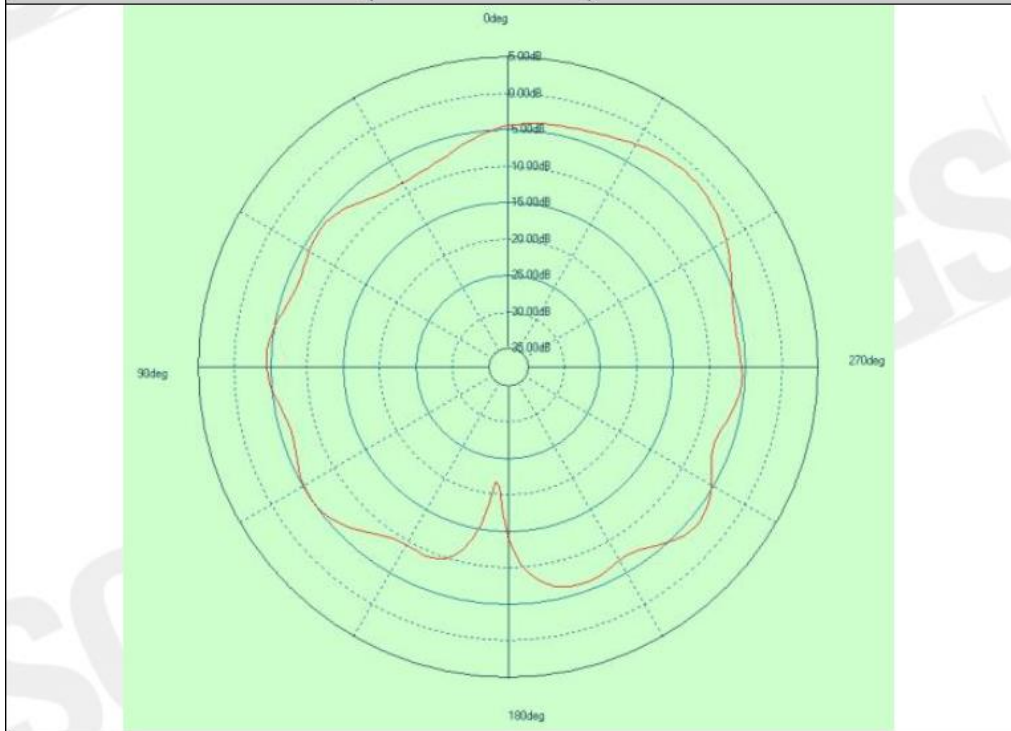

## Free Space EIRP (2450 MHz) – YZ cut

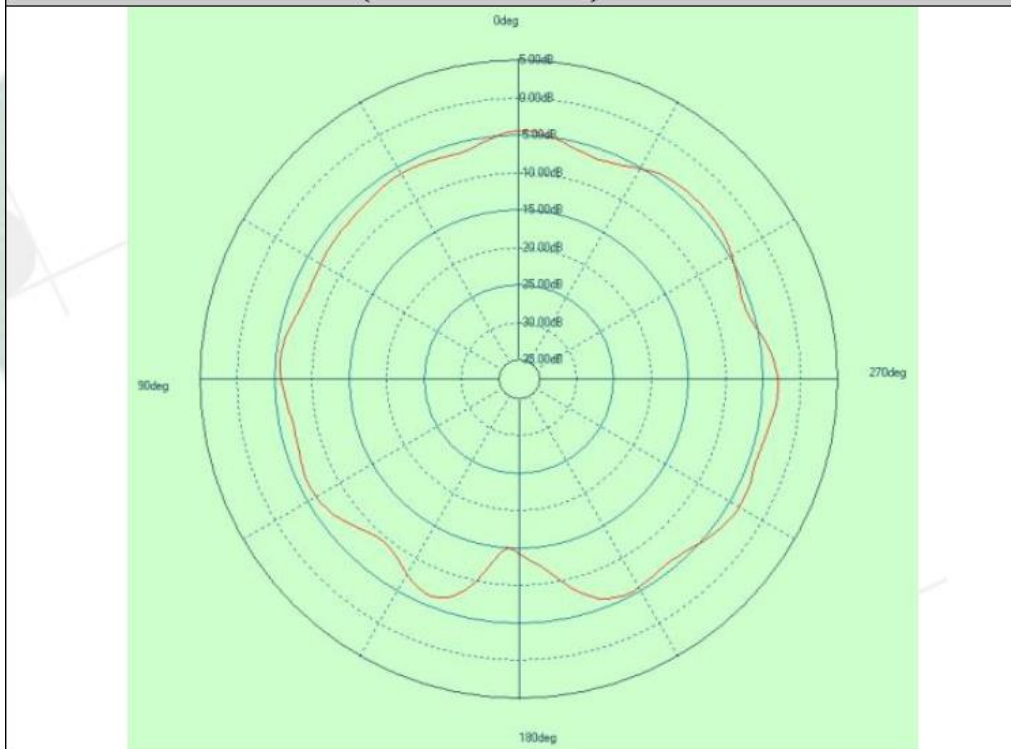

## 7.2. MDBT50Q-P Series

### Antenna Gain and Efficiency

MDBT50Q (PCB antenna)			
Freq(MHz)	Peak. dBi	Efficiency	Average . dBi
2400.00	-0.72	29.40%	-5.32
2410.00	-0.62	31.02%	-5.08
2420.00	-0.44	32.89%	-4.83
2430.00	-0.44	35.00%	-4.56
2440.00	0.08	36.98%	-4.32
2450.00	0.05	37.76%	-4.23
2460.00	0.24	37.40%	-4.27
2470.00	0.26	37.43%	-4.27
2480.00	0.41	36.96%	-4.32
2490.00	0.37	35.03%	-4.56
2500.00	-0.15	31.71%	-4.99

### Free Space EIRP (2450 MHz) – XY cut

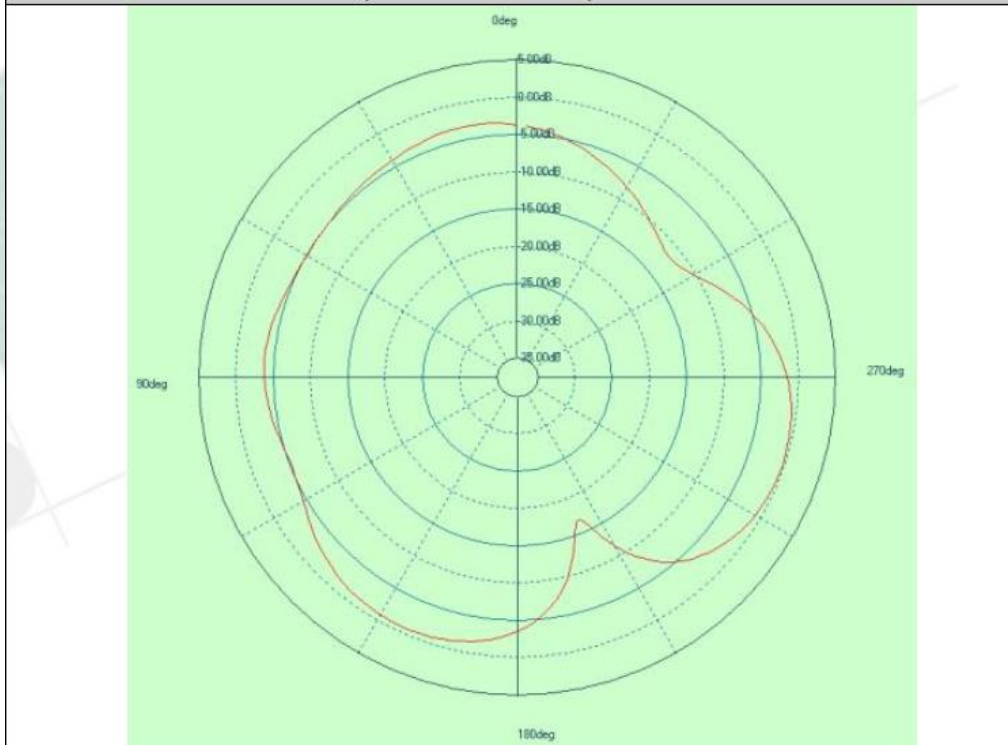

## Free Space EIRP (2450 MHz) – XZ cut

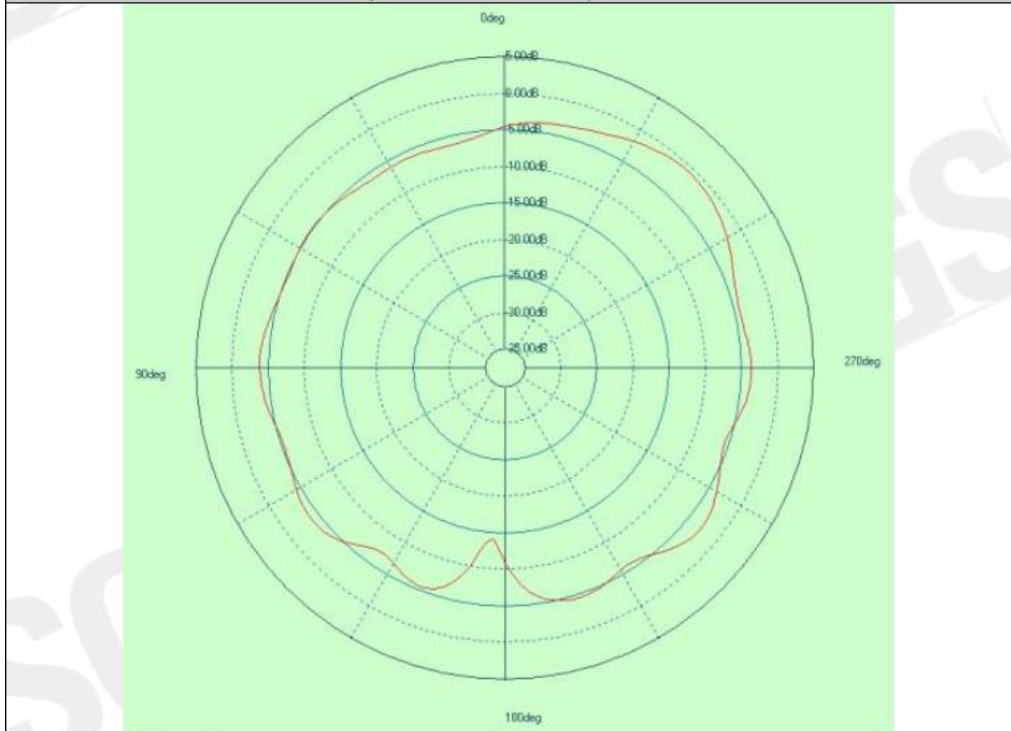

## Free Space EIRP (2450 MHz) – YZ cut

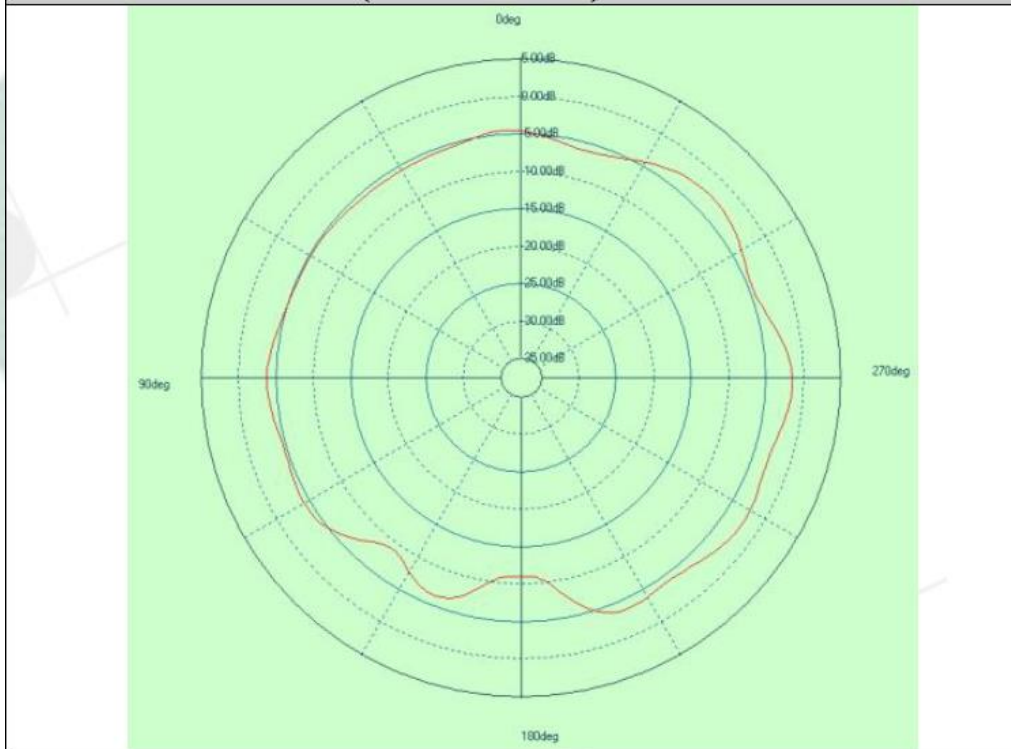

# 8. Reference Circuit

Module's default is using "DC-DC mode", and must connect it to external 32.768khz to work.

### REMARK:

**\*\* When NOT using DC-DC (VDDH) mode, please remove L4. \*\***  
**(L4 spec: 10μH, 0603 Chip Inductor, IDC, min = 80mA, ±20%)**

**\*\* When NOT using NFC, please remove NFC1 / C19 / C21. \*\***

**\*\* When using internal 32.768khz RC oscillator, please remove X2 / C12 / C13. \*\***

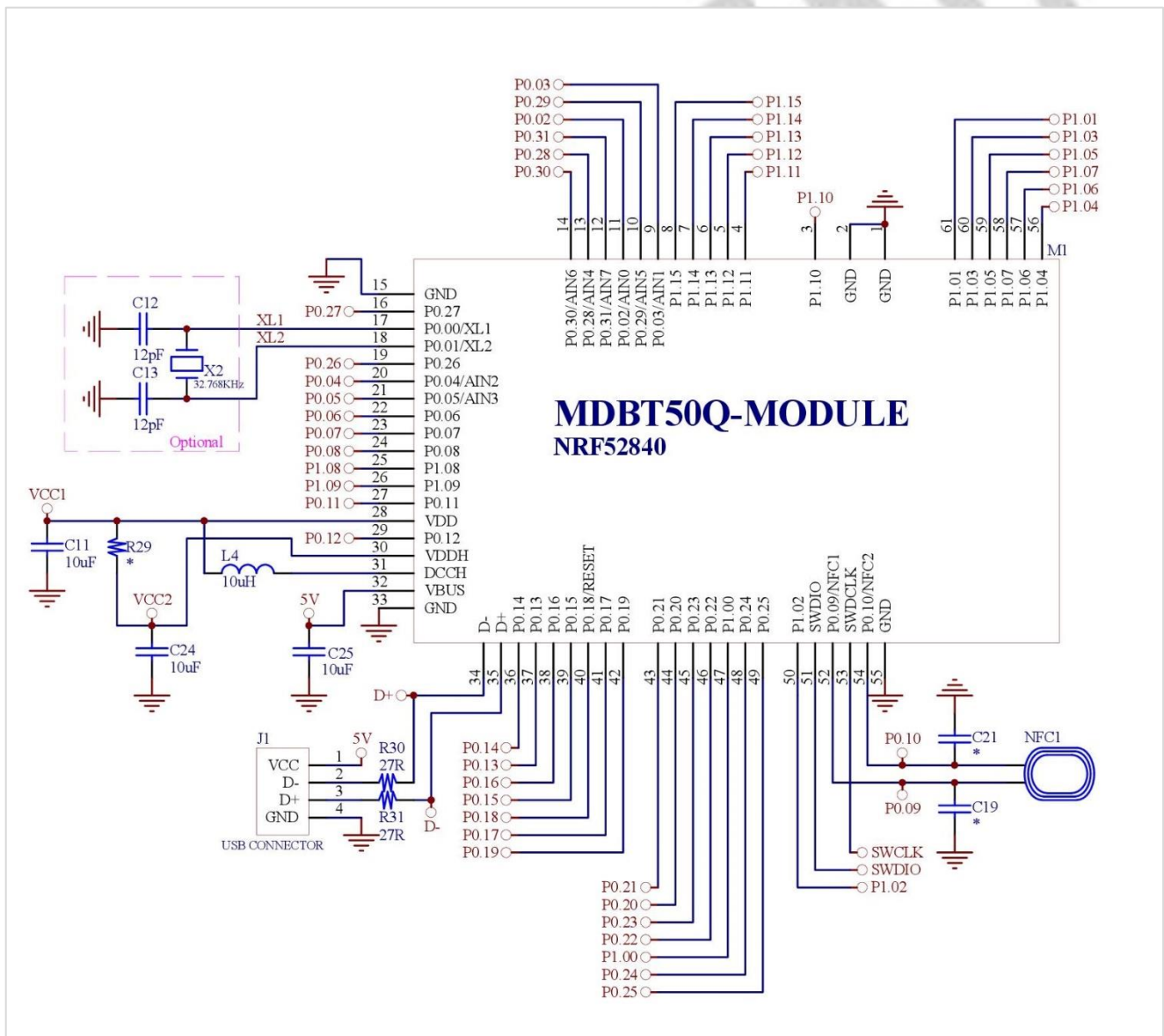



## 9. Certification

All certifications are pending. It is estimated to be available in July of 2018.

## 10. Notes and Cautions

Module is not designed to be used and lasting a lifetime. Like general products, it is expected to be worn out after continuous usage through the years. To assure that product will perform better and last longer, please

- Follow the guidelines of this document while designing circuit/end-product. Any discrepancy of core Bluetooth technology and technical specification of IC should refer to definition of Bluetooth Organization and Nordic Semiconductor as final reference.
- Do not supply voltage that is not within range of specification.
- Eliminate static electricity at any methods when working with the module as it may cause damage. It is highly recommended adding anti-ESD components to circuit design to prevent damage from real-life ESD events. Anti-ESD methods can be also applied in mechanical design.
- Do not expose modules under direct sunlight for long duration. Modules should be kept away from humid and salty air conditions, and any corrosive gasses or substances. Store it within  $-40^{\circ}\text{C}$  to  $+125^{\circ}\text{C}$  before and after installation.
- Avoid any physical shock, intense stress to the module or its surface.

The module is not suitable for life support device or system and not allowed to be used in destructive device or system in any direct, or indirect ways. The customer is agreeing to indemnify Raytac for any losses when applying modules under such application as described above.

# 11. Basic Facts for nRF52 Chip

Below is the comparison chart between nRF52840, nRF52832 and nRF52810. Any discrepancy shall refer to Nordic's technical document as final reference.

	nRF52840	nRF52832	nRF52810
<b>RAYTAC Model No.:</b>	Click to see " <a href="#">Full List of Raytac's BLE Modules</a> "		
<b>Bluetooth 5 Long Range (x4)</b>	V		
<b>Bluetooth 5 High Speed</b>	V	V	V
<b>Bluetooth 5 Advertisement Extension (x8)</b>	V	V	V
<b>Flash (kBytes)</b>	1024	512	192
<b>RAM (kBytes)</b>	256	64	24
<b>ANT</b>	V	V	V
<b>IEEE 802.15.4</b>	V		
<b>ARM® TrustZone® Cryptocell</b>	V		
<b>USB</b>	V		
<b>QSPI</b>	V		
<b>NFC</b>	V	V	
<b>I2S</b>	V	V	
<b>SPI, TWI, UART, PWM</b>	V	V	V
<b>PDM</b>	V	V	V
<b>ADC, Comparators</b>	V	V	V
<b>Supply Range (V)</b>	1.7 to 5.5	1.7 to 3.6	1.7 to 3.6

## 12. Useful Links

- **Nordic Infocenter:** <https://infocenter.nordicsemi.com/index.jsp>  
All the necessary technical files and software development kits of Nordic's chip are on this website.
- **Nordic Developer Zone:** <https://devzone.nordicsemi.com/questions/>  
A highly recommended website for firmware developer. Interact with other developers and Nordic's employees will help with your questions. The site also includes tutorials in detail to help you get started.
- **Official Page of nRF52840 :** <https://www.nordicsemi.com/eng/Products/nRF52840>  
A brief introduction to nRF52840 and download links for Nordic's developing software and SoftDevices.

# Full List of Raytac's BLE Modules

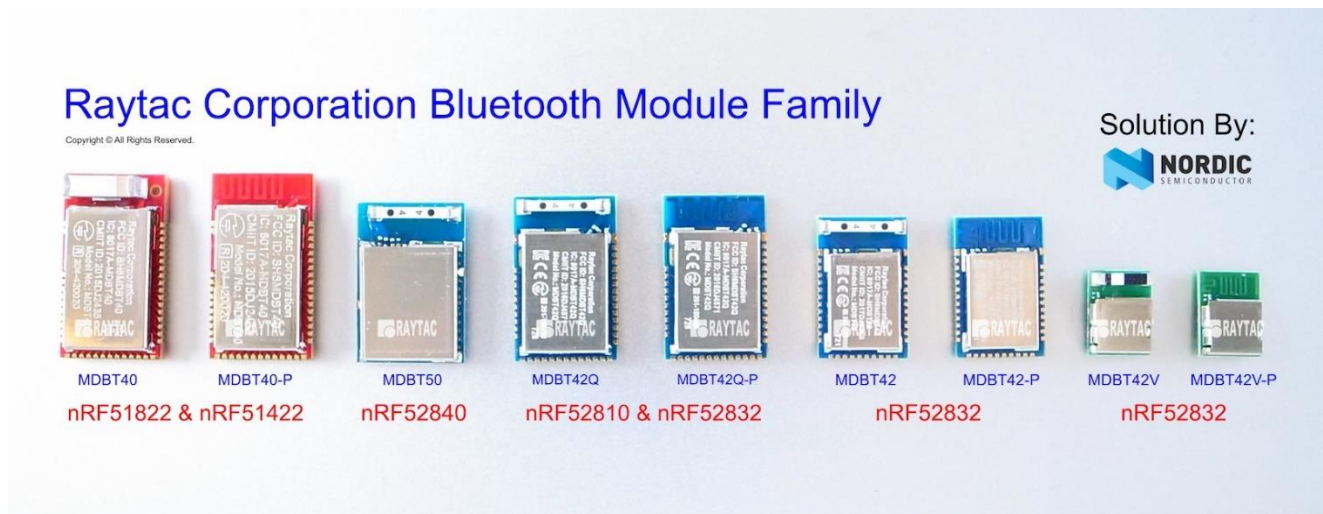

## MDBT40 & MDBT40-P Series

Series	Nordic Solution	Raytac No.	IC Version	Antenna	RAM	Flash Memory
MDBT40	nRF51822	MDBT40-256V3	3	Chip Antenna	16 kb	256 K
		MDBT40-256RV3			32 kb	256 K
MDBT40-P	nRF51822	MDBT40-P256V3	3	PCB Antenna	16 kb	256 K
		MDBT40-P256RV3			32 kb	256 K
MDBT40 - ANT	nRF51422	MDBT40-ANT-256V3	3	Chip Antenna	16 kb	256 K
		MDBT40-ANT-256RV3			32 kb	
MDBT40 - ANT-P	nRF51422	MDBT40-ANT-P256V3	3	PCB Antenna	16 kb	256 K
		MDBT40-ANT-P256RV3			32 kb	
MDBT40 Nano	nRF51822	MDBT40-n256V3	3	N/A	16 kb	256 K
MDBT40 - ANT-Nano	nRF51422	MDBT40-ANT-n256V3	3	N/A	16 kb	256 K

### MDBT42Q Series (QFN Package IC)

Series	Nordic Solution	Raytac No.	IC Version	Antenna	RAM	Flash Memory
MDBT42Q	nRF52832	MDBT42Q-512KV2	2	Chip Antenna	64 kb	512 K
	nRF52810	MDBT42Q-192K	1		24 kb	192 K

MDBT42Q-P	nRF52832	MDBT42Q-P512KV2	2	PCB Antenna	64 kb	512 K
	nRF52810	MDBT42Q-P192K	1		24 kb	192 K

### MDBT42 Series (WLCSP Package IC)

Series	Nordic Solution	Raytac No.	IC Version	Antenna	RAM	Flash Memory
MDBT42	nRF52832	MDBT42-512KV2	2	Chip Antenna	64 kb	512 K
MDBT42-P		MDBT42-P512KV2		PCB Antenna		

Series	Nordic Solution	Raytac No.	IC Version	Antenna	RAM	Flash Memory
MDBT42V	nRF52832	MDBT42V-512KV2	2	Chip Antenna	64 kb	512 K
MDBT42V-P		MDBT42V-P512KV2		PCB Antenna		

### MDBT50Q Series (aQFN Package IC)

Series	Nordic Solution	Raytac No.	IC Version	Antenna	RAM	Flash Memory
MDBT50Q	nRF52840	MDBT50Q-1M	1	Chip Antenna	256 kb	1MB
MDBT50Q-P		MDBT50Q-P1M		PCB Antenna		
MDBT50Q-U		MDBT50Q-U1M		u.FL Connector		

# Release Note

- 2017/10/30 Pre-release
- 2018/01/19 Model no. officially changed to MDBT50Q-1M & MDBT50Q-P1M.
- 2018/04/10 Version A (1<sup>st</sup> release)
- 2018/06/12 Version B

(1) Added Chapter 4: Shipment Packaging Info and Chapter 7: Antenna.

