

Analog Devices Welcomes Hittite Microwave Corporation

NO CONTENT ON THE ATTACHED DOCUMENT HAS CHANGED



THIS PAGE INTENTIONALLY LEFT BLANK



GaAs InGaP HBT MMIC BROADBAND AMPLIFIER GAIN BLOCK, DC - 6 GHz

Typical Applications

Ideal as a Driver & Amplifier for:

- 2.2 - 2.7 GHz MMDS
- 3.5 GHz Wireless Local Loop
- 5 - 6 GHz UNII & HiperLAN

Features

- P1dB Output Power: +14 dBm
- Output IP3: +27 dBm
- Gain: 17 dB
- Single Supply: +5V
- High Reliability GaAs HBT Process
- Ultra Small Package: SOT26
- Included in the HMC-DK001 Designer's Kit

Functional Diagram

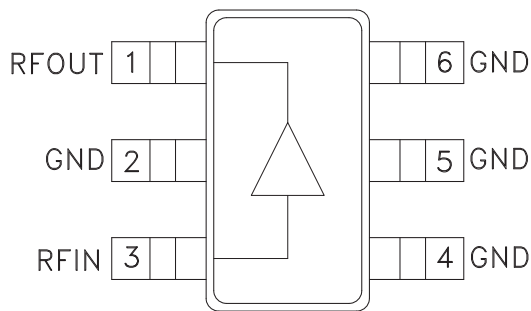

General Description

The HMC313 & HMC313E are GaAs InGaP Heterojunction Bipolar Transistor (HBT) MMIC amplifiers that operate from a single Vcc supply. The surface mount SOT26 amplifier can be used as a broadband gain stage or used with external matching for optimized narrow band applications. With Vcc biased at +5V, the HMC313(E) offers 17 dB of gain and +15 dBm of saturated power while only requiring 50 mA of current.

Electrical Specifications, $T_A = +25^\circ\text{C}$, $V_{CC} = +5.0\text{V}$

| Parameter | Vcc = +5V | | | Units |
|--|-----------|------|------|-------|
| | Min. | Typ. | Max. | |
| Frequency Range | DC - 6 | | | GHz |
| Gain | 14 | 17 | 20 | dB |
| Gain Variation Over Temperature | | 0.02 | 0.03 | dB/°C |
| Input Return Loss | | 7 | | dB |
| Output Return Loss | | 6 | | dB |
| Reverse Isolation | | 30 | | dB |
| Output Power for 1 dB Compression (P1dB) @ 1.0 GHz | 11 | 14 | | dBm |
| Saturated Output Power (Psat) @ 1.0 GHz | | 15 | | dBm |
| Output Third Order Intercept (IP3) @ 1.0 GHz | 24 | 27 | | dBm |
| Noise Figure | | 6.5 | | dB |
| Supply Current (Icc) | | 50 | | mA |

Note: Data taken with broadband bias tee on device output.

For price, delivery, and to place orders, please contact Hittite Microwave Corporation:
 20 Alpha Road, Chelmsford, MA 01824 Phone: 978-250-3343 Fax: 978-250-3373
 Order On-line at www.hittite.com

GaAs InGaP HBT MMIC BROADBAND AMPLIFIER GAIN BLOCK, DC - 6 GHz

Gain & Return Loss

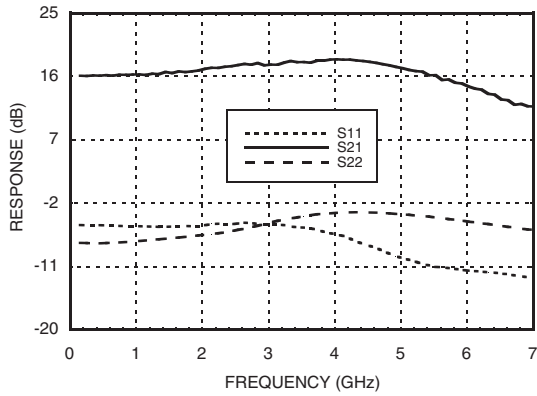

Gain vs. Temperature

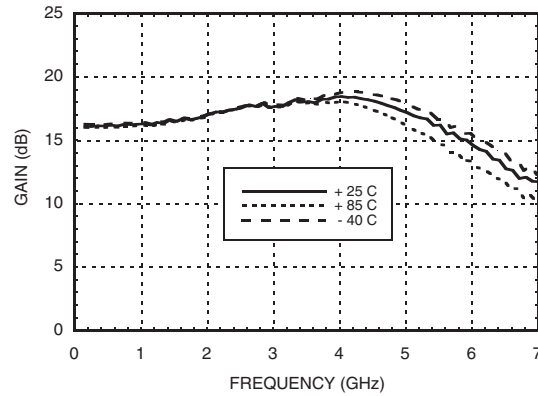

Input & Output Return Loss

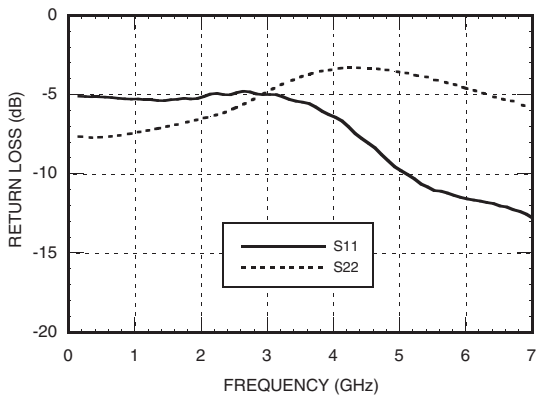

Reverse Isolation

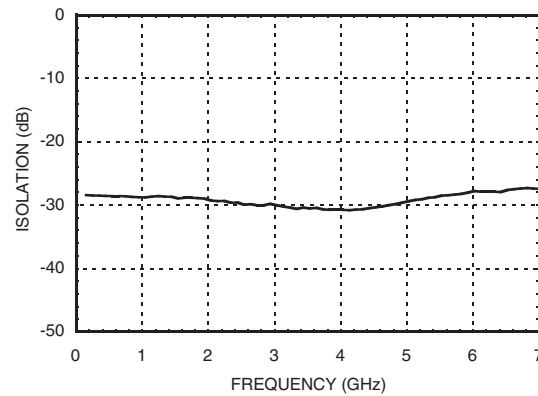

P1dB vs. Temperature

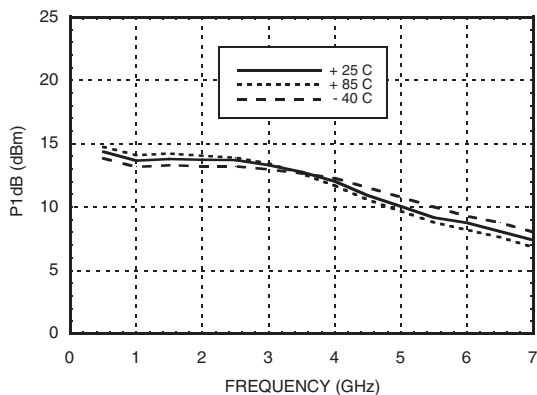

Psat vs. Temperature

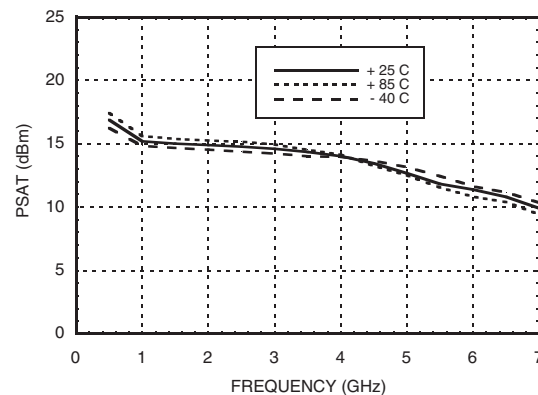



GaAs InGaP HBT MMIC BROADBAND AMPLIFIER GAIN BLOCK, DC - 6 GHz

Output IP3 vs. Temperature

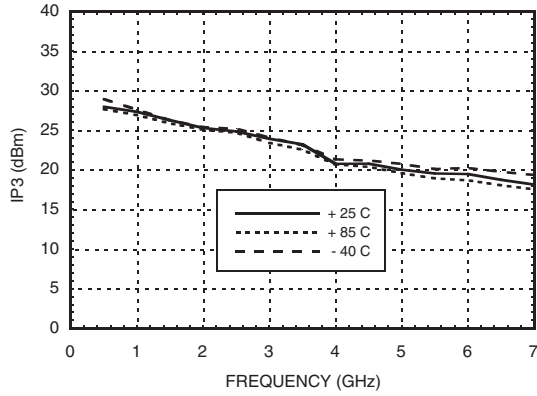

Power Compression @ 1 GHz

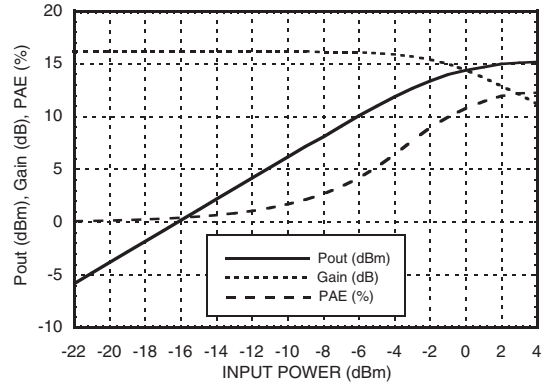

Power Compression @ 3 GHz

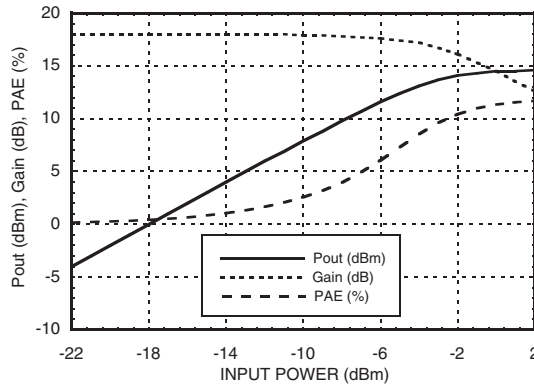

GaAs InGaP HBT MMIC BROADBAND AMPLIFIER GAIN BLOCK, DC - 6 GHz

Absolute Maximum Ratings

| | |
|---|----------------|
| Collector Bias Voltage (Vcc) | +5.5 Vdc |
| RF Input Power (RFIN)(Vcc = +5Vdc) | +20 dBm |
| Junction Temperature | 150 °C |
| Continuous P _{diss} (T = 85 °C) (derate 3.99 mW/°C above 85 °C) | 0.259 W |
| Thermal Resistance (junction to lead) | 251 °C/W |
| Storage Temperature | -65 to +150 °C |
| Operating Temperature | -40 to +85 °C |
| ESD Sensitivity (HBM) | Class 1A |



ELECTROSTATIC SENSITIVE DEVICE
OBSERVE HANDLING PRECAUTIONS

Outline Drawing

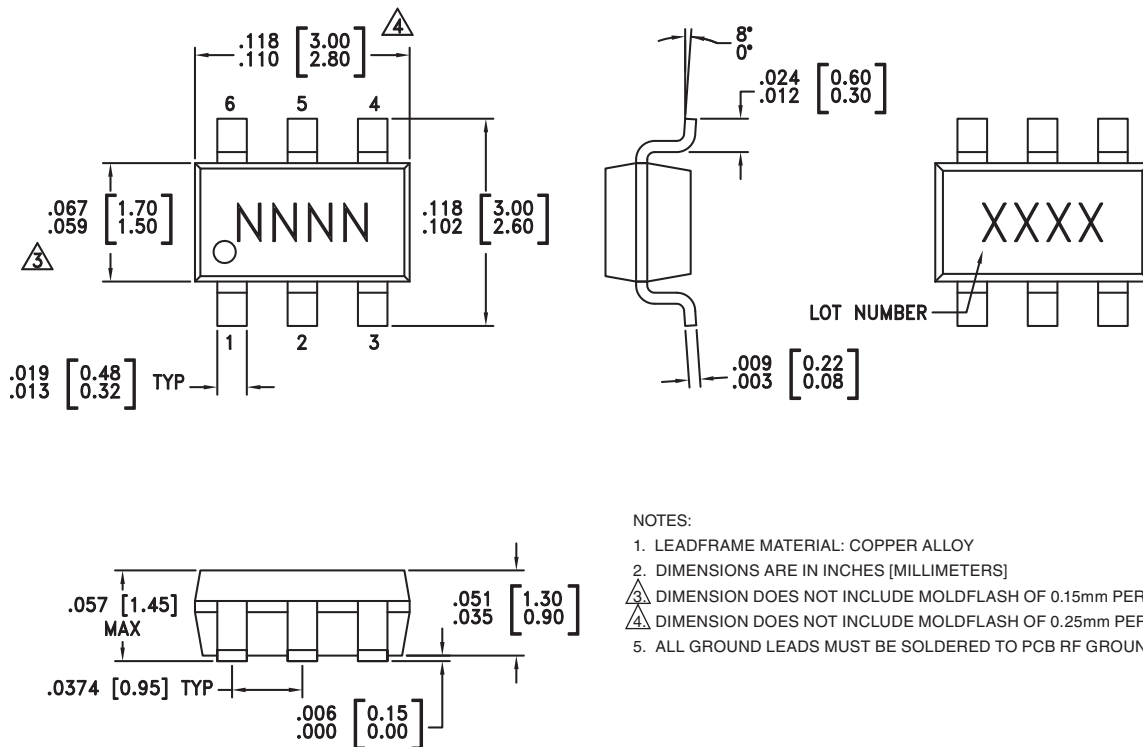

NOTES:

1. LEADFRAME MATERIAL: COPPER ALLOY
2. DIMENSIONS ARE IN INCHES [MILLIMETERS]
- △ DIMENSION DOES NOT INCLUDE MOLDFLASH OF 0.15mm PER SIDE.
- ▲ DIMENSION DOES NOT INCLUDE MOLDFLASH OF 0.25mm PER SIDE.
5. ALL GROUND LEADS MUST BE SOLDERED TO PCB RF GROUND

Package Information

| Part Number | Package Body Material | Lead Finish | MSL Rating | Package Marking ^[3] |
|-------------|--|---------------|---------------------|--------------------------------|
| HMC313 | Low Stress Injection Molded Plastic | Sn/Pb Solder | MSL1 ^[1] | H313 XXXX |
| HMC313E | RoHS-compliant Low Stress Injection Molded Plastic | 100% matte Sn | MSL1 ^[2] | 313E XXXX |



[1] Max peak reflow temperature of 235 °C

[2] Max peak reflow temperature of 260 °C

[3] 4-Digit lot number XXXX

For price, delivery, and to place orders, please contact Hittite Microwave Corporation:
20 Alpha Road, Chelmsford, MA 01824 Phone: 978-250-3343 Fax: 978-250-3373
Order On-line at www.hittite.com

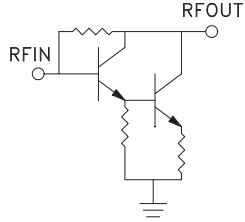
Pin Descriptions

| Pin Number | Function | Description | Interface Schematic |
|------------|----------|--|---|
| 1 | RFOUT | This pin is DC coupled. An off chip DC blocking capacitor is required. |  |
| 3 | RFIN | This pin is DC coupled. An off chip DC blocking capacitor is required. | |
| 2, 4-6 | GND | These pins must be connected to RF/DC ground. |  |

Application Circuit

Recommended Bias Resistor Values for $I_{cc} = 50\text{ mA}$, $R_{bias} = (V_s - 5.0) / I_{cc}$

| Supply Voltage (Vs) | 5V | 6V | 8V |
|---------------------|-----|------|------|
| RBIAS VALUE | 0 Ω | 20 Ω | 62 Ω |
| RBIAS POWER RATING | | ¼ W | ½ W |

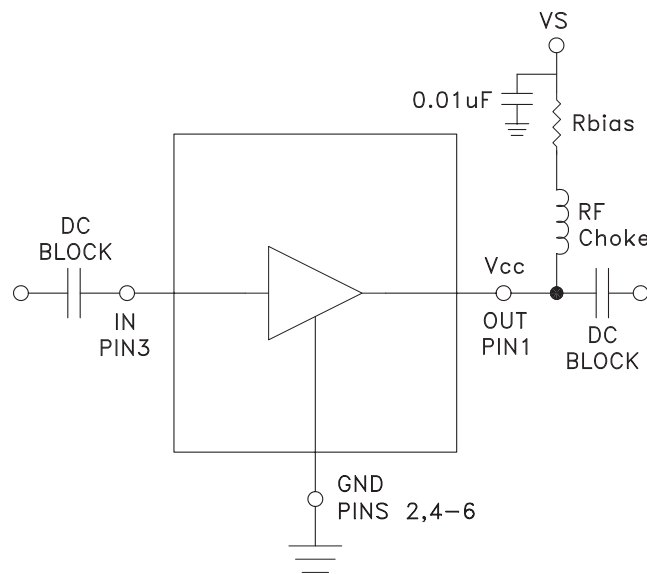

Note:

1. Select R_{bias} to achieve desired V_{cc} voltage on Pin 1.
2. External Blocking Capacitors are required on Pins 1 & 3.

Evaluation PCB

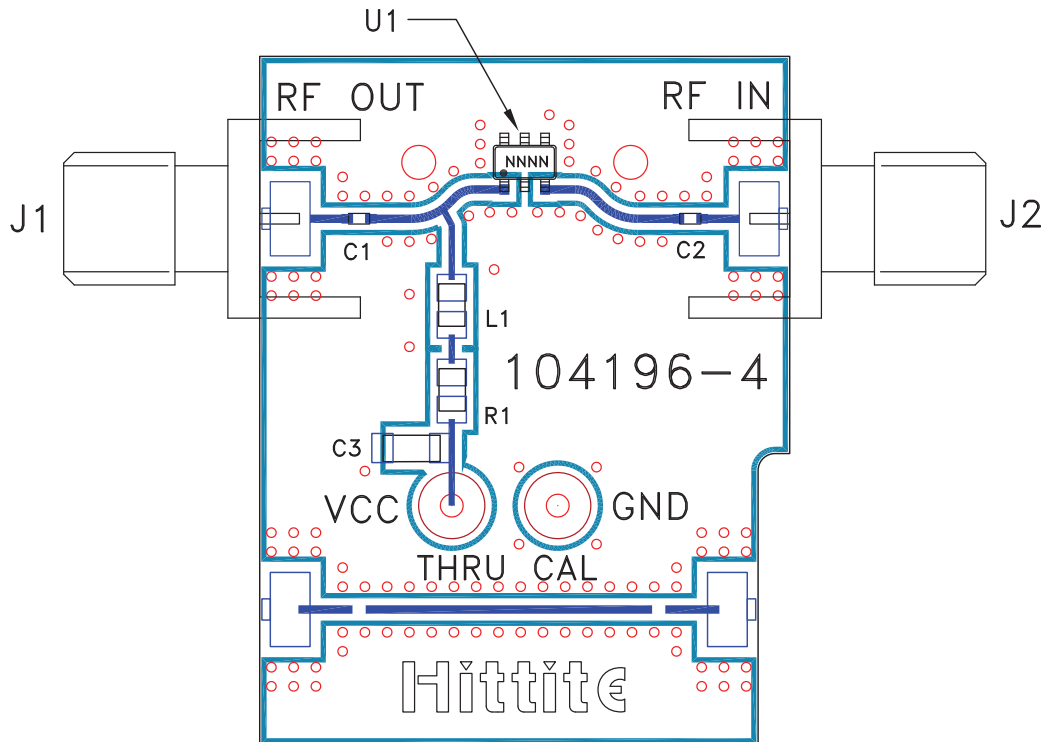

List of Materials for Evaluation PCB 104217 [1]

| Item | Description |
|---------|---------------------------------|
| J1 - J2 | PCB Mount SMA Connector |
| C1 - C2 | 100 pF Capacitor, 0402 Pkg. |
| C3 | 100 pF Capacitor, 0805 Pkg. |
| L1 | 22 nH Inductor, 0805 Pkg. |
| R1 | 22 Ω Resistor, 0805 Pkg. |
| U1 | HMC313 / HMC313E |
| PCB [2] | 104196 Evaluation PCB |

[1] Reference this number when ordering complete evaluation PCB

[2] Circuit Board Material: Arlon 25FR or Roger 4350

The circuit board used in the final application should use RF circuit design techniques. Signal lines should have 50 ohm impedance while the package ground leads should be connected directly to the ground plane similar to that shown. A sufficient number of via holes should be used to connect the top and bottom ground planes. The evaluation circuit board shown is available from Hittite upon request.