

# RF Power LDMOS Transistors

## N-Channel Enhancement-Mode Lateral MOSFETs

These high ruggedness devices are designed for use in high VSWR military, industrial (including laser and plasma exciters), broadcast (analog and digital), and radio/land mobile applications. They are unmatched input and output designs allowing wide frequency range utilization between 1.8 and 600 MHz.

- Typical Performance:  $V_{DD} = 50$  Vdc,  $I_{DQ} = 100$  mA

| Signal Type                           | $P_{out}$ (W) | f (MHz) | $G_{ps}$ (dB) | $\eta_D$ (%) | IRL (dB) |
|---------------------------------------|---------------|---------|---------------|--------------|----------|
| Pulse (100 $\mu$ sec, 20% Duty Cycle) | 300 Peak      | 230     | 26.5          | 74.0         | -16      |
| CW                                    | 300 Avg.      | 130     | 25.0          | 80.0         | -15      |

- Capable of Handling a Load Mismatch of 65:1 VSWR @ 50 Vdc, 230 MHz, at all Phase Angles
  - 300 W CW Output Power
  - 300 W Pulse Peak Power, 20% Duty Cycle, 100  $\mu$ sec
- Capable of 300 W CW Operation

### Features

- Unmatched Input and Output Allowing Wide Frequency Range Utilization
- Device can be used Single-Ended or in a Push-Pull Configuration
- Qualified Up to a Maximum of 50  $V_{DD}$  Operation
- Characterized from 30 V to 50 V for Extended Power Range
- Suitable for Linear Application with Appropriate Biasing
- Integrated ESD Protection
- Greater Negative Gate-Source Voltage Range for Improved Class C Operation
- Characterized with Series Equivalent Large-Signal Impedance Parameters
- NI-780H-4L in Tape and Reel. R5 Suffix = 50 Units, 56 mm Tape Width, 13-inch Reel.
- NI-780S-4L in Tape and Reel. R5 Suffix = 50 Units, 32 mm Tape Width, 13-inch Reel.

**Table 1. Maximum Ratings**

| Rating  | Symbol    | Value        | Unit                 |
|---|-----------|--------------|----------------------|
| Drain-Source Voltage  | $V_{DSS}$ | -0.5, +133   | Vdc                  |
| Gate-Source Voltage   | $V_{GS}$  | -6.0, +10    | Vdc                  |
| Storage Temperature Range   | $T_{stg}$ | -65 to +150  | $^{\circ}$ C         |
| Case Operating Temperature  | $T_C$     | 150          | $^{\circ}$ C         |
| Total Device Dissipation @ $T_C = 25^{\circ}$ C<br>Derate above 25 $^{\circ}$ C | $P_D$     | 1050<br>5.26 | W<br>W/ $^{\circ}$ C |
| Operating Junction Temperature (1,2)  | $T_J$     | 225          | $^{\circ}$ C         |

**Table 2. Thermal Characteristics**

| Characteristic   | Symbol                             | Value (2,3)  | Unit           |
|--|------------------------------------|--------------|----------------|
| Thermal Resistance, Junction to Case (4)<br>Pulse: Case Temperature 75 $^{\circ}$ C, 300 W Peak, 100 $\mu$ sec Pulse Width, 20% Duty Cycle,<br>50 Vdc, $I_{DQ} = 100$ mA, 230 MHz<br>CW: Case Temperature 87 $^{\circ}$ C, 300 W CW, 50 Vdc, $I_{DQ} = 1100$ mA, 230 MHz | $Z_{\theta JC}$<br>$R_{\theta JC}$ | 0.05<br>0.19 | $^{\circ}$ C/W |

- Continuous use at maximum temperature will affect MTTF.
- MTTF calculator available at <http://www.freescale.com/rf>. Select Software & Tools/Development Tools/Calculators to access MTTF calculators by product.
- Refer to AN1955, *Thermal Measurement Methodology of RF Power Amplifiers*. Go to <http://www.freescale.com/rf>. Select Documentation/Application Notes - AN1955.
- Same test circuit is used for both pulsed and CW.

**MMRF1310HR5**  
**MMRF1310HSR5**

**1.8-600 MHz, 300 W CW, 50 V  
BROADBAND  
RF POWER MOSFETs**

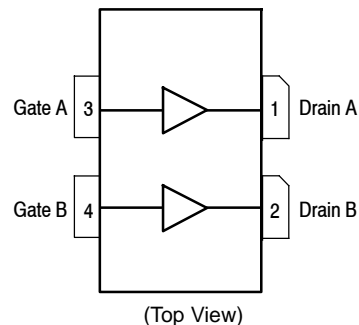
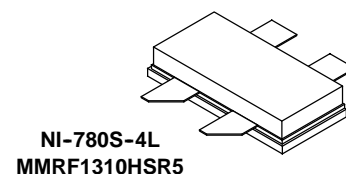
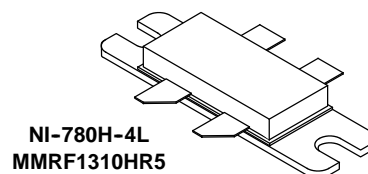

Note: The backside of the package is the source terminal for the transistors.

**Figure 1. Pin Connections**

**Table 3. ESD Protection Characteristics**

| Test Methodology                      | Class |
|---------------------------------------|-------|
| Human Body Model (per JESD22-A114)    | 2     |
| Machine Model (per EIA/JESD22-A115)   | B     |
| Charge Device Model (per JESD22-C101) | IV    |

**Table 4. Electrical Characteristics** ( $T_A = 25^\circ\text{C}$  unless otherwise noted)

| Characteristic | Symbol | Min | Typ | Max | Unit |
|----------------|--------|-----|-----|-----|------|
|----------------|--------|-----|-----|-----|------|

**Off Characteristics (1)**

|  |               |     |   |    |                 |
|--|---------------|-----|---|----|-----------------|
| Gate-Source Leakage Current<br>( $V_{GS} = 5\text{ Vdc}$ , $V_{DS} = 0\text{ Vdc}$ )               | $I_{GSS}$     | —   | — | 1  | $\mu\text{Adc}$ |
| Drain-Source Breakdown Voltage<br>( $V_{GS} = 0\text{ Vdc}$ , $I_D = 50\text{ mA}$ )               | $V_{(BR)DSS}$ | 133 | — | —  | Vdc             |
| Zero Gate Voltage Drain Leakage Current<br>( $V_{DS} = 50\text{ Vdc}$ , $V_{GS} = 0\text{ Vdc}$ )  | $I_{DSS}$     | —   | — | 5  | $\mu\text{Adc}$ |
| Zero Gate Voltage Drain Leakage Current<br>( $V_{DS} = 100\text{ Vdc}$ , $V_{GS} = 0\text{ Vdc}$ ) | $I_{DSS}$     | —   | — | 10 | $\mu\text{Adc}$ |

**On Characteristics**

|   |              |     |      |     |     |
|---|--------------|-----|------|-----|-----|
| Gate Threshold Voltage (1)<br>( $V_{DS} = 10\text{ Vdc}$ , $I_D = 480\ \mu\text{Adc}$ )                       | $V_{GS(th)}$ | 1.7 | 2.2  | 2.7 | Vdc |
| Gate Quiescent Voltage<br>( $V_{DD} = 50\text{ Vdc}$ , $I_D = 100\text{ mAdc}$ , Measured in Functional Test) | $V_{GS(Q)}$  | 2.0 | 2.5  | 3.0 | Vdc |
| Drain-Source On-Voltage (1)<br>( $V_{GS} = 10\text{ Vdc}$ , $I_D = 1\text{ Adc}$ )                            | $V_{DS(on)}$ | —   | 0.25 | —   | Vdc |

**Dynamic Characteristics (1)**

|   |           |   |     |   |    |
|---|-----------|---|-----|---|----|
| Reverse Transfer Capacitance<br>( $V_{DS} = 50\text{ Vdc} \pm 30\text{ mV(rms)ac}$ @ 1 MHz, $V_{GS} = 0\text{ Vdc}$ ) | $C_{rss}$ | — | 0.8 | — | pF |
| Output Capacitance<br>( $V_{DS} = 50\text{ Vdc} \pm 30\text{ mV(rms)ac}$ @ 1 MHz, $V_{GS} = 0\text{ Vdc}$ )           | $C_{oss}$ | — | 76  | — | pF |
| Input Capacitance<br>( $V_{DS} = 50\text{ Vdc}$ , $V_{GS} = 0\text{ Vdc} \pm 30\text{ mV(rms)ac}$ @ 1 MHz)            | $C_{iss}$ | — | 188 | — | pF |

**Functional Tests** (In Freescale Test Fixture, 50 ohm system)  $V_{DD} = 50\text{ Vdc}$ ,  $I_{DQ} = 100\text{ mA}$ ,  $P_{out} = 300\text{ W Peak}$  (60 W Avg.),  $f = 230\text{ MHz}$ , 100  $\mu\text{sec}$  Pulse Width, 20% Duty Cycle

|                   |          |      |      |      |    |
|-------------------|----------|------|------|------|----|
| Power Gain        | $G_{ps}$ | 25.0 | 26.5 | 28.0 | dB |
| Drain Efficiency  | $\eta_D$ | 72.0 | 74.0 | —    | %  |
| Input Return Loss | IRL      | —    | -16  | -9   | dB |

**Load Mismatch** (In Freescale Application Test Fixture, 50 ohm system)  $V_{DD} = 50\text{ Vdc}$ ,  $I_{DQ} = 100\text{ mA}$

|  |        |                                |  |  |  |
|--|--------|--------------------------------|--|--|--|
| VSWR 65:1 at all Phase Angles<br>Pulse: $P_{out} = 300\text{ W Peak}$ (60 W Avg.), $f = 230\text{ MHz}$ ,<br>100 $\mu\text{sec}$ Pulse Width, 20% Duty Cycle<br>CW: $P_{out} = 300\text{ W Avg.}$ , $f = 130\text{ MHz}$ | $\Psi$ | No Degradation in Output Power |  |  |  |
|--|--------|--------------------------------|--|--|--|

1. Each side of device measured separately.

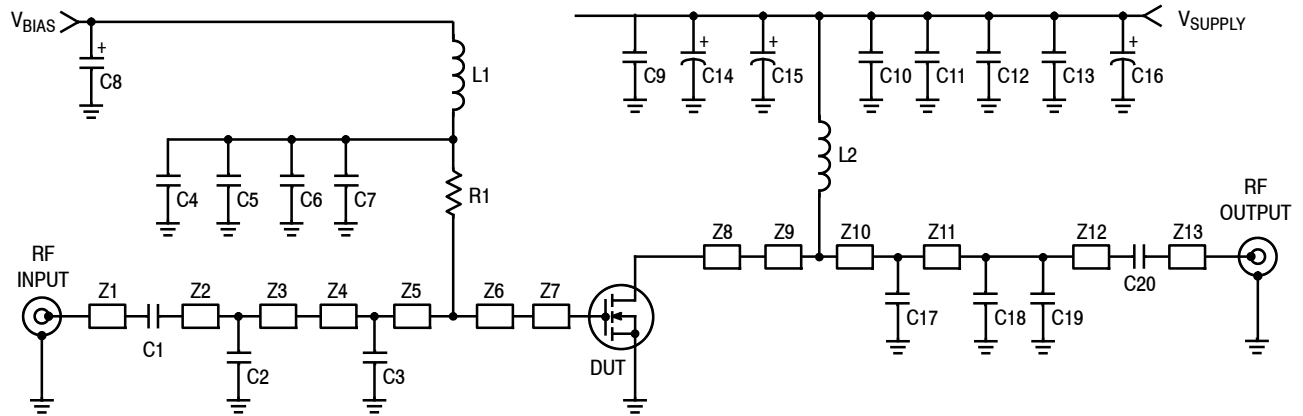

|        |                            |      |                            |
|--------|----------------------------|------|----------------------------|
| Z1     | 0.352" x 0.080" Microstrip | Z9   | 0.192" x 0.170" Microstrip |
| Z2*    | 1.780" x 0.080" Microstrip | Z10* | 0.366" x 0.170" Microstrip |
| Z3*    | 0.576" x 0.080" Microstrip | Z11* | 2.195" x 0.170" Microstrip |
| Z4     | 0.220" x 0.220" Microstrip | Z12* | 0.614" x 0.170" Microstrip |
| Z5     | 0.322" x 0.220" Microstrip | Z13  | 0.243" x 0.080" Microstrip |
| Z6     | 0.168" x 0.220" Microstrip |      |                            |
| Z7, Z8 | 0.282" x 0.630" Microstrip |      |                            |

\* Line length includes microstrip bends

Note: Same test circuit is used for both pulsed and CW.

**Figure 2. MMRF1310HR5(HSR5) Test Circuit Schematic**

**Table 5. MMRF1310HR5(HSR5) Test Circuit Component Designations and Values**

| Part          | Description                                | Part Number           | Manufacturer |
|---------------|--|-----------------------|--------------|
| C1, C20       | 15 pF Chip Capacitors                      | ATC100B150JT500XT     | ATC          |
| C2            | 82 pF Chip Capacitor                       | ATC100B820JT500XT     | ATC          |
| C3, C17       | 91 pF Chip Capacitors                      | ATC100B910JT500XT     | ATC          |
| C4, C10       | 1000 pF Chip Capacitors                    | ATC100B102JT50XT      | ATC          |
| C5, C11       | 10K pF Chip Capacitors                     | ATC200B103KT50XT      | ATC          |
| C6            | 0.1 $\mu$ F, 50 V Chip Capacitor           | CDR33BX104AKWS        | AVX          |
| C7            | 2.2 $\mu$ F, 100 V Chip Capacitor          | HMK432B7225KM-T       | Taiyo Yuden  |
| C8            | 10 $\mu$ F, 35 V Tantalum Capacitor        | T491D106K035AT        | Kemet        |
| C9            | 2.2 $\mu$ F, 100 V Chip Capacitor          | G2225X7R225KT3AB      | ATC          |
| C12           | 0.1 $\mu$ F, 100 V Chip Capacitor          | C1812F104K1RAC        | Kemet        |
| C13           | 0.01 $\mu$ F, 100 V Chip Capacitor         | C1825C103K1GAC        | Kemet        |
| C14, C15, C16 | 220 $\mu$ F, 100 V Electrolytic Capacitors | MCGPR100V227M16X26-RH | Multicomp    |
| C18, C19      | 18 pF Chip Capacitors                      | ATC100B180JT500XT     | ATC          |
| L1            | 120 nH Inductor                            | 1812SMS-R12JLC        | Coilcraft    |
| L2            | 17.5 nH Inductor                           | GA3095-ALC            | Coilcraft    |
| R1            | 1000 $\Omega$ , 1/2 W Chip Resistor        | CRCW20101K00FKEF      | Vishay       |
| PCB           | 0.030", $\epsilon_r = 2.55$                | AD255A                | Arlon        |

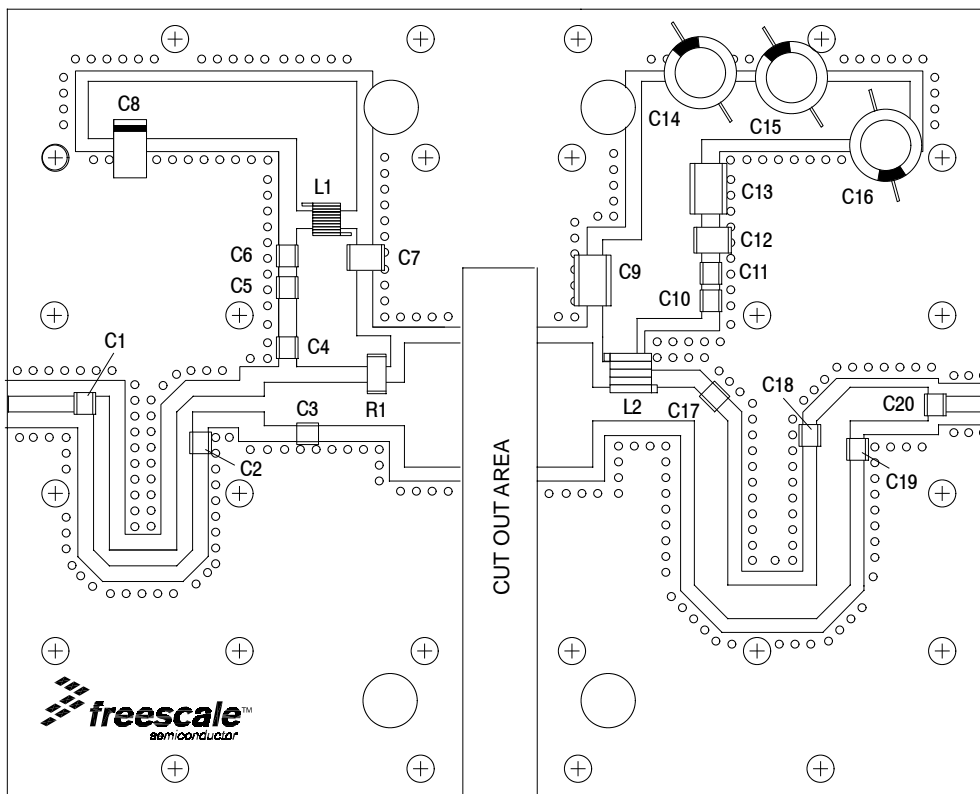
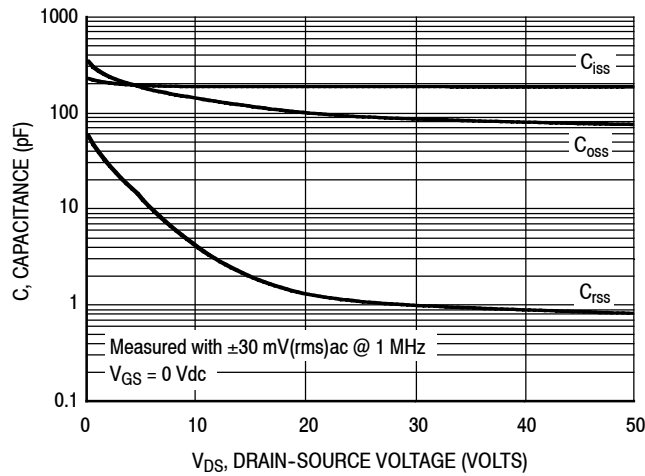

Figure 3. MMRF1310HR5(HSR5) Test Circuit Component Layout

### TYPICAL CHARACTERISTICS — PULSED



Note: Each side of device measured separately.

Figure 4. Capacitance versus Drain-Source Voltage

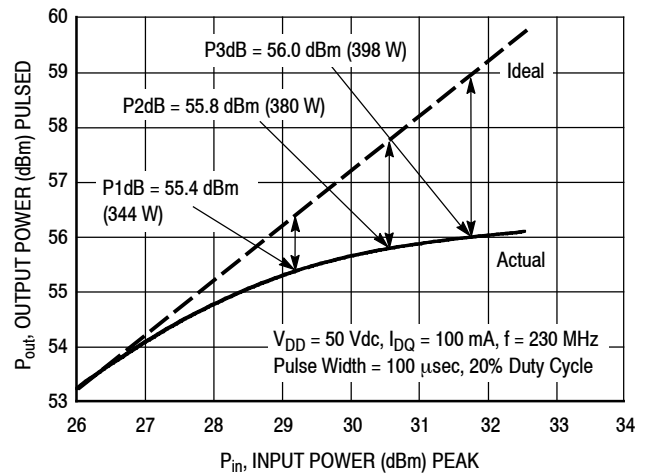

Figure 5. Output Power versus Input Power

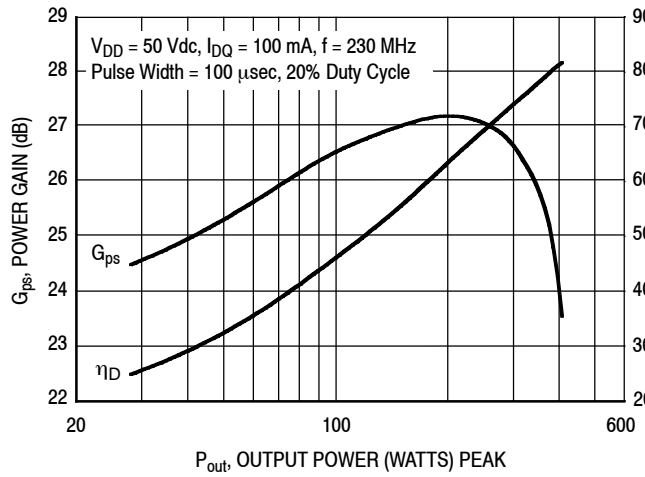

Figure 6. Power Gain and Drain Efficiency versus Output Power

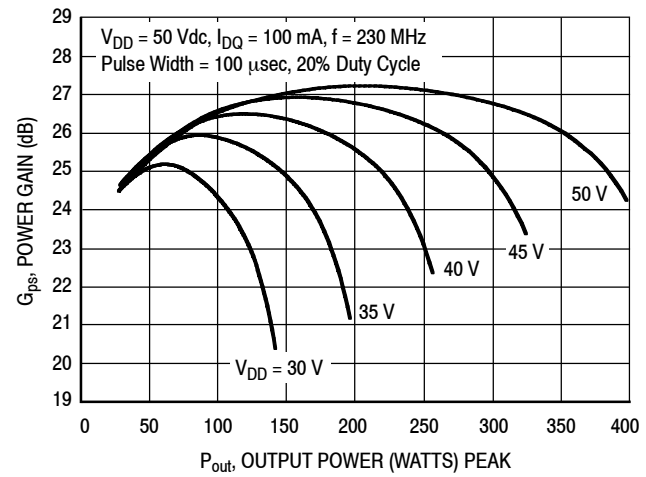

Figure 7. Power Gain versus Output Power

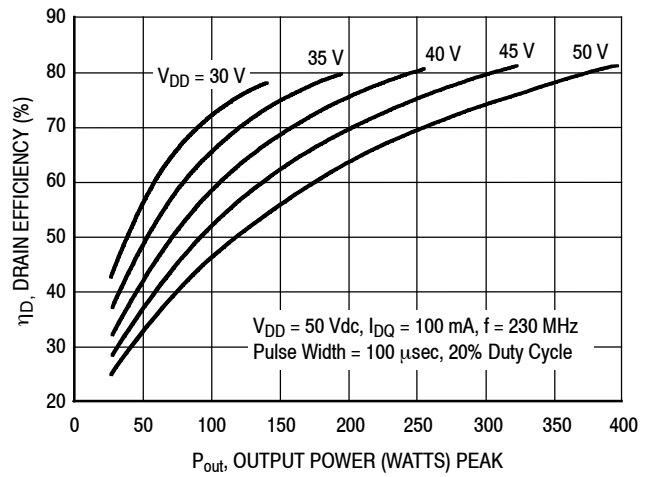

Figure 8. Drain Efficiency versus Output Power

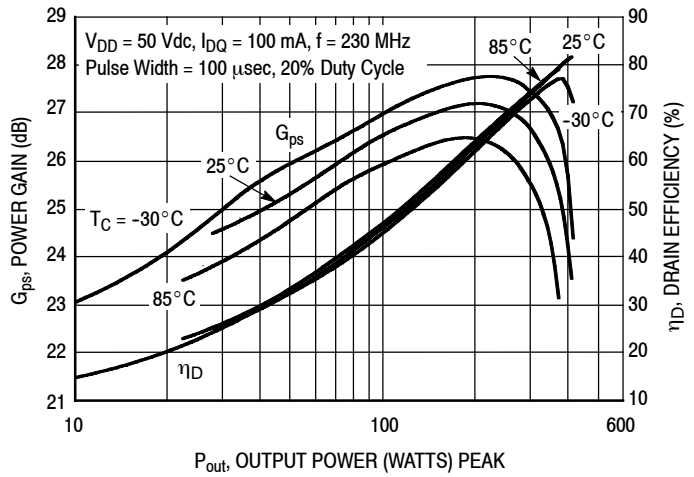
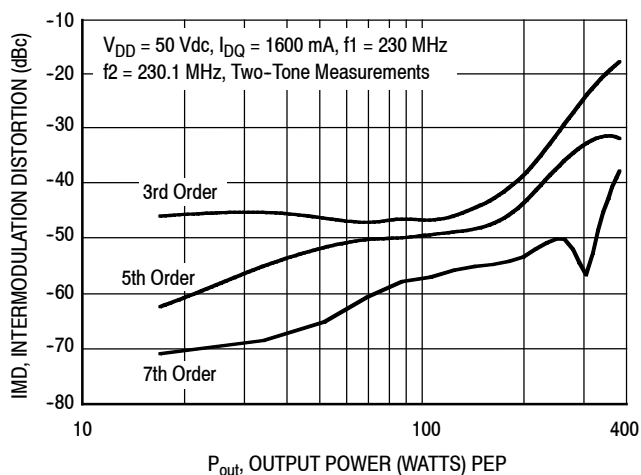
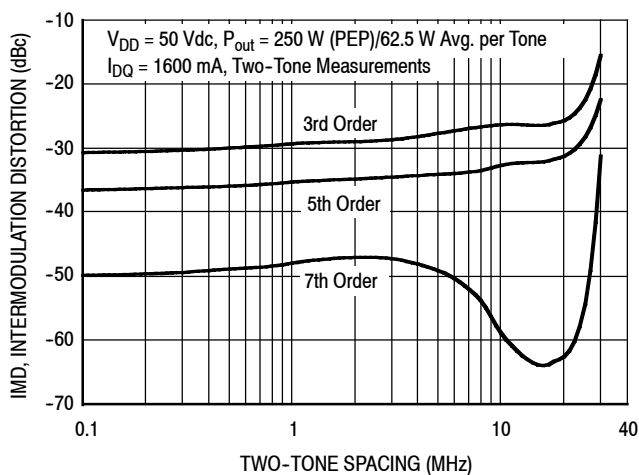

Figure 9. Power Gain and Drain Efficiency versus Output Power

## TYPICAL CHARACTERISTICS — TWO-TONE (1)



**Figure 10. Intermodulation Distortion Products versus Output Power**



**Figure 11. Intermodulation Distortion Products versus Two-Tone Spacing**

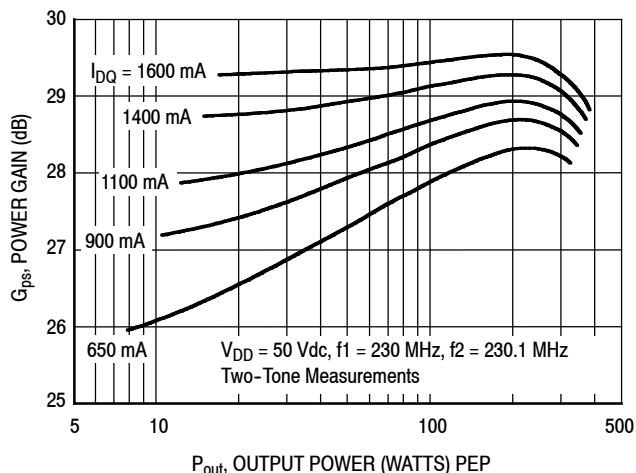

**Figure 12. Two-Tone Power Gain versus Output Power**

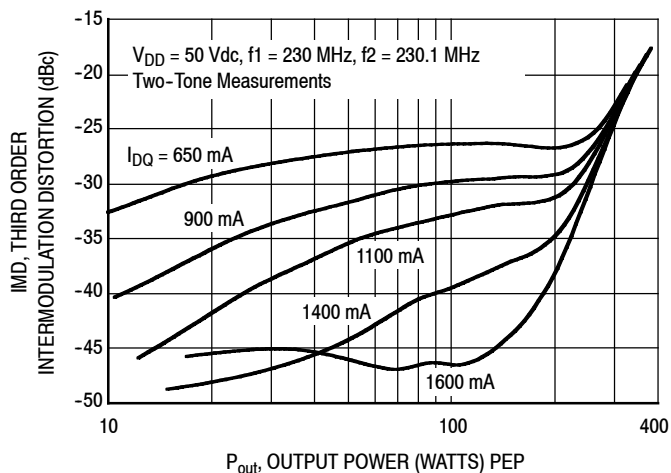

**Figure 13. Third Order Intermodulation Distortion versus Output Power**

1. The distortion products are referenced to one of the two tones and the peak envelope power (PEP) is 6 dB above the power in a single tone.

## TYPICAL CHARACTERISTICS

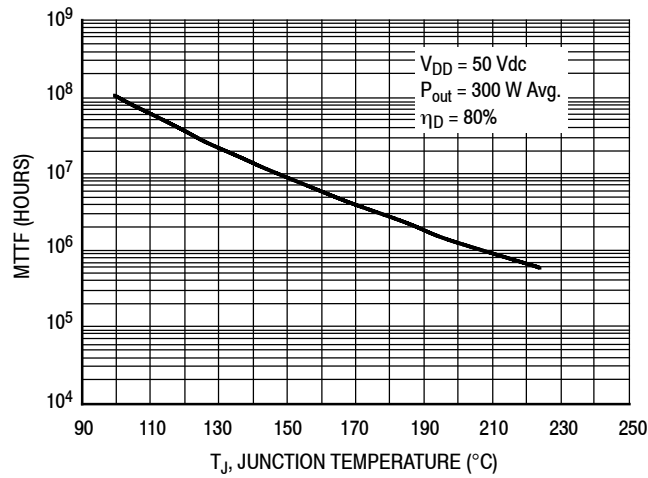

MTTF calculator available at <http://www.freescale.com/rf>. Select Software & Tools/Development Tools/Calculators to access MTTF calculators by product.

**Figure 14. MTTF versus Junction Temperature — CW**

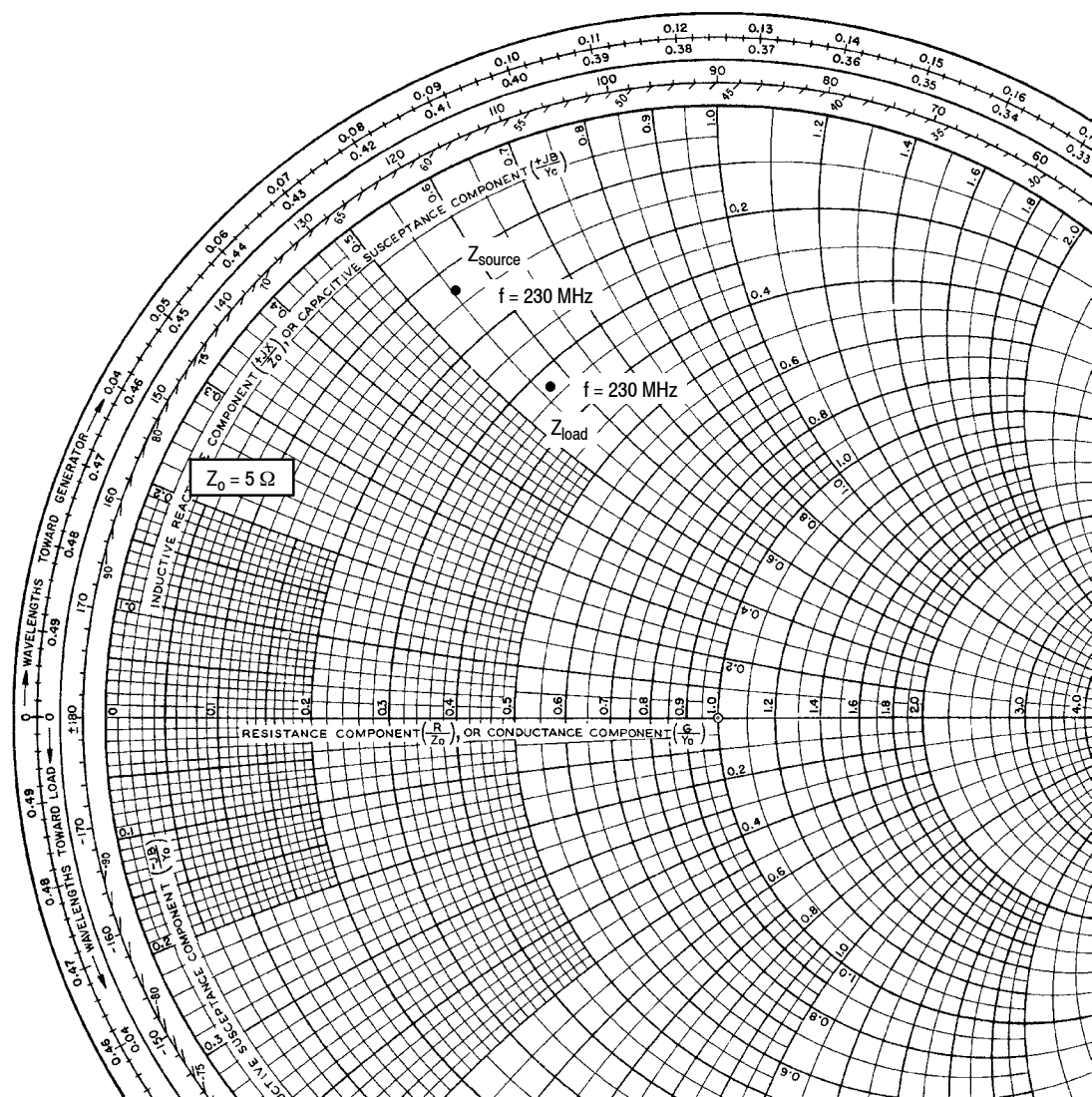

$V_{DD} = 50 \text{ Vdc}$ ,  $I_{DQ} = 100 \text{ mA}$ ,  $P_{out} = 300 \text{ W Peak}$

| f<br>MHz | $Z_{source}$<br>$\Omega$ | $Z_{load}$<br>$\Omega$ |
|----------|--------------------------|------------------------|
| 230      | $0.65 + j2.79$           | $1.64 + j2.85$         |

$Z_{source}$  = Test circuit impedance as measured from gate to ground.

$Z_{load}$  = Test circuit impedance as measured from drain to ground.

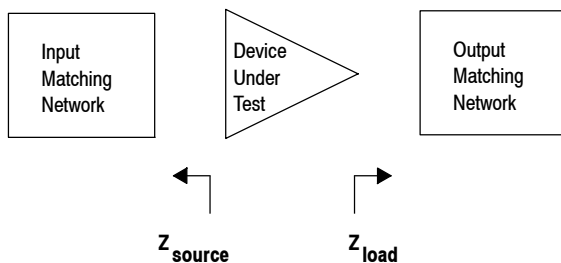

Figure 15. Series Equivalent Source and Load Impedance



$V_{DD} = 50 \text{ Vdc}$ ,  $I_{DQ} = 100 \text{ mA}$

| f<br>MHz | $Z_{\text{source}}$<br>$\Omega$ | $Z_{\text{load}}$<br>$\Omega$ |
|----------|---------------------------------|-------------------------------|
| 10       | $36.0 + j128$                   | $12.0 + j8.80$                |
| 25       | $20.0 + j64.0$                  | $12.4 + j6.40$                |
| 50       | $16.0 + j41.6$                  | $11.6 + j14.4$                |
| 100      | $8.00 + j24.8$                  | $9.00 + j9.80$                |
| 200      | $3.00 + j12.8$                  | $7.20 + j6.40$                |
| 300      | $1.52 + j7.92$                  | $6.00 + j5.00$                |
| 400      | $1.08 + j5.04$                  | $4.20 + j4.00$                |
| 500      | $1.04 + j3.16$                  | $3.32 + j2.72$                |
| 600      | $0.88 + j1.76$                  | $2.72 + j1.68$                |

1. Simulated performance at 1 dB gain compression.

$Z_{\text{source}}$  = Source impedance presented from gate to gate.

$Z_{\text{load}}$  = Load impedance presented from drain to drain.

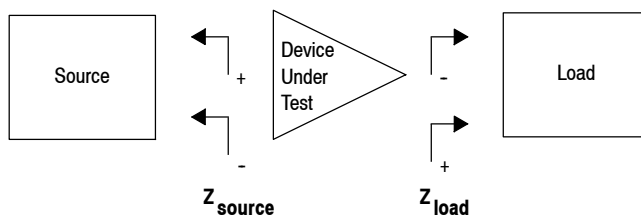

**Figure 16. Simulated Source and Load Impedances Optimized for IRL, Output Power and Drain Efficiency — Push-Pull**

### PACKAGE DIMENSIONS

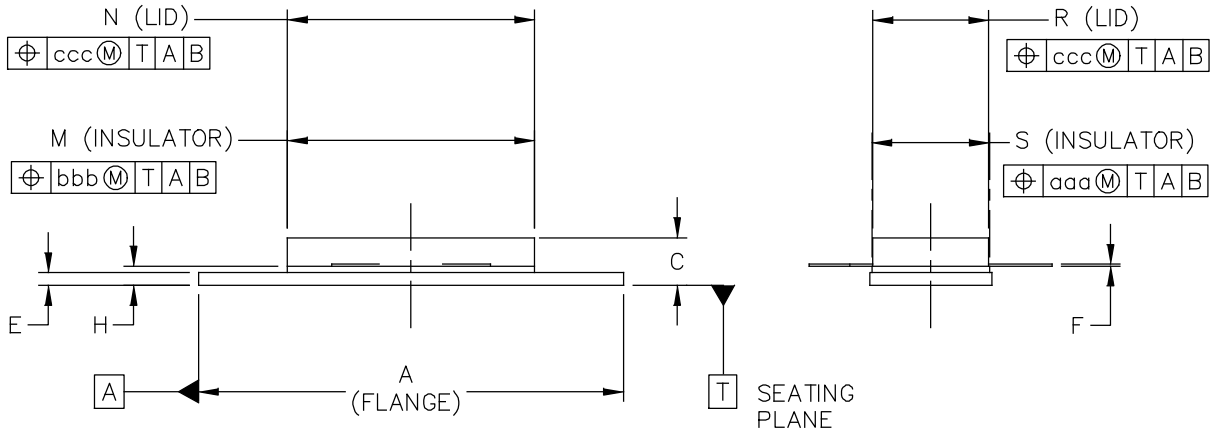
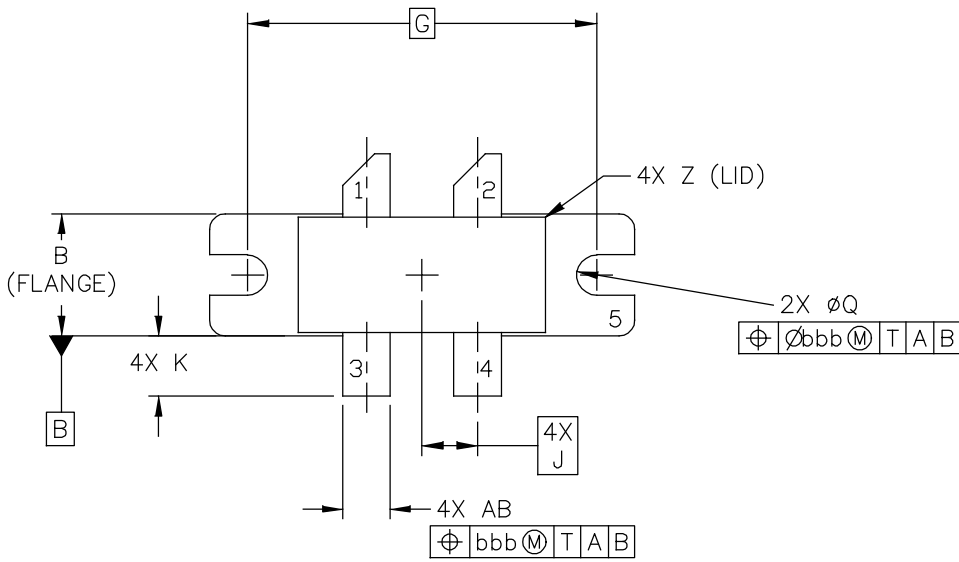

|   |                          |                            |
|---|--------------------------|----------------------------|
| © FREESCALE SEMICONDUCTOR, INC.<br>ALL RIGHTS RESERVED. | MECHANICAL OUTLINE       | PRINT VERSION NOT TO SCALE |
| TITLE:<br><br>NI 780-4                                  | DOCUMENT NO: 98ASA10793D | REV: 0                     |
|   | CASE NUMBER: 465M-01     | 27 MAR 2007                |
|   | STANDARD: NON-JEDEC      |                            |

NOTES:

1. DIMENSIONING AND TOLERANCING PER ANSI Y14.5M-1994.
2. CONTROLLING DIMENSION: INCH.
3. DIMENSION H IS MEASURED .030 (0.762) AWAY FROM PACKAGE BODY.

STYLE 1:

- PIN 1. DRAIN  
 2. DRAIN  
 3. GATE  
 4. GATE  
 5. SOURCE

| DIM   | INCH      |       | MILLIMETER         |       | DIM                      | INCH                       |      | MILLIMETER  |       |
|---|-----------|-------|--------------------|-------|--------------------------|----------------------------|------|-------------|-------|
|   | MIN       | MAX   | MIN                | MAX   |                          | MIN                        | MAX  | MIN         | MAX   |
| A   | 1.335     | 1.345 | 33.91              | 34.16 | R                        | .365                       | .375 | 9.27        | 9.53  |
| B   | .380      | .390  | 9.65               | 9.91  | S                        | .365                       | .375 | 9.27        | 9.52  |
| C   | .125      | .170  | 3.18               | 4.32  | U                        |                            | .040 |             | 1.02  |
| E   | .035      | .045  | 0.89               | 1.14  | Z                        |                            | .030 |             | 0.76  |
| F   | .003      | .006  | 0.08               | 0.15  | AB                       | .145                       | .155 | 3.68        | 3.94  |
| G   | 1.100 BSC |       | 27.94 BSC          |       |                          |                            |      |             |       |
| H   | .057      | .067  | 1.45               | 1.7   | aaa                      |                            | .005 |             | 0.127 |
| J   | .175 BSC  |       | 4.44 BSC           |       | bbb                      |                            | .010 |             | 0.254 |
| K   | .170      | .210  | 4.32               | 5.33  | ccc                      |                            | .015 |             | 0.381 |
| M   | .774      | .786  | 19.61              | 20.02 |                          |                            |      |             |       |
| N   | .772      | .788  | 19.61              | 20.02 |                          |                            |      |             |       |
| Q   | ø.118     | ø.138 | ø3                 | ø3.51 |                          |                            |      |             |       |
| © FREESCALE SEMICONDUCTOR, INC.<br>ALL RIGHTS RESERVED. |           |       | MECHANICAL OUTLINE |       |                          | PRINT VERSION NOT TO SCALE |      |             |       |
| TITLE:<br><br>NI 780-4                                  |           |       |                    |       | DOCUMENT NO: 98ASA10793D |                            |      | REV: 0      |       |
|   |           |       |                    |       | CASE NUMBER: 465M-01     |                            |      | 27 MAR 2007 |       |
|   |           |       |                    |       | STANDARD: NON-JEDEC      |                            |      |             |       |

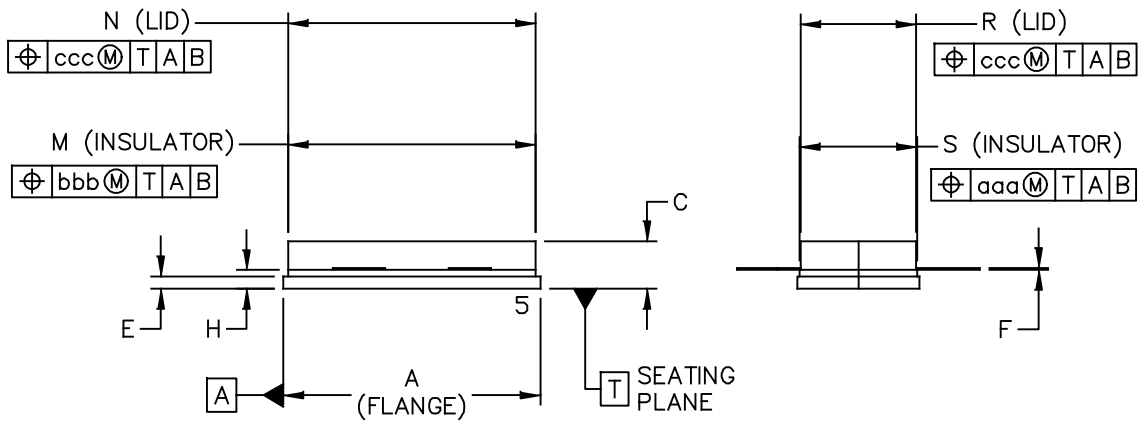
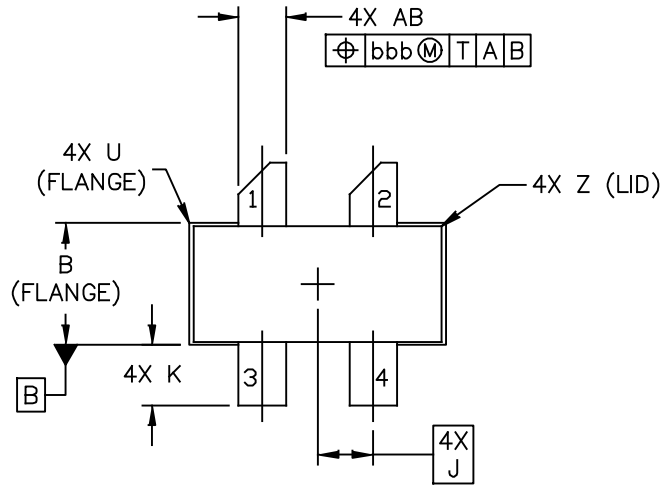

|   |                          |                            |  |
|---|--------------------------|----------------------------|--|
| © FREESCALE SEMICONDUCTOR, INC.<br>ALL RIGHTS RESERVED. | MECHANICAL OUTLINE       | PRINT VERSION NOT TO SCALE |  |
| TITLE:<br><br>NI 780S-4                                 | DOCUMENT NO: 98ASA10718D | REV: A                     |  |
|   | CASE NUMBER: 465H-02     | 27 MAR 2007                |  |
|   | STANDARD: NON-JEDEC      |                            |  |

NOTES:

1. DIMENSIONING AND TOLERANCING PER ANSI Y14.5M-1994.
2. CONTROLLING DIMENSION: INCH.
3. DELETED
4. DIMENSION H IS MEASURED .030 (0.762) AWAY FROM PACKAGE BODY.

STYLE 1:

- PIN 1. DRAIN
- 2. DRAIN
- 3. GATE
- 4. GATE
- 5. SOURCE

| DIM   | INCH     |      | MILLIMETER         |       | DIM                      | INCH                       |      | MILLIMETER  |        |
|---|----------|------|--------------------|-------|--------------------------|----------------------------|------|-------------|--------|
|   | MIN      | MAX  | MIN                | MAX   |                          | MIN                        | MAX  | MIN         | MAX    |
| A   | .805     | .815 | 20.45              | 20.7  | U                        |                            | .040 |             | 1.02   |
| B   | .380     | .390 | 9.65               | 9.91  | Z                        |                            | .030 |             | 0.76   |
| C   | .125     | .170 | 3.18               | 4.32  | AB                       | .145                       | .155 | 3.68        | – 3.94 |
| E   | .035     | .045 | 0.89               | 1.14  |                          |                            |      |             |        |
| F   | .003     | .006 | 0.08               | 0.15  | aaa                      |                            | .005 |             | 0.127  |
| H   | .057     | .067 | 1.45               | 1.7   | bbb                      |                            | .010 |             | 0.254  |
| J   | .175 BSC |      | 4.44 BSC           |       | ccc                      |                            | .015 |             | 0.381  |
| K   | .170     | .210 | 4.32               | 5.33  |                          |                            |      |             |        |
| M   | .774     | .786 | 19.61              | 20.02 |                          |                            |      |             |        |
| N   | .772     | .788 | 19.61              | 20.02 |                          |                            |      |             |        |
| R   | .365     | .375 | 9.27               | 9.53  |                          |                            |      |             |        |
| S   | .365     | .375 | 9.27               | 9.52  |                          |                            |      |             |        |
| © FREESCALE SEMICONDUCTOR, INC.<br>ALL RIGHTS RESERVED. |          |      | MECHANICAL OUTLINE |       |                          | PRINT VERSION NOT TO SCALE |      |             |        |
| TITLE:<br><br>NI 780S-4                                 |          |      |                    |       | DOCUMENT NO: 98ASA10718D |                            |      | REV: A      |        |
|   |          |      |                    |       | CASE NUMBER: 465H-02     |                            |      | 27 MAR 2007 |        |
|   |          |      |                    |       | STANDARD: NON-JEDEC      |                            |      |             |        |

## PRODUCT DOCUMENTATION AND SOFTWARE

Refer to the following resources to aid your design process.

### Application Notes

- AN1955: Thermal Measurement Methodology of RF Power Amplifiers

### Engineering Bulletins

- EB212: Using Data Sheet Impedances for RF LDMOS Devices

### Software

- Electromigration MTTF Calculator

For Software, do a Part Number search at <http://www.freescale.com>, and select the “Part Number” link. Go to the Software & Tools tab on the part’s Product Summary page to download the respective tool.

## REVISION HISTORY

The following table summarizes revisions to this document.

| Revision | Date      | Description                     |
|----------|-----------|---------------------------------|
| 0        | July 2014 | • Initial Release of Data Sheet |

### ***How to Reach Us:***

**Home Page:**  
[freescale.com](http://freescale.com)

**Web Support:**  
[freescale.com/support](http://freescale.com/support)

Information in this document is provided solely to enable system and software implementers to use Freescale products. There are no express or implied copyright licenses granted hereunder to design or fabricate any integrated circuits based on the information in this document.

Freescale reserves the right to make changes without further notice to any products herein. Freescale makes no warranty, representation, or guarantee regarding the suitability of its products for any particular purpose, nor does Freescale assume any liability arising out of the application or use of any product or circuit, and specifically disclaims any and all liability, including without limitation consequential or incidental damages. "Typical" parameters that may be provided in Freescale data sheets and/or specifications can and do vary in different applications, and actual performance may vary over time. All operating parameters, including "typicals," must be validated for each customer application by customer's technical experts. Freescale does not convey any license under its patent rights nor the rights of others. Freescale sells products pursuant to standard terms and conditions of sale, which can be found at the following address: [freescale.com/SalesTermsandConditions](http://freescale.com/SalesTermsandConditions).

Freescale and the Freescale logo are trademarks of Freescale Semiconductor, Inc., Reg. U.S. Pat. & Tm. Off. All other product or service names are the property of their respective owners.

© 2014 Freescale Semiconductor, Inc.