

FEATURES

Passive, wideband I/Q mixer
RF and LO range: 20 GHz to 42 GHz
Wide IF bandwidth of dc to 5 GHz
Single-ended RF, LO, and IF
Conversion loss: 10 dB typical, from 20 GHz to 32 GHz
Image rejection: 25 dB typical, from 20 GHz to 32 GHz
Noise figure: 12 dB typical, from 20 GHz to 32 GHz
Input IP3 (downconverter): 24 dBm typical, from 20 GHz to 32 GHz
Input P1dB (downconverter) compression: 15 dBm typical, from 20 GHz to 32 GHz
Input IP2: 56 dB typical, from 20 GHz to 32 GHz
LO to RF isolation: 42 dB typical, from 20 GHz to 32 GHz
LO to IFx isolation: 51 dB typical, from 20 GHz to 32 GHz
RF to IF isolation: 30 dB typical, from 20 GHz to 32 GHz
Amplitude balance: ± 3 dB typical
Phase balance (downconverter): $\pm 11^\circ$ typical
RF return loss: 14 dB typical
LO return loss: 11 dB typical
IFx return loss: 20 dB typical
Die size: 2.160 mm \times 1.430 mm \times 0.102 mm

APPLICATIONS

Test and measurement instrumentation
Military, radar, aerospace, and defense applications
Microwave point to point base stations

GENERAL DESCRIPTION

The HMC8192-Die is a passive, wideband, inphase/quadrature (I/Q), monolithic microwave integrated circuit (MMIC) mixer that can be used either as an image rejection mixer for receiver operations or as a single-sideband upconverter for transmitter operations. With a radio frequency (RF) and local oscillator (LO) range of 20 GHz to 42 GHz, and an intermediate frequency (IF) bandwidth of dc to 5 GHz, the HMC8192-Die is ideal for applications requiring a wide frequency range, excellent RF performance, and a simple design with fewer components. A single HMC8192-Die can replace multiple narrow-band mixers in a design.

The inherent I/Q architecture of the HMC8192-Die offers excellent image rejection, typically better than 25 dBc,

FUNCTIONAL BLOCK DIAGRAM

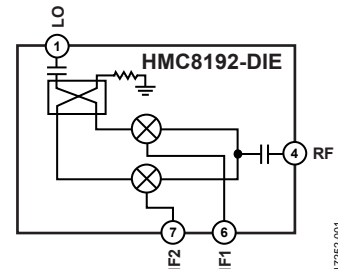

Figure 1.

17252-001

eliminating the need for additional filtering of unwanted sidebands. The mixer also provides excellent LO to RF and LO to IFx isolation of 42 dB and 51 dB, respectively, from 20 GHz to 32 GHz, and reduces the effect of LO leakage to ensure signal integrity.

As a passive mixer, the HMC8192-Die does not require any dc power sources. The HMC8192-Die offers a lower noise figure compared to an active mixer, ensuring superior dynamic range for high performance and precision applications.

The HMC8192-Die is fabricated on a gallium arsenide (GaAs), metal semiconductor field effect transistor (MESFET) process and uses Analog Devices, Inc., mixer cells and a 90° hybrid. The HMC8192-Die operates over a -55°C to $+85^\circ\text{C}$ temperature range.

TABLE OF CONTENTS

Features	1	Isolation and Return Loss Without External 90° Hybrid at the IFx Ports	11
Applications	1	IF Bandwidth Performance	13
Functional Block Diagram	1	Amplitude and Phase Imbalance Performance: Downconverter, Upper Sideband (Low-Side LO)	15
General Description	1	Spurious and Harmonics Performance	16
Revision History	2	Theory of Operation	18
Specifications	3	Applications Information	19
20 GHz to 32 GHz	3	Mounting and Bonding Techniques for Millimeter Wave GaAs MMiCs	20
32 GHz to 42 GHz	4	Handling Precautions	20
Absolute Maximum Ratings	5	Mounting	20
Thermal Resistance	5	Wire Bonding	20
ESD Caution	5	Outline Dimensions	21
Pin Configuration and Function Descriptions	6	Ordering Guide	21
Interface Schematics	6		
Typical Performance Characteristics	7		
Downconverter Performance	7		
Upconverter Performance	9		

REVISION HISTORY

3/2019—Revision 0: Initial Version

SPECIFICATIONS

20 GHz TO 32 GHz

$T_A = 25^\circ\text{C}$, IF = 100 MHz, LO drive = 18 dBm, all measurements performed as a downconverter with upper sideband selected, external 90° hybrid at the IFx ports, and LO amplifier in line with lab bench LO source, unless otherwise noted.

Table 1.

Parameter	Symbol	Min	Typ	Max	Unit
FREQUENCY					
Radio	RF	20		32	GHz
LO	f_{LO}	20		32	GHz
Intermediate	IF	DC		5	GHz
LO DRIVE LEVEL		16	18	20	dBm
RF PERFORMANCE AS DOWNCONVERTER					
Conversion Loss			10	12	dB
Image Rejection		15	25		dBc
Single-Sideband Noise Figure	SSB NF		12		dB
Input Third-Order Intercept	IP3	22	24		dBm
Input 1 dB Compression Point	P1dB		15		dBm
Input Second-Order Intercept	IP2		56		dBm
Amplitude Balance ¹			± 3		dB
Phase Balance ¹			± 11		Degrees
RF PERFORMANCE AS UPCONVERTER					
Conversion Loss			7		dB
Sideband Rejection			19		dBc
Input Third-Order Intercept	IP3		21		dBm
Input 1 dB Compression Point	P1dB		13		dBm
ISOLATION PERFORMANCE					
LO to RF		36	42		dB
LO to IFx ¹			51		dB
RF to IF ¹			30		dB
RETURN LOSS PERFORMANCE¹					
RF			14		dB
LO			11		dB
IFx			20		dB

¹ Measurements taken without 90° hybrid at the IFx ports.

32 GHz TO 42 GHz

$T_A = 25^\circ\text{C}$, IF = 100 MHz, LO drive = 18 dBm, all measurements performed as downconverter with upper sideband selected, external 90° hybrid at the IFx ports, and LO amplifier in line with lab bench LO source, unless otherwise noted.

Table 2.

Parameter	Symbol	Min	Typ	Max	Unit
FREQUENCY					
Radio	RF	32		42	GHz
LO	f_{LO}	32		42	GHz
Intermediate	IF	DC		5	GHz
LO DRIVE LEVEL					
		16	18	20	dBm
RF PERFORMANCE AS DOWNCONVERTER					
Conversion Loss			13	15.5	dB
Image Rejection		12	18		dBc
Single-Sideband Noise Figure	SSB NF		16		dB
Input Third-Order Intercept	IP3	17	24		dBm
Input 1 dB Compression Point	P1dB		16		dBm
Input Second-Order Intercept	IP2		46		dBm
Amplitude Balance ¹			± 3		dB
Phase Balance ¹			± 11		Degrees
RF PERFORMANCE AS UPCONVERTER					
Conversion Loss			8		dB
Sideband Rejection			15		dBc
Input Third-Order Intercept	IP3		17		dBm
Input 1 dB Compression Point	P1dB		12		dBm
ISOLATION PERFORMANCE					
LO to RF		34	41		dB
LO to IFx ¹			55		dB
RF to IF ¹			34		dB
RETURN LOSS PERFORMANCE¹					
RF			14		dB
LO			11		dB
IFx			20		dB

¹ Measurements taken without 90° hybrid at the IFx ports.

ABSOLUTE MAXIMUM RATINGS

Table 3.

Parameter	Rating
RF Input Power	23 dBm
LO Input Power	23 dBm
IF Input Power	23 dBm
IF Source or Sink Current	3 mA
Continuous Power Dissipation, P_{DISS} ($T_A = 85^\circ\text{C}$, Derate 7.2 mW/ $^\circ\text{C}$ Above 85°C) ¹	647 mW
Maximum Junction Temperature (T_J)	175 $^\circ\text{C}$
Operating Temperature Range	-55 $^\circ\text{C}$ to +85 $^\circ\text{C}$
Storage Temperature Range	-65 $^\circ\text{C}$ to +150 $^\circ\text{C}$
Electrostatic Discharge Sensitivity	
Human Body Model	4000 V
Field Induced Charged Device Model	1250 V

¹ P_{DISS} is a theoretical number calculated by $(T_J - 85^\circ\text{C})/\theta_{JC}$.

Stresses at or above those listed under Absolute Maximum Ratings may cause permanent damage to the product. This is a stress rating only; functional operation of the product at these or any other conditions above those indicated in the operational section of this specification is not implied. Operation beyond the maximum operating conditions for extended periods may affect product reliability.

THERMAL RESISTANCE

Thermal performance is directly linked to printed circuit board (PCB) design and operating environment. Careful attention to PCB thermal design is required.

θ_{JC} is the junction to case thermal resistance.

Table 4. Thermal Resistance

Package Type	θ_{JC}	Unit
C-7-6	139	$^\circ\text{C}/\text{W}$

ESD CAUTION



ESD (electrostatic discharge) sensitive device. Charged devices and circuit boards can discharge without detection. Although this product features patented or proprietary protection circuitry, damage may occur on devices subjected to high energy ESD. Therefore, proper ESD precautions should be taken to avoid performance degradation or loss of functionality.

PIN CONFIGURATION AND FUNCTION DESCRIPTIONS

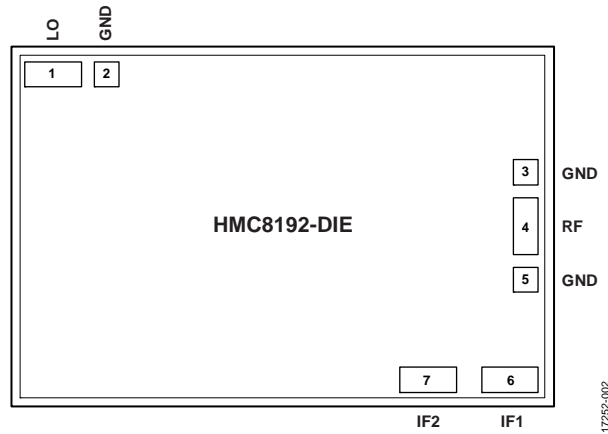

Figure 2. Pin Configuration

Table 5. Pin Function Descriptions

Pin No.	Mnemonic	Description
1	LO	LO Input. This pin is ac-coupled and matched to 50 Ω. See Figure 3 for the interface schematic.
2, 3, 5, Die Bottom	GND	Ground Connections. These pins and the die bottom must be connected to RF and dc ground. See Figure 4 for the interface schematic.
4	RF	RF Input/Output. This pin is ac-coupled and matched to 50 Ω. See Figure 5 for the interface schematic.
6, 7	IF1, IF2	First and Second Quadrature IF Input/Output Pins. These pins are dc-coupled. For applications not requiring operation to dc, use an off-chip dc blocking capacitor. For operations to dc, these pins must not source or sink more than 3 mA of current. Otherwise, the device may not function and may fail. See Figure 6 for the interface schematic.

INTERFACE SCHEMATICS

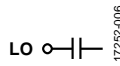

Figure 3. LO Interface Schematic

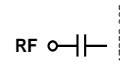

Figure 5. RF Interface Schematic



Figure 4. GND Interface Schematic

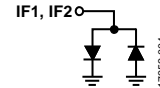

Figure 6. IF1 and IF2 Interface Schematic

TYPICAL PERFORMANCE CHARACTERISTICS

DOWNCONVERTER PERFORMANCE

IF = 100 MHz, Upper Sideband (Low-Side LO)

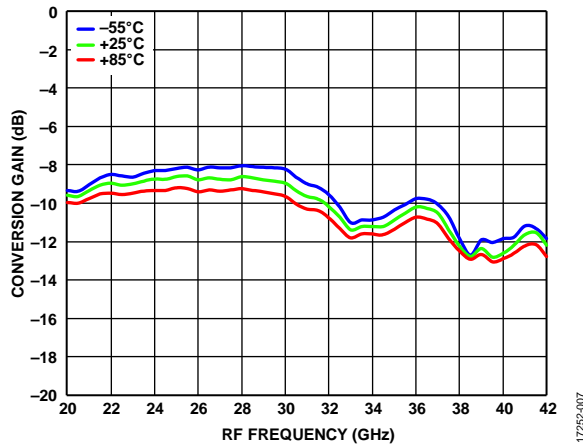

Figure 7. Conversion Gain vs. RF Frequency at Various Temperatures, LO Drive = 18 dBm

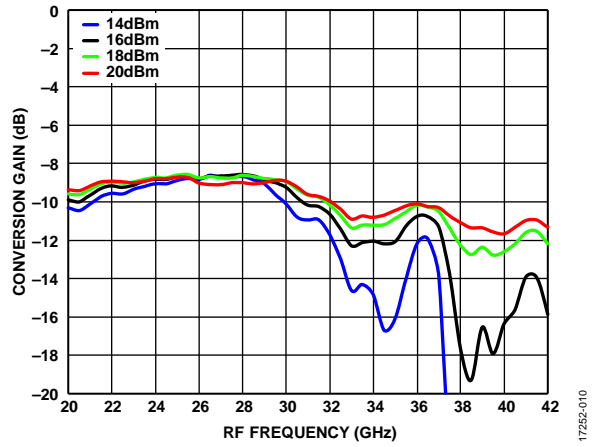

Figure 10. Conversion Gain vs. RF Frequency at Various LO Drives, $T_A = 25^\circ\text{C}$

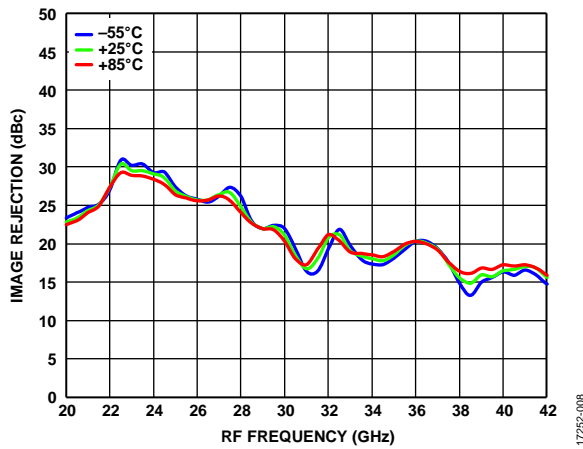

Figure 8. Image Rejection vs. RF Frequency at Various Temperatures, LO Drive = 18 dBm

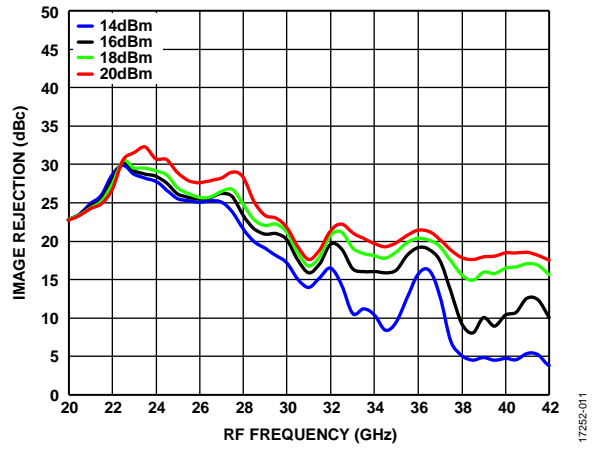

Figure 11. Image Rejection vs. RF Frequency at Various LO Drives, $T_A = 25^\circ\text{C}$

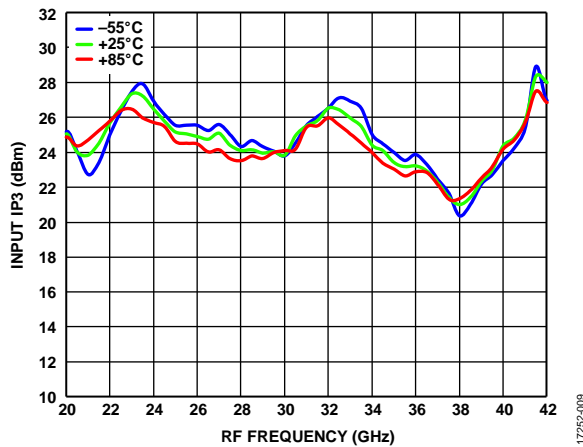

Figure 9. Input IP3 vs. RF Frequency at Various Temperatures, LO Drive = 18 dBm

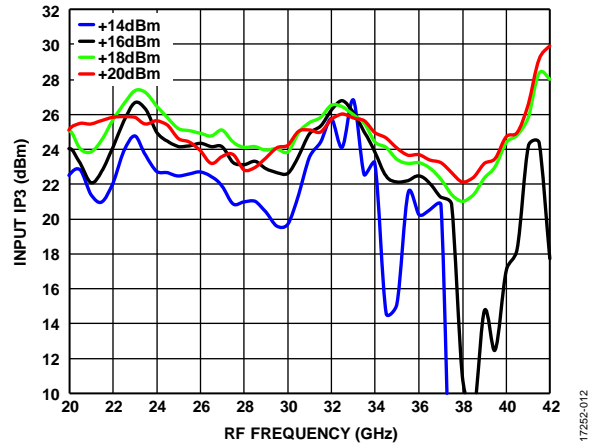

Figure 12. Input IP3 vs. RF Frequency at Various LO Drives, $T_A = 25^\circ\text{C}$

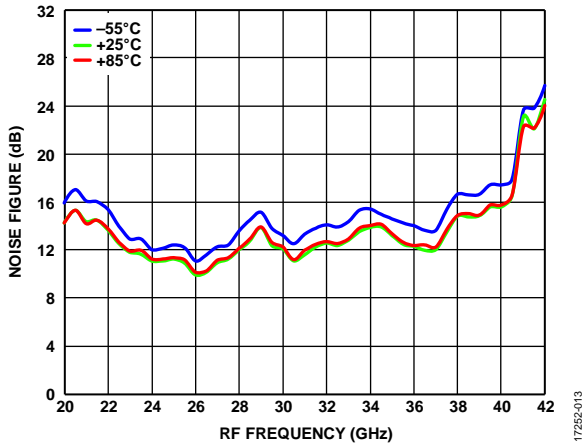

Figure 13. Noise Figure vs. RF Frequency at Various Temperatures, LO Drive = 18 dBm

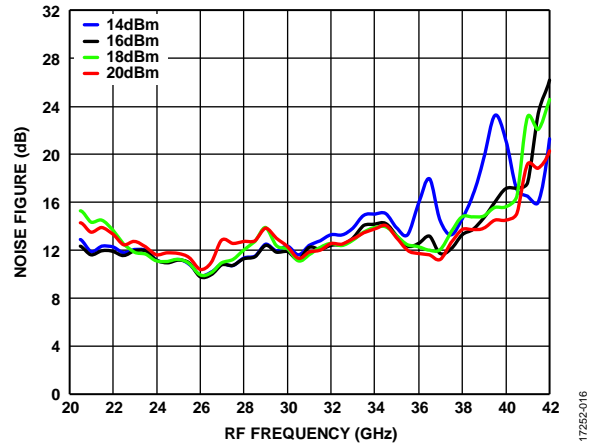

Figure 16. Noise Figure vs. RF Frequency at Various LO Drives, $T_A = 25^\circ\text{C}$

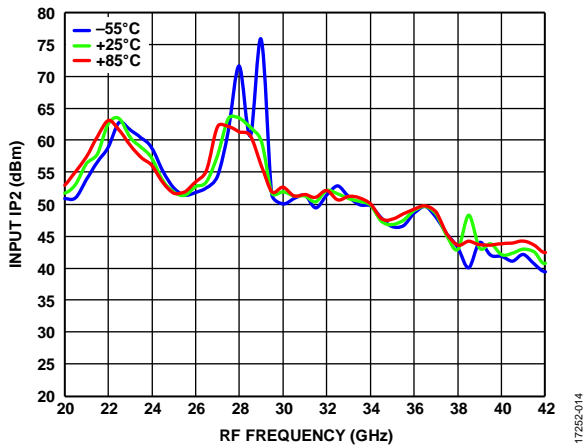

Figure 14. Input IP2 vs. RF Frequency at Various Temperatures, LO Drive = 18 dBm

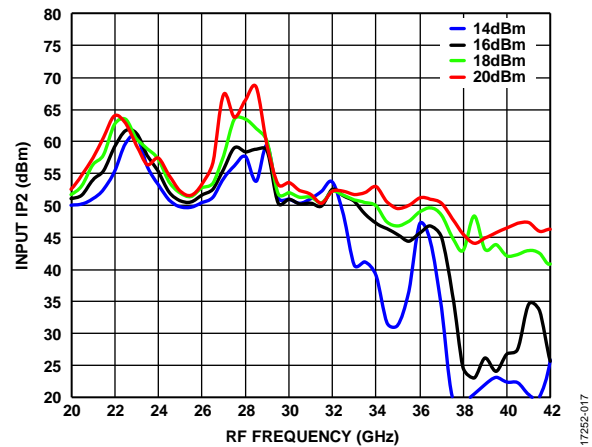

Figure 17. Input IP2 vs. RF Frequency at Various LO Drives, $T_A = 25^\circ\text{C}$

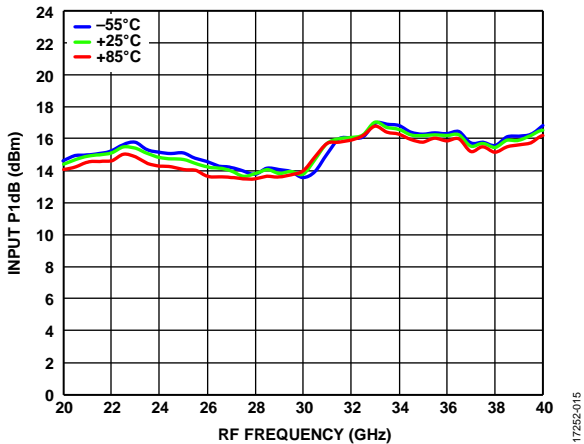

Figure 15. Input P1dB vs. RF Frequency at Various Temperatures, LO Drive = 18 dBm

UPCONVERTER PERFORMANCE

IF = 100 MHz, Upper Sideband

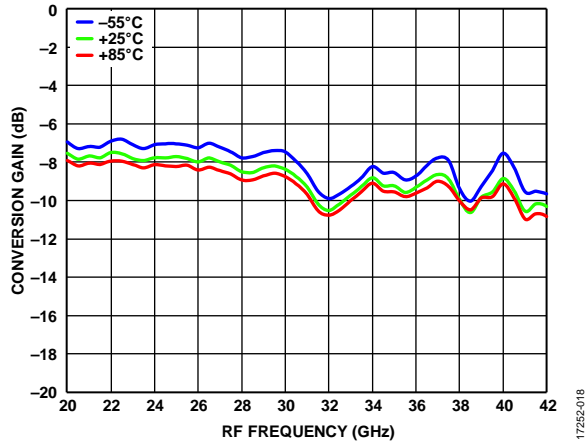

Figure 18. Conversion Gain vs. RF Frequency at Various Temperatures, LO Drive = 18 dBm

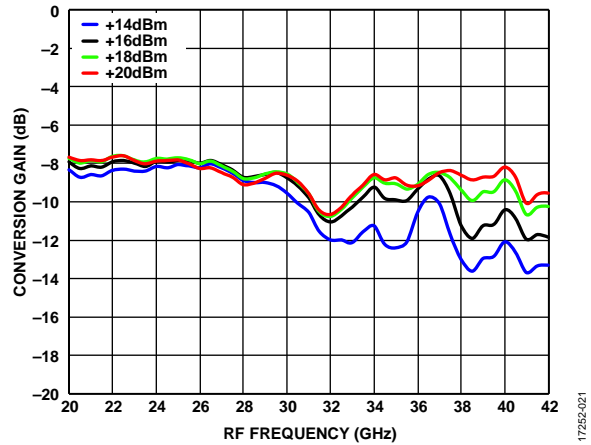

Figure 21. Conversion Gain vs. RF Frequency at Various LO Drives, $T_A = 25^\circ\text{C}$

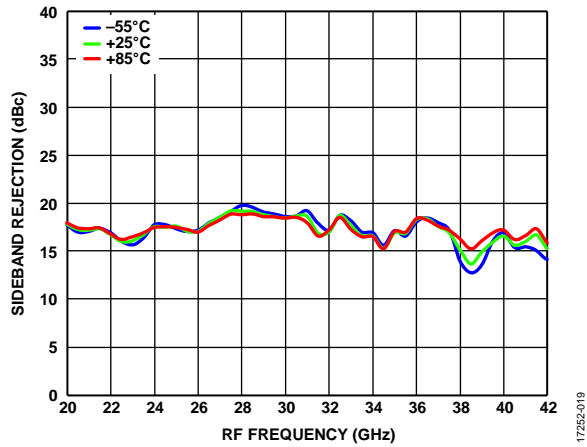

Figure 19. Sideband Rejection vs. RF Frequency at Various Temperatures, LO Drive = 18 dBm

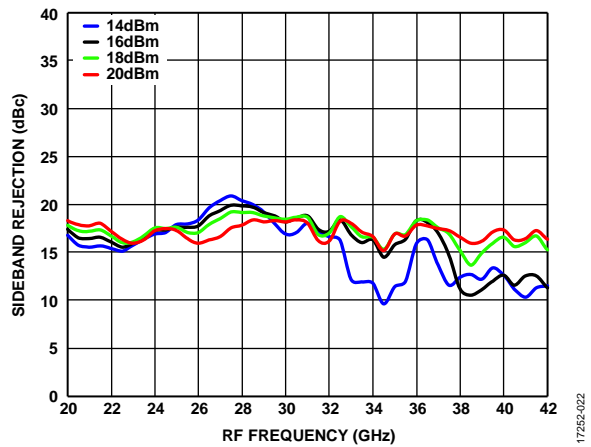

Figure 22. Sideband Rejection vs. RF Frequency at Various LO Drives, $T_A = 25^\circ\text{C}$

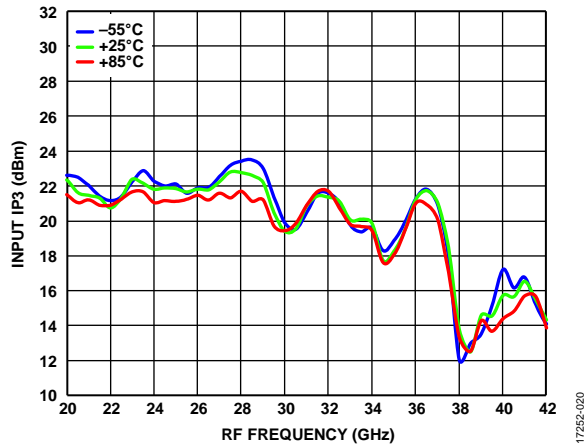

Figure 20. Input IP3 vs. RF Frequency at Various Temperatures, LO Drive = 18 dBm

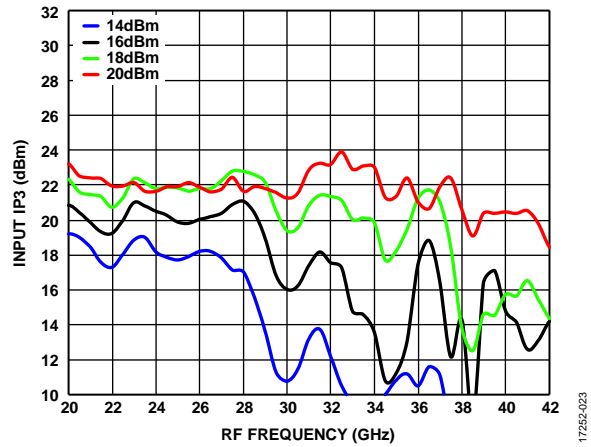

Figure 23. Input IP3 vs. RF Frequency at Various LO Drives, $T_A = 25^\circ\text{C}$

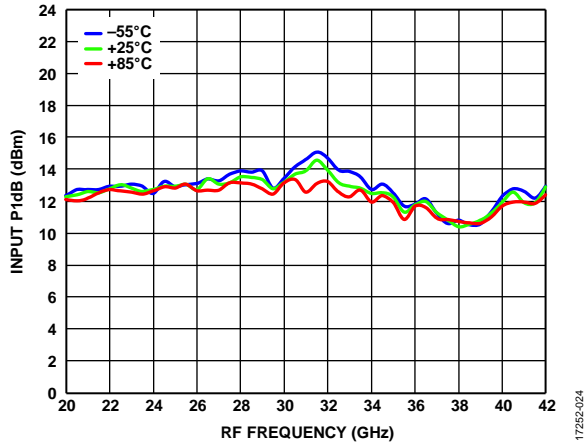

Figure 24. Input P1dB vs. RF Frequency at Various Temperatures, LO Drive = 18 dBm

17262-024

ISOLATION AND RETURN LOSS WITHOUT EXTERNAL 90° HYBRID AT THE IF_x PORTS

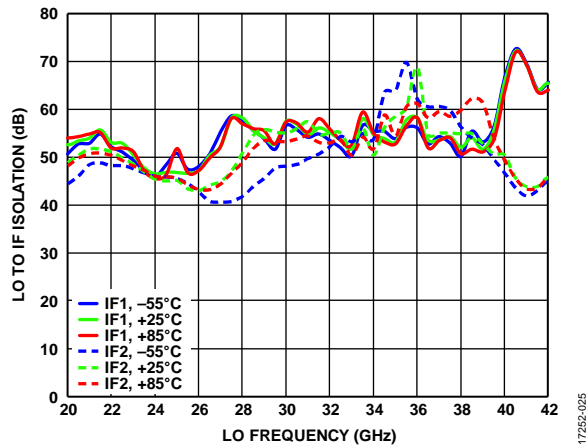

Figure 25. LO to IF Isolation vs. LO Frequency at Various Temperatures, IF = 100 MHz, LO Drive = 18 dBm

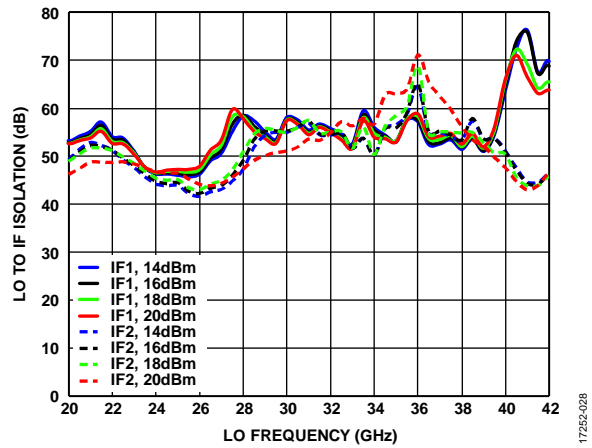

Figure 28. LO to IF Isolation vs. LO Frequency at Various LO Drives, IF = 100 MHz, T_A = 25°C

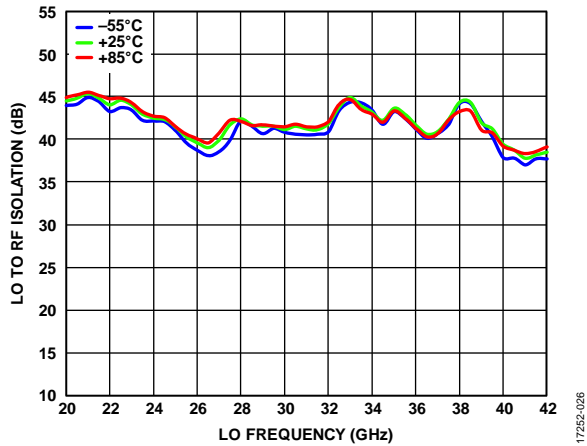

Figure 26. LO to RF Isolation vs. LO Frequency at Various Temperatures, IF = 100 MHz, LO Drive = 18 dBm

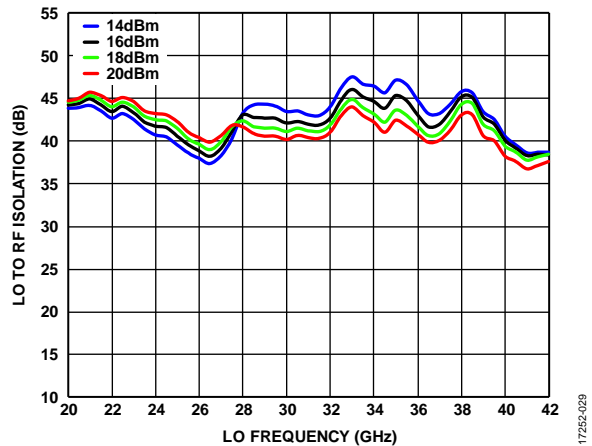

Figure 29. LO to RF Isolation vs. LO Frequency at Various LO Drives, IF = 100 MHz, T_A = 25°C

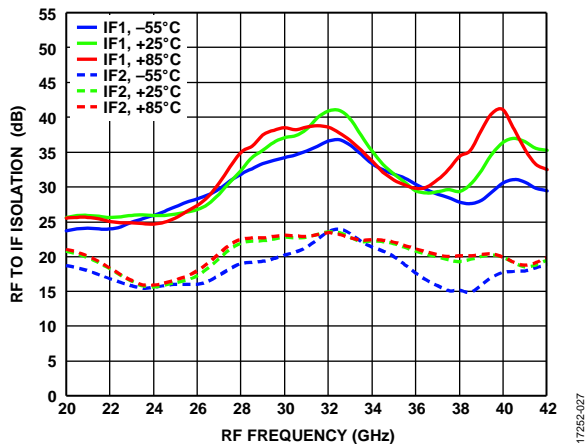

Figure 27. RF to IF Isolation vs. RF Frequency at Various Temperatures, LO Drive = 18 dBm

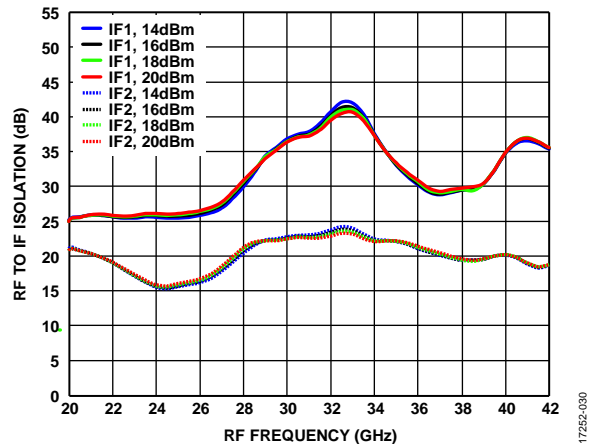

Figure 30. RF to IF Isolation vs. RF Frequency at Various LO Drives, T_A = 25°C

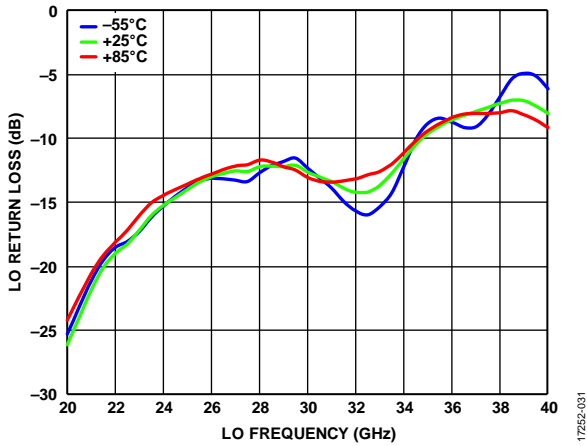

Figure 31. LO Return Loss vs. LO Frequency at Various Temperatures, LO Drive = 18 dBm

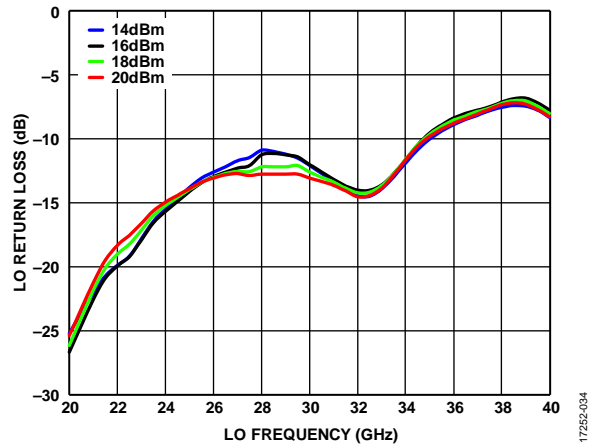

Figure 34. LO Return Loss vs. LO Frequency at Various LO Drives

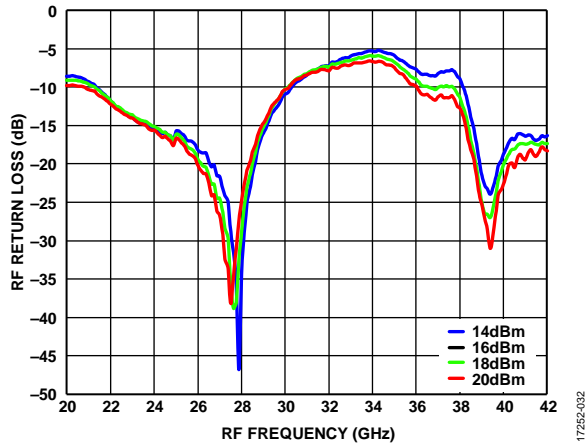

Figure 32. RF Return Loss vs. RF Frequency at Various Temperatures, LO Frequency = 32 GHz, LO Drive = 18 dBm

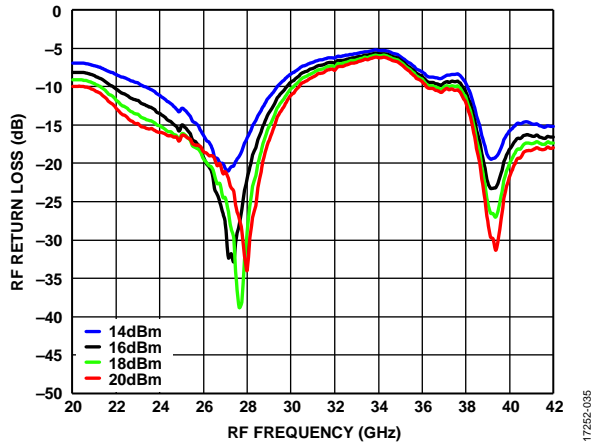

Figure 35. RF Return Loss vs. RF Frequency at Various LO Drives, LO Frequency = 32 GHz

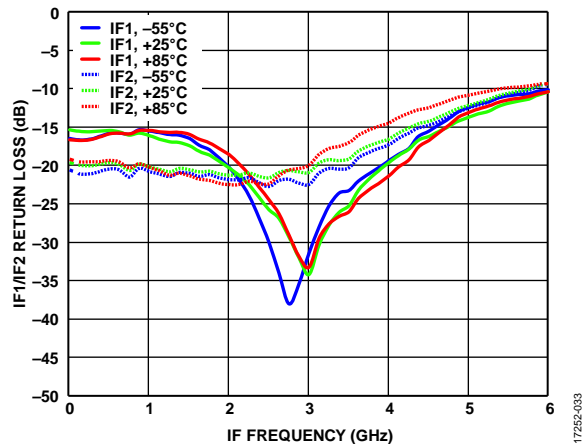

Figure 33. IF1/IF2 Return Loss vs. IF Frequency at Various Temperatures, LO Frequency = 32 GHz, LO Drive = 18 dBm

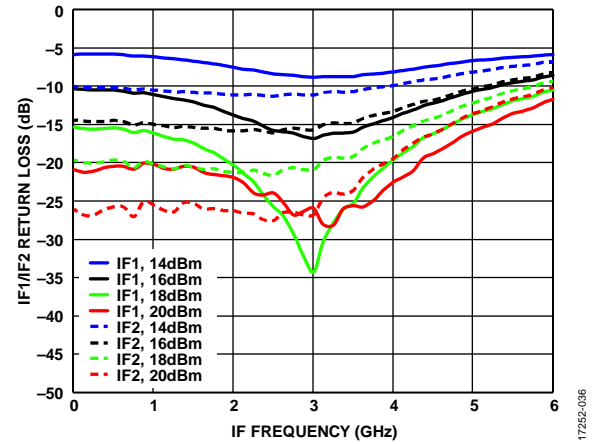

Figure 36. IF1/IF2 Return Loss vs. IF Frequency at Various LO Drives, LO Frequency = 32 GHz

IF BANDWIDTH PERFORMANCE

Downconverter, Upper Sideband (Low-Side LO)

Data over the IF frequency was taken without an external 90° hybrid at the IFx ports.

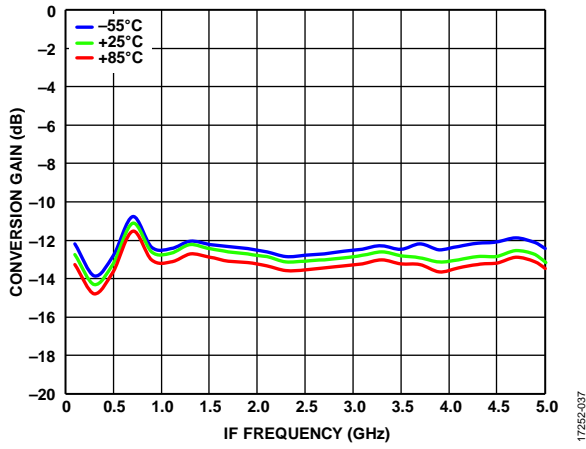

Figure 37. Conversion Gain vs. IF Frequency at Various Temperatures, LO Drive = 18 dBm at 32 GHz

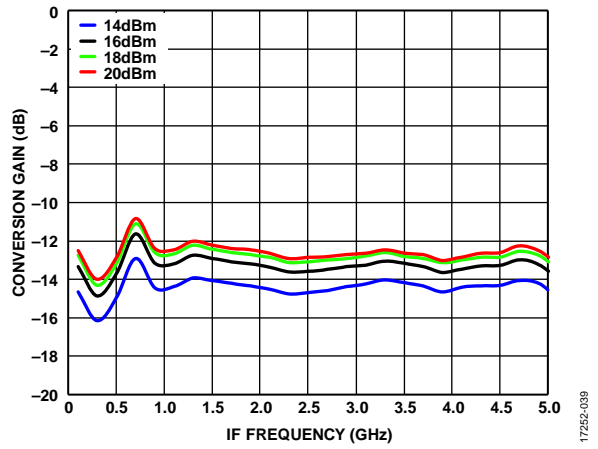

Figure 39. Conversion Gain vs. IF Frequency at Various LO Drives, LO Frequency = 32 GHz, T_A = 25°C

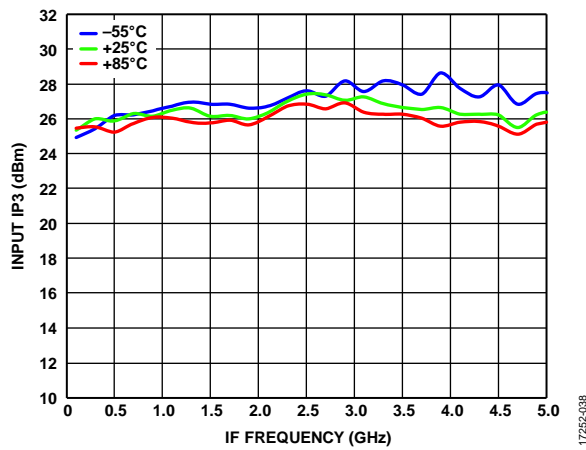

Figure 38. Input IP3 vs. IF Frequency at Various Temperatures, LO Drive = 18 dBm at 32 GHz

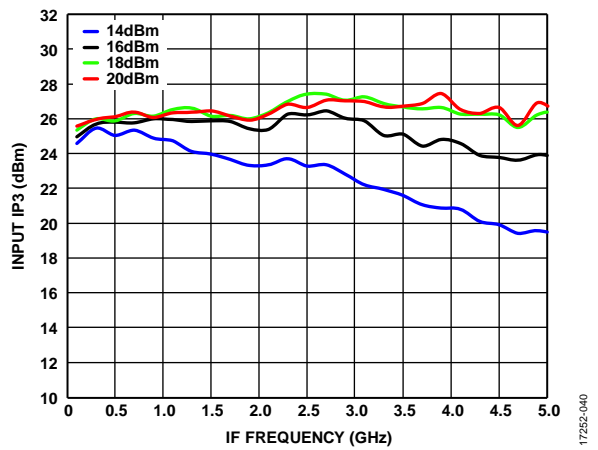

Figure 40. Input IP3 vs. IF Frequency at Various LO Drives, LO Frequency = 32 GHz, T_A = 25°C

Downconverter, Lower Sideband (High-Side LO)

Data over the IF frequency was taken without an external 90° hybrid at the IFx ports.

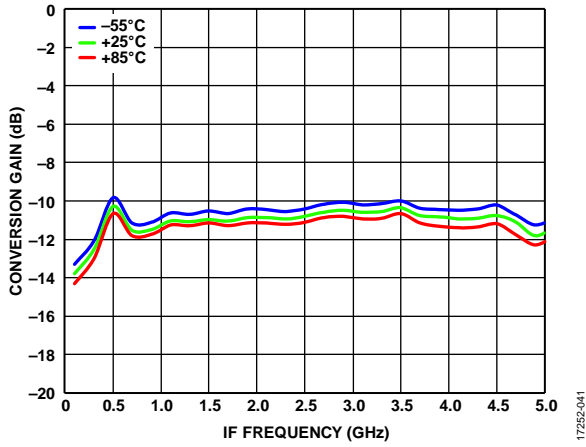

Figure 41. Conversion Gain vs. IF Frequency at Various Temperatures, LO Drive = 18 dBm at 32 GHz

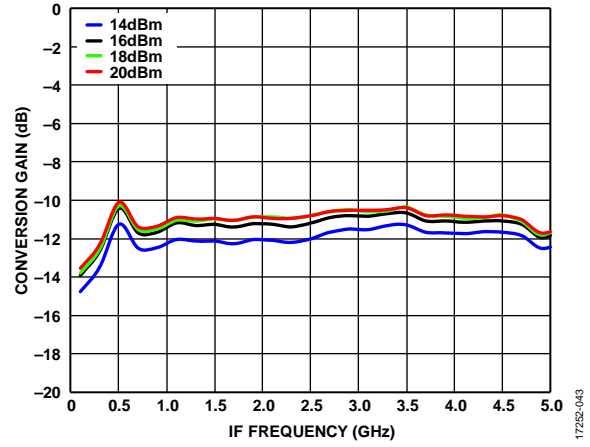

Figure 43. Conversion Gain vs. IF Frequency at Various LO Drives, LO Frequency = 32 GHz, T_A = 25°C

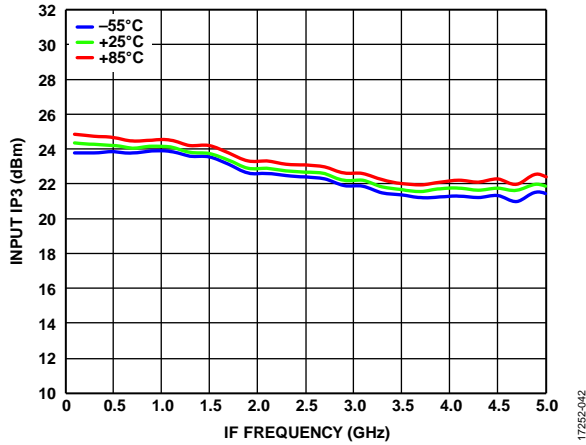

Figure 42. Input IP3 vs. IF Frequency at Various Temperatures, LO Drive = 18 dBm at 32 GHz

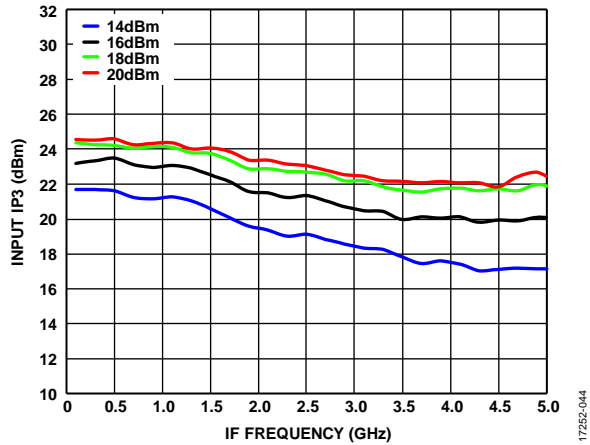

Figure 44. Input IP3 vs. IF Frequency at Various LO Drives, LO Frequency = 32 GHz, T_A = 25°C

AMPLITUDE AND PHASE IMBALANCE PERFORMANCE: DOWNCONVERTER, UPPER SIDEBAND (LOW-SIDE LO)

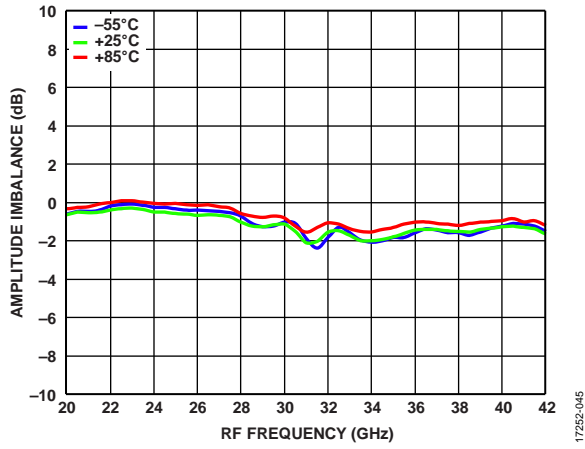

Figure 45. Amplitude Imbalance vs. RF Frequency at Various Temperatures, LO Drive = 18 dBm, IF = 100 MHz

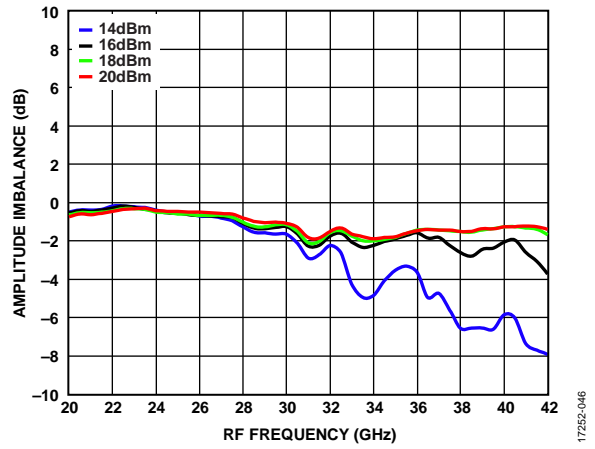

Figure 47. Amplitude Imbalance vs. RF Frequency at Various LO Drives, IF = 100 MHz, T_A = 25°C

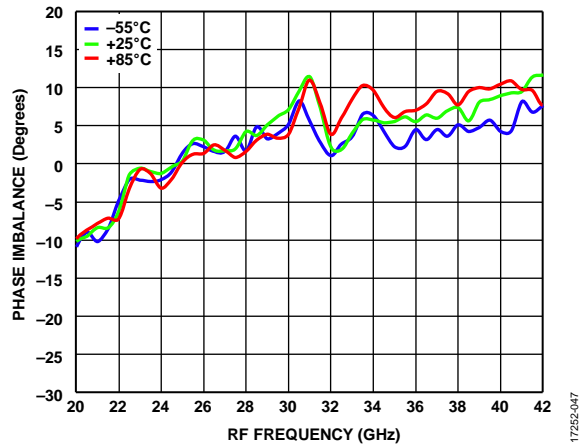

Figure 46. Phase Imbalance vs. RF Frequency at Various Temperatures, LO Drive = 18 dBm, IF = 100 MHz

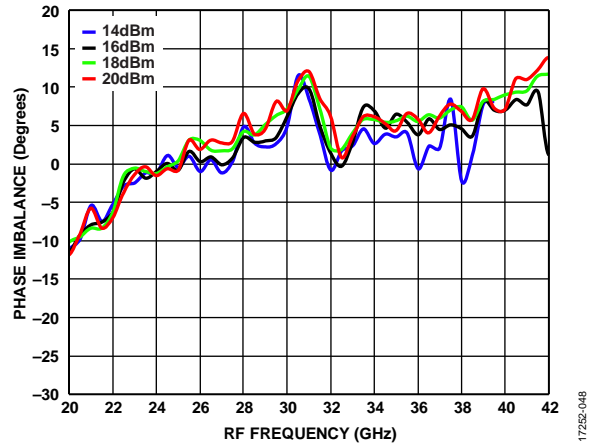

Figure 48. Phase Imbalance vs. RF Frequency at Various LO Drives, IF = 100 MHz, T_A = 25°C

SPURIOUS AND HARMONICS PERFORMANCE

Data was taken without an IF hybrid at the IFx ports. N/A means not applicable.

Downconverter $M \times N$ Spurious Outputs

Mixer spurious products are measured in dBc from the IF output power level, unless otherwise specified. Spur values are $(M \times RF) - (N \times LO)$.

IF = 100 MHz, RF = 20,000 MHz, LO = 19,900 MHz, RF power = -10 dBm, LO power = 18 dBm, and $T_A = 25^\circ\text{C}$.

		N x LO					
		0	1	2	3	4	5
M x RF	0	N/A	6	39	N/A	N/A	N/A
	1	6	0	37	5	N/A	N/A
	2	60	66	64	80	67	N/A
	3	N/A	70	78	66	79	70
	4	N/A	N/A	71	79	95	78
	5	N/A	N/A	N/A	71	82	92

IF = 100 MHz, RF = 30,000 MHz, LO = 29,900 MHz, RF power = -10 dBm, LO power = 18 dBm, and $T_A = 25^\circ\text{C}$.

		N x LO					
		0	1	2	3	4	5
M x RF	0	N/A	12	N/A	N/A	N/A	N/A
	1	9	0	42	N/A	N/A	N/A
	2	N/A	75	71	74	N/A	N/A
	3	N/A	N/A	77	84	75	N/A
	4	N/A	N/A	N/A	77	95	77
	5	N/A	N/A	N/A	N/A	76	95

IF = 100 MHz, RF = 40,000 MHz, LO = 39,900 MHz, RF power = -10 dBm, LO power = 18 dBm, and $T_A = 25^\circ\text{C}$.

		N x LO					
		0	1	2	3	4	5
M x RF	0	N/A	8	N/A	N/A	N/A	N/A
	1	3	0	28	N/A	N/A	N/A
	2	N/A	67	58	67	N/A	N/A
	3	N/A	N/A	68	74	66	N/A
	4	N/A	N/A	N/A	68	90	67
	5	N/A	N/A	N/A	N/A	68	92

IF = 100 MHz, RF = 20,000 MHz, LO = 20,100 MHz, RF power = -10 dBm, LO power = 18 dBm, and $T_A = 25^\circ\text{C}$.

		N x LO					
		0	1	2	3	4	5
M x RF	0	N/A	6	32	N/A	N/A	N/A
	1	6	0	40	59	N/A	N/A
	2	59	66	64	77	68	N/A
	3	N/A	69	79	65	78	68
	4	N/A	N/A	68	78	95	81
	5	N/A	N/A	N/A	70	81	94

IF = 100 MHz, RF = 30,000 MHz, LO = 31,100 MHz, RF power = -10 dBm, LO power = 18 dBm, and $T_A = 25^\circ\text{C}$.

		N x LO					
		0	1	2	3	4	5
M x RF	0	N/A	13	N/A	N/A	N/A	N/A
	1	8	0	39	N/A	N/A	N/A
	2	N/A	76	68	76	N/A	N/A
	3	N/A	N/A	77	87	76	N/A
	4	N/A	N/A	N/A	75	97	75
	5	N/A	N/A	N/A	N/A	78	96

IF = 100 MHz, RF = 40,000 MHz, LO = 40,100 MHz, RF power = -10 dBm, LO power = 18 dBm, and $T_A = 25^\circ\text{C}$.

		N x LO					
		0	1	2	3	4	5
M x RF	0	N/A	8	N/A	N/A	N/A	N/A
	1	1	0	28	N/A	N/A	N/A
	2	N/A	67	57	65	N/A	N/A
	3	N/A	N/A	68	67	66	N/A
	4	N/A	N/A	N/A	67	83	66
	5	N/A	N/A	N/A	N/A	67	90

Upconverter M × N Spurious Outputs

Mixer spurious products are measured in dBc from the RF output power level, unless otherwise specified. Hybrid loss is not de-embedded.

IF = 100 MHz, RF = 20,000 MHz, LO = 19,900 MHz, IF power = -10 dBm, LO power = 18 dBm, and T_A = 25°C.

		N × LO					
		0	1	2	3	4	5
M × IF	-5	95	79	70	N/A	N/A	N/A
	-4	93	79	67	N/A	N/A	N/A
	-3	94	67	69	N/A	N/A	N/A
	-2	75	44	67	N/A	N/A	N/A
	-1	39	0	27	N/A	N/A	N/A
	0	N/A	4	22	N/A	N/A	N/A
	+1	39	0	27	N/A	N/A	N/A
	+2	75	43	61	N/A	N/A	N/A
	+3	96	68	70	N/A	N/A	N/A
	+4	94	80	69	N/A	N/A	N/A
+5	93	78	70	N/A	N/A	N/A	

IF = 100 MHz, RF = 30,000 MHz, LO = 29,900 MHz, IF power = -10 dBm, LO power = 18 dBm, and T_A = 25°C.

		N × LO					
		0	1	2	3	4	5
M × IF	-5	94	77	N/A	N/A	N/A	N/A
	-4	92	77	N/A	N/A	N/A	N/A
	-3	97	64	N/A	N/A	N/A	N/A
	-2	78	44	N/A	N/A	N/A	N/A
	-1	40	0	N/A	N/A	N/A	N/A
	0	N/A	2	N/A	N/A	N/A	N/A
	+1	40	0	N/A	N/A	N/A	N/A
	+2	78	45	N/A	N/A	N/A	N/A
	+3	96	65	N/A	N/A	N/A	N/A
	+4	93	72	N/A	N/A	N/A	N/A
+5	95	74	N/A	N/A	N/A	N/A	

IF = 100 MHz, RF = 40,000 MHz, LO = 39,900 MHz, IF power = -10 dBm, LO power = 18 dBm, and T_A = 25°C.

		N × LO					
		0	1	2	3	4	5
M × IF	-5	+93	+70	N/A	N/A	N/A	N/A
	-4	+94	+69	N/A	N/A	N/A	N/A
	-3	+92	+61	N/A	N/A	N/A	N/A
	-2	+77	+45	N/A	N/A	N/A	N/A
	-1	+38	0	N/A	N/A	N/A	N/A
	0	N/A	-3	N/A	N/A	N/A	N/A
	+1	+38	0	N/A	N/A	N/A	N/A
	+2	+77	+43	N/A	N/A	N/A	N/A
	+3	+94	+59	N/A	N/A	N/A	N/A
	+4	+92	+68	N/A	N/A	N/A	N/A
+5	+93	+67	N/A	N/A	N/A	N/A	

IF = 100 MHz, RF = 20,000 MHz, LO = 20,100 MHz, IF power = -10 dBm, LO power = 18 dBm, and T_A = 25°C.

		N × LO					
		0	1	2	3	4	5
M × IF	-5	93	80	73	N/A	N/A	N/A
	-4	94	80	70	N/A	N/A	N/A
	-3	95	67	68	N/A	N/A	N/A
	-2	71	44	64	N/A	N/A	N/A
	-1	39	0	27	N/A	N/A	N/A
	0	N/A	4	19	N/A	N/A	N/A
	+1	39	0	26	N/A	N/A	N/A
	+2	70	43	59	N/A	N/A	N/A
	+3	95	69	71	N/A	N/A	N/A
	+4	95	80	71	N/A	N/A	N/A
+5	96	81	70	N/A	N/A	N/A	

IF = 100 MHz, RF = 30,000 MHz, LO = 30,100 MHz, IF power = -10 dBm, LO power = 18 dBm, and T_A = 25°C.

		N × LO					
		0	1	2	3	4	5
M × IF	-5	94	74	N/A	N/A	N/A	N/A
	-4	98	74	N/A	N/A	N/A	N/A
	-3	96	64	N/A	N/A	N/A	N/A
	-2	79	44	N/A	N/A	N/A	N/A
	-1	41	0	N/A	N/A	N/A	N/A
	0	N/A	1	N/A	N/A	N/A	N/A
	+1	41	0	N/A	N/A	N/A	N/A
	+2	79	44	N/A	N/A	N/A	N/A
	+3	96	66	N/A	N/A	N/A	N/A
	+4	97	75	N/A	N/A	N/A	N/A
+5	95	74	N/A	N/A	N/A	N/A	

IF = 100 MHz, RF = 40,000 MHz, LO = 40,100 MHz, IF power = -10 dBm, LO power = 18 dBm, and T_A = 25°C.

		N × LO					
		0	1	2	3	4	5
M × IF	-5	+93	+68	N/A	N/A	N/A	N/A
	-4	+94	+70	N/A	N/A	N/A	N/A
	-3	+95	+62	N/A	N/A	N/A	N/A
	-2	+77	+45	N/A	N/A	N/A	N/A
	-1	+39	0	N/A	N/A	N/A	N/A
	0	N/A	-3	N/A	N/A	N/A	N/A
	+1	+39	0	N/A	N/A	N/A	N/A
	+2	+77	+42	N/A	N/A	N/A	N/A
	+3	+95	+62	N/A	N/A	N/A	N/A
	+4	+95	+70	N/A	N/A	N/A	N/A
+5	+94	+69	N/A	N/A	N/A	N/A	

THEORY OF OPERATION

The HMC8192-Die is a passive, wideband, I/Q MMIC mixer that can be used either as an image rejection mixer for receiver operations or as a single-sideband upconverter for transmitter operations. The RF and LO range from 20 GHz to 42 GHz and the IF ranges from dc to 5 GHz.

The HMC8192-Die offers excellent image rejection due to its I/Q architecture design. This mixer is also excellent at LO to RF and LO to IF isolation and reduces the effect of LO leakage due to its double balanced architecture.

The HMC8192-Die is a passive mixer and does not require any dc power sources. As a result, the HMC8192-Die offers a lower noise figure compared to an active mixer, which also ensures

superior dynamic range for high performance and precision applications.

The HMC8192-Die is fabricated on a GaAs MESFET process and uses Analog Devices mixer cells and a 90° hybrid. The HMC8192-Die operates over a -55°C to +85°C temperature range.

For both upconversion and downconversion, an external 90° hybrid is required. See the Applications Information section for details on interfacing with an external 90° hybrid as well as information about switching between upconverter and downconverter modes and how to select sidebands in each mode.

APPLICATIONS INFORMATION

Figure 49 shows the typical application circuit for the HMC8192-Die. To select the appropriate sideband, an external 90° hybrid is needed. For applications not requiring operation to dc, use an off-chip dc blocking capacitor. For applications that require the LO signal at the output to be suppressed, use a bias tee or RF feed as shown in Figure 49. Ensure that the source or sink current used for LO suppression is less than 3 mA for each IFx port to prevent damage to the device. The common-mode voltage for each IFx port is 0 V.

To select the upper sideband when using the HMC8192-Die as an upconverter, connect the IF1 pin to the 90° port of the hybrid and connect the IF2 pin to the 0° port of the hybrid. To

select the lower sideband, connect the IF1 pin to the 0° port of the hybrid and the IF2 pin to the 90° port of the hybrid. The input is from the sum port of the hybrid, and the difference port is 50 Ω terminated.

To select the upper sideband (low-side LO) when using the HMC8192-Die as a downconverter, connect the IF1 pin to the 0° port of the hybrid and connect the IF2 pin to the 90° port of the hybrid. To select the lower sideband (high-side LO), connect the IF1 pin to the 90° port of the hybrid and the IF2 pin to the 0° port of the hybrid. The output is from the sum port of the hybrid, and the difference port is 50 Ω terminated.

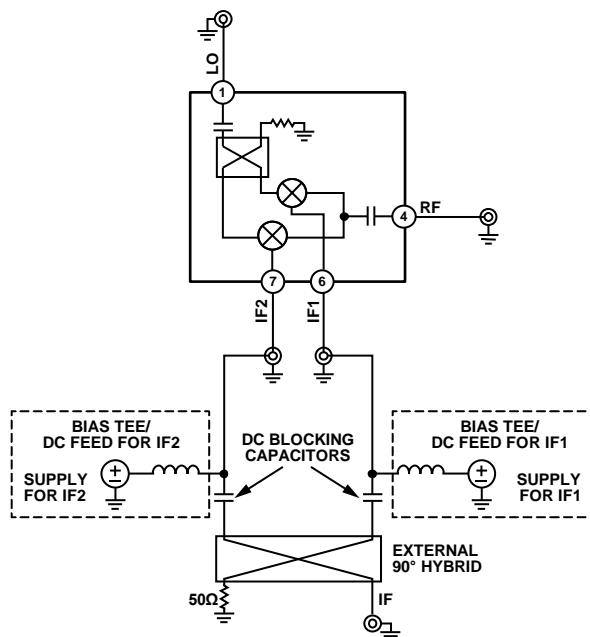

NOTES
1. DASHED SECTIONS ARE OPTIONAL AND MEANT FOR LO NULLING.

Figure 49. Typical Applications Circuit

17252-04B

MOUNTING AND BONDING TECHNIQUES FOR MILLIMETER WAVE GAAS MMICS

Attach the die directly to the ground plane eutectically or with conductive epoxy.

To bring RF to and from the chip use 50 Ω microstrip transmission lines on 0.127 mm (0.005 in.) thick alumina thin film substrates (see Figure 50).

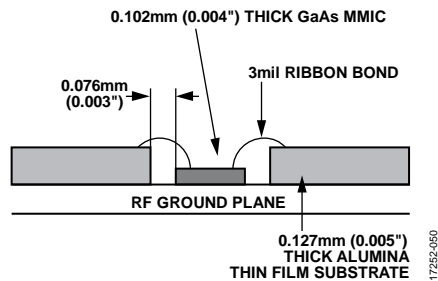

Figure 50. Routing RF Signals

If 0.254 mm (0.010 in.) thick alumina thin film substrates must be used, raise the die 0.152 mm (0.006 in.) so that the surface of the die is coplanar with the surface of the substrate. One way to accomplish this is to attach the 0.102 mm (0.004 in.) thick die to a 0.152 mm (0.006 in.) thick molybdenum heat spreader (molytab), which is then attached to the ground plane (see Figure 51).

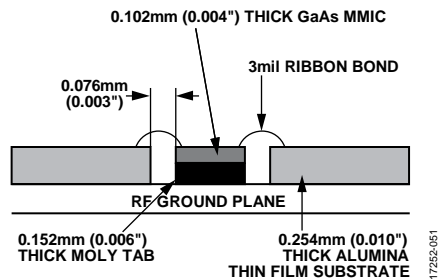

Figure 51. Routing RF Signals (Raised)

Place the microstrip substrates as close to the die as possible to minimize ribbon bond length. Typical die to substrate spacing is 0.075 mm to 0.152 mm (0.003 in. to 0.006 in.). Gold ribbon of 0.075 mm (0.003 in.) width and minimal length < 0.31 mm (< 0.012 in.) is recommended to minimize inductance on the RF, LO, and IF ports.

HANDLING PRECAUTIONS

To avoid permanent damage, adhere to the following precautions.

Storage

All bare die ship in either waffle-based or gel-based ESD protective containers, and then sealed in an ESD protective bag.

After opening the sealed ESD protective bag, all die must be stored in a dry nitrogen environment.

Cleanliness

Handle the chips in a clean environment. Never use liquid cleaning systems to clean the chip.

Static Sensitivity

Follow ESD precautions to protect against ESD strikes.

Transients

Suppress instrument and bias supply transients while bias is applied. To minimize inductive pickup, use shielded signal and bias cables.

General Handling

Handle the chip only on the edges using a vacuum collet or with a sharp pair of bent tweezers. Because the surface of the chip has fragile air bridges, never touch the surface of the chip with a vacuum collet, tweezers or fingers.

MOUNTING

The chip is back metallized and can be die mounted with gold/tin (Au/Sn) eutectic preforms or with electrically conductive epoxy. The mounting surface must be clean and flat.

Eutectic Die Attach

It is best to use an 80% Au/20% Sn preform with a work surface temperature of 255°C and a tool temperature of 265°C. When hot 90% nitrogen/10% hydrogen gas is applied, maintain a tool tip temperature at 290°C. Do not expose the chip to a temperature greater than 320°C for more than 20 sec. No more than 3 sec of scrubbing is required for attachment.

Epoxy Die Attach

Apply a minimum amount of epoxy to the mounting surface so that a thin epoxy fillet is observed around the perimeter of the chip after placing it into position. Cure the epoxy per the schedule provided by the manufacturer.

WIRE BONDING

RF bonds made with 0.003 in. \times 0.0005 in. gold ribbon are recommended for the RF ports. These bonds must be thermosonically bonded with a force of 40 g to 60 g. DC bonds of 0.025 mm (0.001 in.) diameter, thermosonically bonded, are recommended. Create ball bonds with a force of 40 g to 50 g and wedge bonds with a force of 18 g to 22 g. Create all bonds with a nominal stage temperature of 150°C. Apply a minimum amount of ultrasonic energy to achieve reliable bonds. Keep all bonds as short as possible, less than 0.31 mm (0.012 in.).

OUTLINE DIMENSIONS

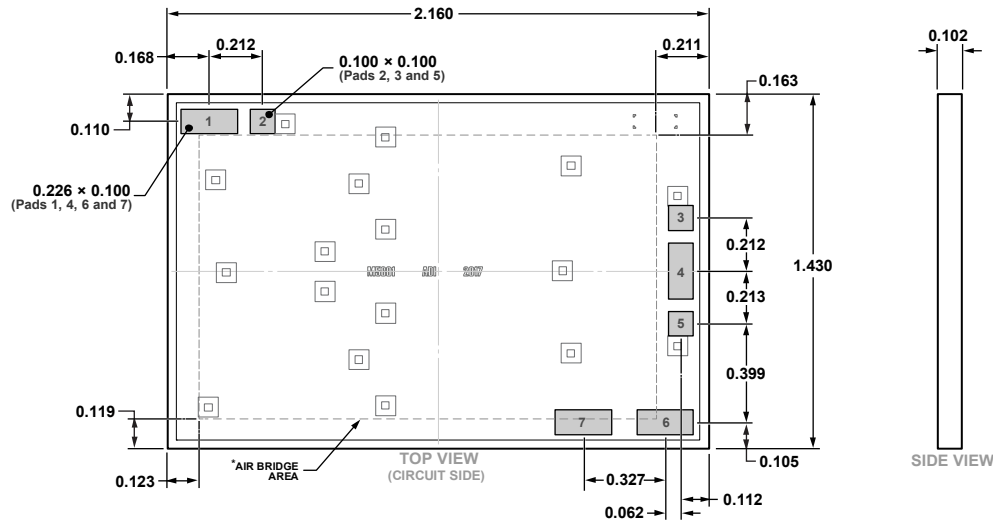

*This die utilizes fragile air bridges. Any pickup tools used must not contact this area.

Figure 52. 7-Pad Bare Die [CHIP]
(C-7-6)
Dimensions shown in millimeters

09-27-2018-A

ORDERING GUIDE

Model ¹	Temperature Range	Package Description	Package Option
HMC8192	-55°C to +85°C	7-Pad Bare Die [CHIP]	C-7-6
HMC8192-SX	-55°C to +85°C	7-Pad Bare Die [CHIP]	C-7-6

¹ The HMC8192 and the HMC8192-SX are RoHS compliant parts.