

### FEATURES

#### Ultralow power operation

##### 3.3 V operation

- 5.6  $\mu\text{A}$  per channel quiescent current, refresh enabled
- 0.3  $\mu\text{A}$  per channel quiescent current, refresh disabled
- 148  $\mu\text{A}/\text{Mbps}$  per channel typical dynamic current

##### 2.5 V operation

- 3.1  $\mu\text{A}$  per channel quiescent current, refresh enabled
- 0.1  $\mu\text{A}$  per channel quiescent current, refresh disabled
- 116  $\mu\text{A}/\text{Mbps}$  per channel typical dynamic current

#### Small, 20-lead SSOP package and small 8-lead SOIC package

#### Bidirectional communication

#### Up to 2 Mbps data rate nonreturn to zero (NRZ)

#### High temperature operation: 125°C

#### High common-mode transient immunity: >25 kV/ $\mu\text{s}$

#### Safety and Regulatory Approvals

##### UL 1577 component recognition program

- 3750 V rms for 1 minute per UL 1577 (20-lead SSOP)
- 3000 V rms for 1 minute per UL 1577 (8-lead SOIC)

##### CSA Component Acceptance Notice 5A

##### VDE certificate of conformity

DIN V VDE V 0884-10 (VDE V 0884-10): 2006-12

$V_{\text{IORM}} = 849 \text{ V peak}$  (20-lead SSOP)

$V_{\text{IORM}} = 560 \text{ V peak}$  (8-lead SOIC)

### APPLICATIONS

#### General-purpose, low power, multichannel isolation

#### 1 MHz low power serial peripheral interface (SPI)

#### 4 mA to 20 mA loop process control

### GENERAL DESCRIPTION

The ADuM1240/ADuM1241/ADuM1245/ADuM1246<sup>1</sup> are micropower, 2-channel, digital isolators based on the Analog Devices, Inc., *iCoupler*® technology. Combining high speed, complementary metal oxide semiconductor (CMOS) and monolithic air core transformer technologies, these isolation components provide outstanding performance characteristics superior to the alternatives, such as optocoupler devices. The 20-lead SSOP version of the ADuM1240/ADuM1241/ADuM1245/ADuM1246 allows control of the internal refresh functions. As shown in Figure 3, in standard operating mode, when  $\text{EN}_x = 0$  (internal refresh enabled), the current per channel is less than 10  $\mu\text{A}$ .

When  $\text{EN}_x = 1$  (internal refresh disabled), the current per channel drops to less than 1  $\mu\text{A}$ .

<sup>1</sup> Protected by U.S. Patents 5,952,849, 6,873,065, 7,075,329, 6,262,600. Other patents pending.

#### Rev. B

#### Document Feedback

Information furnished by Analog Devices is believed to be accurate and reliable. However, no responsibility is assumed by Analog Devices for its use, nor for any infringements of patents or other rights of third parties that may result from its use. Specifications subject to change without notice. No license is granted by implication or otherwise under any patent or patent rights of Analog Devices. Trademarks and registered trademarks are the property of their respective owners.

### FUNCTIONAL BLOCK DIAGRAMS



Figure 1. 20-Lead SSOP Package Functional Block Diagram



Figure 2. 8-Lead SOIC Package Functional Block Diagram

The ADuM1240/ADuM1241/ADuM1245/ADuM1246 are packaged in either a 20-lead SSOP for 3.75 kV reinforced isolation or an 8-lead SOIC for 3 kV basic isolation. The devices meet regulatory requirements, such as UL and CSA standards.

In addition to the space saving package options, the ADuM1240/ADuM1241/ADuM1245/ADuM1246 operate with supplies as low as 2.25 V. All models provide low, pulse width distortion at <8 ns. In addition, every model has an input glitch filter to protect against extraneous noise disturbances.

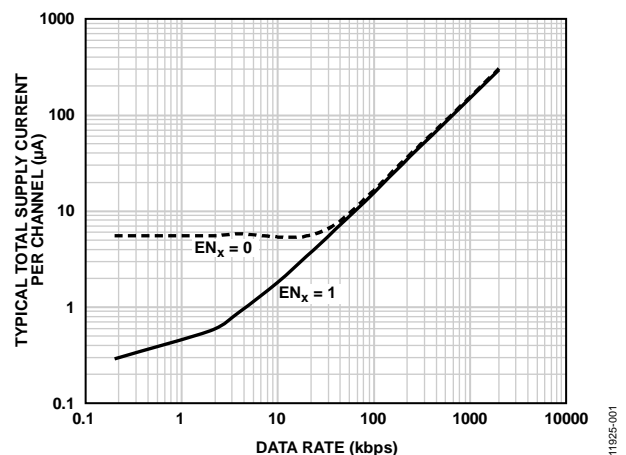

Figure 3. Typical Total Supply Current ( $\text{IDD1} + \text{IDD2}$ ) per Channel ( $\text{VDD}_x = 3.3 \text{ V}$ ) as a Function of Data Rate

## TABLE OF CONTENTS

Features .....	1	Absolute Maximum Ratings .....	10
Applications.....	1	Continuous Working Voltage.....	10
General Description .....	1	ESD Caution.....	10
Functional Block Diagrams.....	1	Pin Configurations and Function Descriptions.....	11
Revision History .....	2	Truth Tables.....	13
Specifications.....	3	Typical Performance Characteristics .....	14
Electrical Characteristics—3.3 V Operation .....	3	Applications Information .....	17
Electrical Characteristics—2.5 V Operation .....	4	PCB Layout .....	17
Electrical Characteristics— $V_{DD1} = 3.3\text{ V}$ , $V_{DD2} = 2.5\text{ V}$ Operation.....	6	Propagation Delay Related Parameters .....	17
Electrical Characteristics— $V_{DD1} = 2.5\text{ V}$ , $V_{DD2} = 3.3\text{ V}$ Operation.....	6	DC Correctness and Low Power Operation.....	17
Package Characteristics .....	7	Magnetic Field Immunity.....	18
Regulatory Information.....	7	Power Consumption .....	19
Insulation and Safety Related Specifications .....	8	Insulation Lifetime .....	19
DIN V VDE V 0884-10 (VDE V 0884-10): 2006-12		Packaging and Ordering Information .....	<b>Error! Bookmark not defined.</b>
Insulation Characteristics.....	8	Outline Dimensions.....	20
Recommended Operating Conditions .....	9	Ordering Guide .....	20

## REVISION HISTORY

### 9/2016—Rev. A to Rev. B

Changes to Features Section.....	1
Changes to Regulatory Information Section and Table 12 .....	7

### 3/2014—Rev. 0 to Rev. A

Added 8-lead SOIC Package .....	Universal
Changes to Features Section, General Description Section, and Figure 3 .....	1
Deleted Product Highlights Section.....	1
Added Figure 2; Renumbered Sequentially .....	1
Changes to Table 12.....	7
Changes to Table 13.....	8
Added Table 14; Renumbered Sequentially .....	8
Changed Case Temperature to Ambient Temperature, Figure 4 Caption .....	9

Added Figure 5.....	11
Changes to Table 19 .....	11
Added Figure 7.....	12
Changes to Table 20 .....	12
Changes to Table 22 and Table 23.....	13
Changes to PCB Layout Section.....	17
Added Figure 28.....	17
Changes to Recommended Input Voltage for Low Power Operation Section.....	18
Added Figure 35, Outline Dimensions.....	20
Changes to Ordering Guide .....	21

### 12/2013—Revision 0: Initial Version

## SPECIFICATIONS

## ELECTRICAL CHARACTERISTICS—3.3 V OPERATION

All typical specifications are at  $T_A = 25^\circ\text{C}$ ,  $V_{DD1} = V_{DD2} = 3.3\text{ V}$ . Minimum and maximum specifications apply over the entire recommended operation range of  $3.0\text{ V} \leq V_{DD1} \leq 3.6\text{ V}$ ,  $3.0\text{ V} \leq V_{DD2} \leq 3.6\text{ V}$ , and  $-40^\circ\text{C} \leq T_A \leq +125^\circ\text{C}$ , unless otherwise noted. Switching specifications are tested with  $C_L = 15\text{ pF}$  and CMOS signal levels, unless otherwise noted.

Table 1.

Parameter	Symbol	Min	Typ	Max	Unit	Test Conditions/Comments
SWITCHING SPECIFICATIONS						
Data Rate				2	Mbps	Within pulse width distortion (PWD) limit
Propagation Delay	$t_{PHL}$ , $t_{PLH}$		80	180	ns	50% input to 50% output
Change vs. Temperature			200		ps/°C	
Minimum Pulse Width	PW	500			ns	Within PWD limit
Pulse Width Distortion	PWD			8	ns	$ t_{PLH} - t_{PHL} $
Propagation Delay Skew <sup>1</sup>	$t_{PSK}$			10	ns	
Channel Matching						
Codirectional	$t_{PSKCD}$			10	ns	
Opposing Direction	$t_{PSKOD}$			15	ns	

<sup>1</sup>  $t_{PSK}$  is the magnitude of the worst case difference in  $t_{PHL}$  and  $t_{PLH}$  that is measured between units at the same operating temperature, supply voltages, and output load within the recommended operating conditions.

Table 2.

Parameter	Symbol	Min	Typ	Max	Unit	Test Conditions/Comments
SUPPLY CURRENT						
ADuM1240/ADuM1245	$I_{DD1}$		366	600	$\mu\text{A}$	2 Mbps, no load
	$I_{DD2}$		246	375	$\mu\text{A}$	
ADuM1241/ADuM1246	$I_{DD1}$		306	450	$\mu\text{A}$	
	$I_{DD2}$		306	450	$\mu\text{A}$	

Table 3.

Parameter	Symbol	Min	Typ	Max	Unit	Test Conditions/Comments
DC SPECIFICATIONS						
Input Threshold						
Logic High	$V_{IH}$	$0.7 V_{DDx}^1$			V	
Logic Low	$V_{IL}$			$0.3 V_{DDx}^1$	V	
Output Voltages						
Logic High	$V_{OH}$	$V_{DDx}^1 - 0.1$	3.3		V	$I_{OUTx} = -20\text{ }\mu\text{A}$ , $V_{ix} = V_{ixH}$
		$V_{DDx}^1 - 0.4$	3.1		V	$I_{OUTx} = -4\text{ mA}$ , $V_{ix} = V_{ixH}$
Logic Low	$V_{OL}$		0.0	0.1	V	$I_{OUTx} = 20\text{ }\mu\text{A}$ , $V_{ix} = V_{ixL}$
			0.2	0.4	V	$I_{OUTx} = 4\text{ mA}$ , $V_{ix} = V_{ixL}$
Input Current per Channel	$I_i$	-1	+0.01	+1	$\mu\text{A}$	$0\text{ V} \leq V_{ix} \leq V_{DDx}^1$
Input Switching Thresholds						
Positive Threshold Voltage	$V_{T+}$		1.8		V	
Negative Going Threshold	$V_{T-}$		1.2		V	
Input Hysteresis	$\Delta V_T$		0.6		V	
Undervoltage Lockout, $V_{DD1}$ or $V_{DD2}$	UVLO		1.5		V	
Supply Current per Channel						
Quiescent Current						
Input Supply	$I_{DD1(Q)}$		4.8	10	$\mu\text{A}$	EN <sub>x</sub> low
Output Supply	$I_{DDO(Q)}$		0.8	6	$\mu\text{A}$	EN <sub>x</sub> low
Input (Refresh Off)	$I_{DD1(Q)}$		0.12		$\mu\text{A}$	EN <sub>x</sub> high
Output (Refresh Off)	$I_{DDO(Q)}$		0.13		$\mu\text{A}$	EN <sub>x</sub> high

Parameter	Symbol	Min	Typ	Max	Unit	Test Conditions/Comments
Dynamic Supply Current						
Input	$I_{DD1(D)}$		88		$\mu\text{A}/\text{Mbps}$	
Output	$I_{DDO(D)}$		60		$\mu\text{A}/\text{Mbps}$	
AC SPECIFICATIONS						
Output Rise Time/Fall Time	$t_{R}/t_{F}$		2		ns	10% to 90%
Common-Mode Transient Immunity <sup>2</sup>	$ CM $	25	40		kV/ $\mu\text{s}$	$V_{IX} = V_{DDX}^1$ , $V_{CM} = 1000\text{ V}$ , transient magnitude = 800 V
Refresh Rate	$f_r$		14		kbps	

<sup>1</sup>  $V_{DDX} = V_{DD1}$  or  $V_{DD2}$ .

<sup>2</sup>  $|CM|$  is the maximum common-mode voltage slew rate that can be sustained while maintaining  $V_{OUT} > 0.8 V_{DDX}$ . The common-mode voltage slew rates apply to both rising and falling common-mode voltage edges.

## ELECTRICAL CHARACTERISTICS—2.5 V OPERATION

All typical specifications are at  $T_A = 25^\circ\text{C}$ ,  $V_{DD1} = V_{DD2} = 2.5\text{ V}$ . Minimum and maximum specifications apply over the entire recommended operation range of  $2.25\text{ V} \leq V_{DD1} \leq 2.75\text{ V}$ ,  $2.25\text{ V} \leq V_{DD2} \leq 2.75\text{ V}$ , and  $-40^\circ\text{C} \leq T_A \leq +125^\circ\text{C}$ , unless otherwise noted. Switching specifications are tested with  $C_L = 15\text{ pF}$  and CMOS signal levels, unless otherwise noted.

Table 4.

Parameter	Symbol	Min	Typ	Max	Unit	Test Conditions/Comments
SWITCHING SPECIFICATIONS						
Data Rate				2	Mbps	Within PWD limit
Propagation Delay	$t_{PHL}, t_{PLH}$		112	180	ns	50% input to 50% output
Change vs. Temperature			280		ps/ $^\circ\text{C}$	
Pulse Width Distortion	PWD			12	ns	$ t_{PLH} - t_{PHL} $
Minimum Pulse Width	PW	500			ns	Within PWD limit
Propagation Delay Skew <sup>1</sup>	$t_{PSK}$			10	ns	
Channel Matching						
Codirectional	$t_{PSKCD}$			10	ns	
Opposing Direction	$t_{PSKOD}$			30	ns	

<sup>1</sup>  $t_{PSK}$  is the magnitude of the worst case difference in  $t_{PHL}$  or  $t_{PLH}$  that is measured between units at the same operating temperature, supply voltages, and output load within the recommended operating conditions.

Table 5.

Parameter	Symbol	Min	Typ	Max	Unit	Test Conditions/Comments
SUPPLY CURRENT						
ADuM1240/ADuM1245	$I_{DD1}$		312	400	$\mu\text{A}$	2 Mbps, no load
	$I_{DD2}$		168	250	$\mu\text{A}$	
ADuM1241/ADuM1246	$I_{DD1}$		240	375	$\mu\text{A}$	
	$I_{DD2}$		240	375	$\mu\text{A}$	

Table 6.

Parameter	Symbol	Min	Typ	Max	Unit	Test Conditions/Comments
DC SPECIFICATIONS						
Input Threshold						
Logic High	$V_{IH}$	$0.7 V_{DDx}^1$			V	
Logic Low	$V_{IL}$			$0.3 V_{DDx}^1$	V	
Output Voltages						
Logic High	$V_{OH}$	$V_{DDx}^1 - 0.1$	2.5		V	$I_{Ox} = -20 \mu A, V_{Ix} = V_{IxH}$
		$V_{DDx}^1 - 0.4$	2.35		V	$I_{Ox} = -4 \text{ mA}, V_{Ix} = V_{IxH}$
Logic Low	$V_{OL}$		0.0	0.1	V	$I_{Ox} = 20 \mu A, V_{Ix} = V_{IxL}$
			0.1	0.4	V	$I_{Ox} = 4 \text{ mA}, V_{Ix} = V_{IxL}$
Input Current per Channel	$I_I$	-1	+0.01	+1	$\mu A$	$0 V \leq V_{Ix} \leq V_{DDx}^1$
Input Switching Thresholds						
Positive Threshold Voltage	$V_{T+}$		1.5		V	
Negative Going Threshold	$V_{T-}$		1.0		V	
Input Hysteresis	$\Delta V_T$		0.5		V	
Undervoltage Lockout, $V_{DD1}$ or $V_{DD2}$	UVLO		1.5		V	
Supply Current per Channel						
Quiescent Current						
Input Supply	$I_{DDI(Q)}$		2.6	3.75	$\mu A$	EN <sub>x</sub> low
Output Supply	$I_{DDO(Q)}$		0.5	3.75	$\mu A$	EN <sub>x</sub> low
Input (Refresh Off)	$I_{DDI(Q)}$		0.05		$\mu A$	EN <sub>x</sub> high
Output (Refresh Off)	$I_{DDO(Q)}$		0.05		$\mu A$	EN <sub>x</sub> high
Dynamic Supply Current						
Input	$I_{DDI(D)}$		76		$\mu A/Mbps$	
Output	$I_{DDO(D)}$		41		$\mu A/Mbps$	
AC SPECIFICATIONS						
Output Rise Time/Fall Time	$t_R/t_F$		2		ns	10% to 90%
Common-Mode Transient Immunity <sup>2</sup>	$ CM $	25	40		kV/ $\mu s$	$V_{Ix} = V_{DDx}^1, V_{CM} = 1000 \text{ V},$ transient magnitude = 800 V
Refresh Rate	$f_r$		14		kbps	

<sup>1</sup>  $V_{DDx} = V_{DD1}$  or  $V_{DD2}$ .<sup>2</sup>  $|CM|$  is the maximum common-mode voltage slew rate that can be sustained while maintaining  $V_{OUT} > 0.8 V_{DDx}$ . The common-mode voltage slew rates apply to both rising and falling common-mode voltage edges.

**ELECTRICAL CHARACTERISTICS— $V_{DD1} = 3.3\text{ V}$ ,  $V_{DD2} = 2.5\text{ V}$  OPERATION**

All typical specifications are at  $T_A = 25^\circ\text{C}$ ,  $V_{DD1} = 3.3\text{ V}$ , and  $V_{DD2} = 2.5\text{ V}$ . Minimum and maximum specifications apply over the entire recommended operation range of  $3.0\text{ V} \leq V_{DD1} \leq 3.6\text{ V}$ ,  $2.25\text{ V} \leq V_{DD2} \leq 2.75\text{ V}$ , and  $-40^\circ\text{C} \leq T_A \leq +125^\circ\text{C}$ , unless otherwise noted. Switching specifications are tested with  $C_L = 15\text{ pF}$  and CMOS signal levels, unless otherwise noted.

For dc specifications and ac specifications, see Table 3 for parameters related to Side 1 operation, and see Table 6 for parameters related to Side 2 operation.

**Table 7.**

Parameter	Symbol	Min	Typ	Max	Unit	Test Conditions/Comments
SWITCHING SPECIFICATIONS						
Data Rate				2	Mbps	Within PWD limit
Propagation Delay						
Side 1 to Side 2	$t_{PHL}$ , $t_{PLH}$		84	180	ns	50% input to 50% output
Side 2 to Side 1	$t_{PHL}$ , $t_{PLH}$		120	180	ns	50% input to 50% output
Change vs. Temperature			280		ps/ $^\circ\text{C}$	
Pulse Width Distortion	PWD			12	ns	$ t_{PLH} - t_{PHL} $
Pulse Width	PW	500			ns	Within PWD limit
Propagation Delay Skew <sup>1</sup>	$t_{PSK}$			10	ns	
Channel Matching						
Codirectional	$t_{PSKCD}$			10	ns	
Opposing Direction	$t_{PSKOD}$			60	ns	

<sup>1</sup>  $t_{PSK}$  is the magnitude of the worst case difference in  $t_{PHL}$  or  $t_{PLH}$  that is measured between units at the same operating temperature, supply voltages, and output load within the recommended operating conditions.

**Table 8.**

Parameter	Symbol	Min	Typ	Max	Unit	Test Conditions/Comments
SUPPLY CURRENT						
ADuM1240/ADuM1245	$I_{DD1}$		366	500	$\mu\text{A}$	2 Mbps, no load
	$I_{DD2}$		168	375	$\mu\text{A}$	
ADuM1241/ADuM1246	$I_{DD1}$		306	400	$\mu\text{A}$	
	$I_{DD2}$		240	375	$\mu\text{A}$	

**ELECTRICAL CHARACTERISTICS— $V_{DD1} = 2.5\text{ V}$ ,  $V_{DD2} = 3.3\text{ V}$  OPERATION**

All typical specifications are at  $T_A = 25^\circ\text{C}$ ,  $V_{DD1} = 2.5\text{ V}$ , and  $V_{DD2} = 3.3\text{ V}$ . Minimum and maximum specifications apply over the entire recommended operation range of  $2.25\text{ V} \leq V_{DD1} \leq 2.75\text{ V}$ ,  $3.0\text{ V} \leq V_{DD2} \leq 3.6\text{ V}$ , and  $-40^\circ\text{C} \leq T_A \leq +125^\circ\text{C}$ , unless otherwise noted. Switching specifications are tested with  $C_L = 15\text{ pF}$  and CMOS signal levels, unless otherwise noted.

For dc specifications and ac specifications, see Table 6 for parameters related to Side 1 operation, and see Table 3 for parameters related to Side 2 operation.

**Table 9.**

Parameter	Symbol	Min	Typ	Max	Unit	Test Conditions/Comments
SWITCHING SPECIFICATIONS						
Data Rate				2	Mbps	Within PWD limit
Propagation Delay						
Side 1 to Side 2	$t_{PHL}$ , $t_{PLH}$		120	180	ns	50% input to 50% output
Side 2 to Side 1	$t_{PHL}$ , $t_{PLH}$		84	180	ns	50% input to 50% output
Change vs. Temperature			200		ps/ $^\circ\text{C}$	
Pulse Width Distortion	PWD			12	ns	$ t_{PLH} - t_{PHL} $
Pulse Width	PW	500			ns	Within PWD limit
Propagation Delay Skew <sup>1</sup>	$t_{PSK}$			10	ns	
Channel Matching						
Codirectional	$t_{PSKCD}$			10	ns	
Opposing Direction	$t_{PSKOD}$			60	ns	

<sup>1</sup>  $t_{PSK}$  is the magnitude of the worst case difference in  $t_{PHL}$  or  $t_{PLH}$  that is measured between units at the same operating temperature, supply voltages, and output load within the recommended operating conditions.

Table 10.

Parameter	Symbol	Min	Typ	Max	Unit	Test Conditions/Comments
SUPPLY CURRENT						2 Mbps, no load
ADuM1240/ADuM1245	I <sub>DD1</sub>		306	500	μA	
	I <sub>DD2</sub>		248	375	μA	
ADuM1241/ADuM1246	I <sub>DD1</sub>		240	375	μA	
	I <sub>DD2</sub>		306	450	μA	

## PACKAGE CHARACTERISTICS

Table 11.

Parameter	Symbol	Min	Typ	Max	Unit	Test Conditions/Comments
Resistance (Input to Output) <sup>1</sup>	R <sub>I-O</sub>		10 <sup>13</sup>		Ω	
Capacitance (Input to Output) <sup>1</sup>	C <sub>I-O</sub>		2		pF	f = 1 MHz
Input Capacitance <sup>2</sup>	C <sub>I</sub>		4.0		pF	
IC Junction to Ambient Thermal Resistance	θ <sub>JA</sub>		85		°C/W	Thermocouple located at center of package underside

<sup>1</sup> The device is considered a 2-terminal device: Pin 1 through Pin 8 are shorted together, and Pin 9 through Pin 16 are shorted together.

<sup>2</sup> Input capacitance is from any input data pin to ground.

## REGULATORY INFORMATION

See Table 18 and the Absolute Maximum Ratings section for recommended maximum working voltages for specific cross isolation waveforms and insulation levels.

Table 12.

UL	CSA	VDE
Recognized under 1577 component recognition program <sup>1</sup>	Approved under CSA Component Acceptance Notice 5A	Certified according to DIN V VDE V 0884-10 (VDE V 0884-10): 2006-12 <sup>2</sup>
Single protection, 8-lead SOIC package, 3000 V rms isolation voltage	8-lead SOIC package, basic insulation per CSA 60950-1-03 and IEC 60950-1, 400 V rms (565 V peak) maximum working voltage	8-lead SOIC package, reinforced insulation, 560 V <sub>PEAK</sub>
Single protection, 20-lead SSOP package, 3750 V rms isolation voltage	20-lead SSOP package, basic insulation per CSA 60950-1-03 and IEC 60950-1, 530 V rms (700 V peak) maximum working voltage 20-lead SSOP package, reinforced insulation per CSA 60950-1-03 and IEC 60950-1, 265 V rms (374 V peak) maximum working voltage	20-lead SSOP package, reinforced insulation, 849 V <sub>PEAK</sub>
File E214100	File 205078	File 2471900-4880-0001

<sup>1</sup> In accordance with UL1577, each ADuM1240/ADuM1241/ADuM1245/ADuM1246 is proof tested by applying an insulation test voltage ≥3000 V rms for 1 second (current leakage detection limit = 5 μA).

<sup>2</sup> In accordance with DIN V VDE V 0884-10, each ADuM1240/ADuM1241/ADuM1245/ADuM1246 is proof tested by applying an insulation test voltage ≥1050 V peak for 1 second (partial discharge detection limit = 5 pC). The asterisk (\*) marked on the component designates DIN V VDE V 0884-10 approval.

## INSULATION AND SAFETY RELATED SPECIFICATIONS

Table 13.

Parameter	Symbol	Value	Unit	Test Conditions/Comments
Rated Dielectric Insulation Voltage (8-Lead SOIC)		3000	V rms	1 minute duration
Rated Dielectric Insulation Voltage (20-Lead SSOP)		3750	V rms	1 minute duration
Minimum External Tracking and Air Gap, 8-Lead SOIC (Creepage and Clearance)	L(I02)	4	mm min	Measured from input terminals to output terminals, shortest distance path along package body
Minimum Clearance in the Plane of the Printed Circuit Board, 8-Lead SOIC (PCB Clearance)	L(I01)	4.5	mm min	Measured from input terminals to output terminals, shortest distance through air, line of sight, in the PCB mounting plane
Minimum Clearance in the Plane of the Printed Circuit Board, 20-Lead SSOP (PCB Clearance)	L(I01)	5.1	mm min	Measured from input terminals to output terminals, shortest distance path along package body
Minimum Clearance in the Plane of the Printed Circuit Board, 20-Lead SSOP (PCB Clearance)	L(I02)	5.1	mm min	Measured from input terminals to output terminals, shortest distance through air, line of sight, in the PCB mounting plane
Minimum Internal Gap (Internal Clearance)		0.017	mm min	Insulation distance through insulation
Tracking Resistance (Comparative Tracking Index)	CTI	>400	V	DIN IEC 112/VDE 0303 Part 1
Isolation Group		II		Material Group (DIN VDE 0110, 1/89, Table 1)

## DIN V VDE V 0884-10 (VDE V 0884-10): 2006-12 INSULATION CHARACTERISTICS

These isolators are suitable for reinforced electrical isolation within the safety limit data only. Maintenance of the safety data is ensured by protective circuits. The asterisk (\*) marked on packages denotes DIN V VDE V 0884-10 approval.

Table 14. 8-Lead SOIC (R-8)

Parameter	Symbol	Test Conditions/Comments	Characteristic	Unit
Installation Classification per DIN VDE 0110 For Rated Mains Voltage $\leq 150$ V rms For Rated Mains Voltage $\leq 300$ V rms For Rated Mains Voltage $\leq 400$ V rms			I to IV I to III I to II	
Climatic Classification			40/105/21	
Pollution Degree per DIN VDE 0110, Table 1			2	
Maximum Working Insulation Voltage	$V_{IORM}$		560	$V_{PEAK}$
Input to Output Test Voltage, Method b1	$V_{pd(m)}$	$V_{IORM} \times 1.875 = V_{pd(m)}$ , 100% production test, $t_{ini} = t_m =$ one second, partial discharge $< 5$ pC	1050	$V_{PEAK}$
Input to Output Test Voltage, Method a After Environmental Tests Subgroup 1	$V_{pd(m)}$	$V_{IORM} \times 1.5 = V_{pd(m)}$ , $t_{ini} = 60$ seconds, $t_m = 10$ seconds, partial discharge $< 5$ pC	840	$V_{PEAK}$
After Input and/or Safety Test Subgroup 2 and Subgroup 3	$V_{pd(m)}$	$V_{IORM} \times 1.2 = V_{pd(m)}$ , $t_{ini} = 60$ seconds, $t_m = 10$ seconds, partial discharge $< 5$ pC	672	$V_{PEAK}$
Highest Allowable Overtolerance	$V_{IOTM}$		3500	$V_{PEAK}$
Surge Isolation Voltage	$V_{IOSM}$	$V_{PEAK} = 10$ kV, 1.2 $\mu$ s rise time, 50 $\mu$ s, 50% fall time	4000	$V_{PEAK}$
Safety Limiting Values		Maximum value allowed in the event of a failure (see Figure 4)		
Case Temperature	$T_S$		150	$^{\circ}$ C
Total Power Dissipation at 25 $^{\circ}$ C	$I_{S1}$		1.64	W
Insulation Resistance at $T_S$	$R_S$	$V_{IO} = 500$ V	$> 10^9$	$\Omega$



Table 15. 20-Lead SSOP (RS-20)

Parameter	Symbol	Test Conditions/Comments	Characteristic	Unit
Installation Classification per DIN VDE 0110 For Rated Mains Voltage ≤ 150 V rms For Rated Mains Voltage ≤ 300 V rms For Rated Mains Voltage ≤ 400 V rms			I to IV I to III I to II	
Climatic Classification			40/105/21	
Pollution Degree per DIN VDE 0110, Table 1			2	
Maximum Working Insulation Voltage	V <sub>IORM</sub>		849	V <sub>PEAK</sub>
Input to Output Test Voltage, Method b1	V <sub>pd(m)</sub>	V <sub>IORM</sub> × 1.875 = V <sub>pd(m)</sub> , 100% production test, t <sub>ini</sub> = t <sub>m</sub> = one second, partial discharge < 5 pC	1592	V <sub>PEAK</sub>
Input to Output Test Voltage, Method a After Environmental Tests Subgroup 1	V <sub>pd(m)</sub>	V <sub>IORM</sub> × 1.5 = V <sub>pd(m)</sub> , t <sub>ini</sub> = 60 seconds, t <sub>m</sub> = 10 seconds, partial discharge < 5 pC	1273	V <sub>PEAK</sub>
After Input and/or Safety Test Subgroup 2 and Subgroup 3	V <sub>pd(m)</sub>	V <sub>IORM</sub> × 1.2 = V <sub>pd(m)</sub> , t <sub>ini</sub> = 60 seconds, t <sub>m</sub> = 10 seconds, partial discharge < 5 pC	1018	V <sub>PEAK</sub>
Highest Allowable Overvoltage	V <sub>IOTM</sub>		5335	V <sub>PEAK</sub>
Surge Isolation Voltage	V <sub>IOSM</sub>	V <sub>PEAK</sub> = 10 kV, 1.2 μs rise time, 50 μs, 50% fall time	6000	V <sub>PEAK</sub>
Safety Limiting Values		Maximum value allowed in the event of a failure (see Figure 4)		
Case Temperature	T <sub>S</sub>		150	°C
Side 1 I <sub>DD1</sub> Current	I <sub>S1</sub>		2.5	W
Insulation Resistance at T <sub>S</sub>	R <sub>S</sub>	V <sub>IO</sub> = 500 V	>10 <sup>9</sup>	Ω



Figure 4. Thermal Derating Curve, Dependent on Safety Limiting Values with Ambient Temperature per DIN V VDE V 0884-10

RECOMMENDED OPERATING CONDITIONS

Table 16.

Parameter	Symbol	Min	Max	Unit
Operating Temperature	T <sub>A</sub>	-40	+125	°C
Supply Voltages <sup>1</sup>	V <sub>DD1</sub> , V <sub>DD2</sub>	2.25	3.6	V
Input Signal Rise and Fall Times			1.0	ms

<sup>1</sup> See the DC Correctness and Low Power Operation section for more information.

**ABSOLUTE MAXIMUM RATINGS**

$T_A = 25^\circ\text{C}$ , unless otherwise noted.

Table 17.

Parameter	Rating
Storage Temperature ( $T_{ST}$ ) Range	$-65^\circ\text{C}$ to $+150^\circ\text{C}$
Ambient Operating Temperature ( $T_A$ ) Range	$-40^\circ\text{C}$ to $+125^\circ\text{C}$
Supply Voltages ( $V_{DD1}$ , $V_{DD2}$ )	$-0.5\text{ V}$ to $+5\text{ V}$
Input Voltages ( $V_{IA}$ , $V_{IB}$ )	$-0.5\text{ V}$ to $V_{DD1} + 0.5\text{ V}$
Output Voltages ( $V_{OA}$ , $V_{OB}$ )	$-0.5\text{ V}$ to $V_{DD2} + 0.5\text{ V}$
Average Output Current per Pin <sup>1</sup>	
Side 1 ( $I_{O1}$ )	$-10\text{ mA}$ to $+10\text{ mA}$
Side 2 ( $I_{O2}$ )	$-10\text{ mA}$ to $+10\text{ mA}$
Common-Mode Transients <sup>2</sup>	$-100\text{ kV}/\mu\text{s}$ to $+100\text{ kV}/\mu\text{s}$

<sup>1</sup> See Figure 4 for maximum rated current values for various temperatures.

<sup>2</sup> Refers to common-mode transients across the insulation barrier. Common-mode transients exceeding the absolute maximum ratings can cause latch-up or permanent damage.

Stresses at or above those listed under Absolute Maximum Ratings may cause permanent damage to the product. This is a stress rating only; functional operation of the product at these or any other conditions above those indicated in the operational section of this specification is not implied. Operation beyond the maximum operating conditions for extended periods may affect product reliability.

**CONTINUOUS WORKING VOLTAGE**Table 18. Maximum Continuous Working Voltage<sup>1</sup>

Parameter	Max	Unit	Constraint
AC Voltage			
Bipolar Waveform	565	V peak	50-year minimum lifetime
Unipolar Waveform	1131	V peak	50-year minimum lifetime
DC Voltage	1131	V peak	50-year minimum lifetime

<sup>1</sup> Refers to continuous voltage magnitude imposed across the isolation barrier. See the Insulation Lifetime section for more details.

**ESD CAUTION****ESD (electrostatic discharge) sensitive device.**

Charged devices and circuit boards can discharge without detection. Although this product features patented or proprietary protection circuitry, damage may occur on devices subjected to high energy ESD. Therefore, proper ESD precautions should be taken to avoid performance degradation or loss of functionality.

PIN CONFIGURATIONS AND FUNCTION DESCRIPTIONS

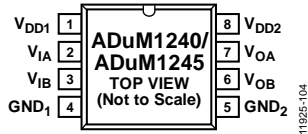

Figure 5. ADuM1240/ADuM1245 8-Lead SOIC (R-8) Pin Configuration

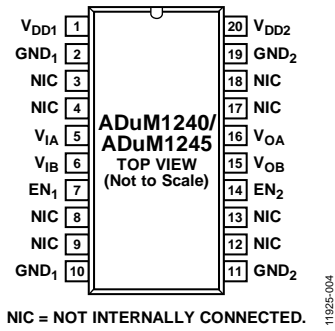

Figure 6. ADuM1240/ADuM1245 20-Lead SSOP (RS-20) Pin Configuration

Table 19. ADuM1240/ADuM1245 8-Lead SOIC (R-8) and 20-Lead SSOP (RS-20) Pin Function Descriptions<sup>1</sup>

8-Lead SOIC Pin No. <sup>2</sup>	20-Lead SSOP Pin No.	Mnemonic	Description
1	1	V <sub>DD1</sub>	Supply Voltage for Isolator Side 1 (2.25 V to 3.6 V). Connect a ceramic bypass capacitor in the range of 0.01 μF to 0.1 μF between V <sub>DD1</sub> and GND <sub>1</sub> .
N/A	2	GND <sub>1</sub>	Ground 1. Ground reference for Isolator Side 1. Pin 2 and Pin 10 are internally connected, and connecting both to GND <sub>1</sub> is recommended.
N/A	3	NIC	Not Internally Connected. Leave this pin floating.
N/A	4	NIC	Not Internally Connected. Leave this pin floating.
2	5	V <sub>IA</sub>	Logic Input A.
3	6	V <sub>IB</sub>	Logic Input B.
N/A	7	EN <sub>1</sub>	Refresh and Watchdog Enable 1. In the 20-lead SSOP package, connecting Pin 7 to GND <sub>1</sub> enables the input/output refresh and watchdog functionality for Side 1, supporting standard iCoupler operation. Tying Pin 7 to V <sub>DD1</sub> disables the refresh and watchdog functionality for the lowest power operation. See the DC Correctness and Low Power Operation section for a description of this mode. EN <sub>1</sub> and EN <sub>2</sub> must be set to the same logic state.
N/A	8	NIC	Not Internally Connected. Leave this pin floating.
N/A	9	NIC	Not Internally Connected. Leave this pin floating.
4	10	GND <sub>1</sub>	Ground 1. Ground reference for Isolator Side 1. In the 20-lead SSOP package, Pin 2 and Pin 10 are internally connected, and connecting both to GND <sub>1</sub> is recommended.
5	11	GND <sub>2</sub>	Ground 2. Ground reference for Isolator Side 2. In the 20-lead SSOP package, Pin 11 and Pin 19 are internally connected, and connecting both to GND <sub>2</sub> is recommended.
N/A	12	NIC	Not Internally Connected. Leave this pin floating.
N/A	13	NIC	Not Internally Connected. Leave this pin floating.
N/A	14	EN <sub>2</sub>	Refresh and Watchdog Enable 2. In the 20-lead SSOP package, connecting Pin 14 to GND <sub>2</sub> enables the input/output refresh and watchdog functionality for Side 2, supporting standard iCoupler operation. Tying Pin 14 to V <sub>DD2</sub> disables the refresh and watchdog functionality for lowest power operation. See the DC Correctness and Low Power Operation section for a description of this mode. EN <sub>1</sub> and EN <sub>2</sub> must be set to the same logic state.
6	15	V <sub>OB</sub>	Logic Output B.
7	16	V <sub>OA</sub>	Logic Output A.
N/A	17	NIC	Not Internally Connected. Leave this pin floating.
N/A	18	NIC	Not Internally Connected. Leave this pin floating.
N/A	19	GND <sub>2</sub>	Ground 2. Ground reference for Isolator Side 2. In the 20-lead SSOP package, Pin 11 and Pin 19 are internally connected, and connecting both to GND <sub>2</sub> is recommended.
8	20	V <sub>DD2</sub>	Supply Voltage for Isolator Side 2 (2.25 V to 3.6 V). Connect a ceramic bypass capacitor in the range of 0.01 μF to 0.1 μF between V <sub>DD2</sub> and GND <sub>2</sub> .

<sup>1</sup> Reference AN-1109 for specific layout guidelines.

<sup>2</sup> N/A means not applicable.

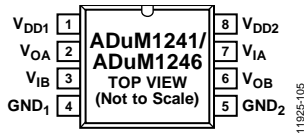

Figure 7. ADuM1241/ADuM1246 8-Lead SOIC (R-8) Pin Configuration



NIC = NOT INTERNALLY CONNECTED.

Figure 8. ADuM1241/ADuM1246 20-Lead SSOP (RS-20) Pin Configuration

Table 20. ADuM1241/ADuM1246 8-Lead SOIC (R-8) and 20-Lead SSOP (RS-20) Pin Function Descriptions<sup>1</sup>

8-Lead SOIC Pin No. <sup>2</sup>	20-Lead SSOP Pin No.	Mnemonic	Description
1	1	V <sub>DD1</sub>	Supply Voltage for Isolator Side 1 (2.25 V to 3.6 V). Connect a ceramic bypass capacitor in the range of 0.01 $\mu$ F to 0.1 $\mu$ F between V <sub>DD1</sub> and GND <sub>1</sub> .
N/A	2	GND <sub>1</sub>	Ground 1. Ground reference for Isolator Side 1. Pin 2 and Pin 10 are internally connected, and connecting both to GND <sub>1</sub> is recommended.
N/A	3	NIC	Not Internally Connected. Leave this pin floating.
N/A	4	NIC	Not Internally Connected. Leave this pin floating.
2	5	V <sub>OA</sub>	Logic Output A.
3	6	V <sub>IB</sub>	Logic Input B.
N/A	7	EN <sub>1</sub>	Refresh and Watchdog Enable 1. In the 20-lead SSOP package, connecting Pin 7 to GND <sub>1</sub> enables the input/output refresh and watchdog functionality for Side 1, supporting standard <i>i</i> Coupler operation. Tying Pin 7 to V <sub>DD1</sub> disables the refresh and watchdog functionality for the lowest power operation. See the DC Correctness and Low Power Operation section for a description of this mode. EN <sub>1</sub> and EN <sub>2</sub> must be set to the same logic state.
N/A	8	NIC	Not Internally Connected. Leave this pin floating.
N/A	9	NIC	Not Internally Connected. Leave this pin floating.
4	10	GND <sub>1</sub>	Ground 1. Ground reference for Isolator Side 1. In the 20-lead SSOP package, Pin 2 and Pin 10 are internally connected, and connecting both to GND <sub>1</sub> is recommended.
5	11	GND <sub>2</sub>	Ground 2. Ground reference for Isolator Side 2. In the 20-lead SSOP package, Pin 11 and Pin 19 are internally connected, and connecting both to GND <sub>2</sub> is recommended.
N/A	12	NIC	Not Internally Connected. Leave this pin floating.
N/A	13	NIC	Not Internally Connected. Leave this pin floating.
N/A	14	EN <sub>2</sub>	Refresh and Watchdog Enable 2. In the 20-lead SSOP package, connecting Pin 14 to GND <sub>2</sub> enables the input/output refresh and watchdog functionality for Side 2, supporting standard <i>i</i> Coupler operation. Tying Pin 14 to V <sub>DD2</sub> disables the refresh and watchdog functionality for lowest power operation. See the DC Correctness and Low Power Operation section for a description of this mode. EN <sub>1</sub> and EN <sub>2</sub> must be set to the same logic state.
6	15	V <sub>OB</sub>	Logic Output B.
7	16	V <sub>IA</sub>	Logic Input A.
N/A	17	NIC	Not Internally Connected. Leave this pin floating.
N/A	18	NIC	Not Internally Connected. Leave this pin floating.
N/A	19	GND <sub>2</sub>	Ground 2. Ground reference for Isolator Side 2. In the 20-lead SSOP package, Pin 11 and Pin 19 are internally connected, and connecting both to GND <sub>2</sub> is recommended.
8	20	V <sub>DD2</sub>	Supply Voltage for Isolator Side 2 (2.25 V to 3.6 V). Connect a ceramic bypass capacitor in the range of 0.01 $\mu$ F to 0.1 $\mu$ F between V <sub>DD2</sub> and GND <sub>2</sub> .

<sup>1</sup> Reference AN-1109 for specific layout guidelines.

<sup>2</sup> N/A means not applicable.

**TRUTH TABLES**

Table 22 provides the truth table (positive logic) for the ADuM1240 and the ADuM1241, and Table 23 provides the truth table (positive logic) for the ADuM1245 and the ADuM1246. For a description of the abbreviations used in the truth tables, see Table 21.

**Table 21. Truth Table Abbreviations**

Letter	Description
H	High level
L	Low level
↑	Rising data transition
↓	Falling data transition
X	Irrelevant
Q <sub>0</sub>	Level of V <sub>OX</sub> prior to levels being established
Z	High impedance

**Table 22. ADuM1240/ADuM1241 Truth Table (Positive Logic)<sup>1, 2, 3</sup>**

V <sub>ix</sub> Input	V <sub>DDI</sub> State	V <sub>DDO</sub> State	EN <sub>x</sub> State	V <sub>Ox</sub> Output	Description
H	Powered	Powered	L	H	Normal operation; data is high and refresh is enabled.
L	Powered	Powered	L	L	Normal operation; data is low and refresh is enabled.
X	Unpowered	Powered	L	H	Input unpowered. Outputs are in the default high state. Outputs return to the input state within 150 μs of V <sub>DDI</sub> power restoration. See the pin function descriptions (Table 19 and Table 20) for details.
X	Unpowered	Powered	H	Q <sub>0</sub>	Input unpowered. Outputs are static at the level that was last sent from the input or at the power-up level. See the pin function descriptions (Table 19 and Table 20) for details.
□	Powered	Powered	H	H	Output is high after propagation delay, refresh is disabled.
□	Powered	Powered	H	L	Output is low after propagation delay, refresh is disabled.
X	Powered	Unpowered	X	Z	Output unpowered. Output pins are in high impedance state. Outputs return to the input state within 150 μs of V <sub>DDO</sub> power restoration. See the pin function descriptions (Table 19 and Table 20) for details.

<sup>1</sup> V<sub>ix</sub> and V<sub>Ox</sub> refer to the input and output signals of a given channel (A, B, C, or D).

<sup>2</sup> V<sub>DDI</sub> refers to the power supply on the input side of a given channel (A, B, C, or D).

<sup>3</sup> V<sub>DDO</sub> refers to the power supply on the output side of a given channel (A, B, C, or D).

**Table 23. ADuM1245/ADuM1246 Truth Table (Positive Logic)<sup>1, 2, 3</sup>**

V <sub>ix</sub> Input	V <sub>DDI</sub> State	V <sub>DDO</sub> State	EN <sub>x</sub> State	V <sub>Ox</sub> Output	Description
H	Powered	Powered	L	H	Normal operation; data is high and refresh is enabled.
L	Powered	Powered	L	L	Normal operation; data is low and refresh is enabled.
X	Unpowered	Powered	L	L	Input unpowered. Outputs are in the default low state. Outputs return to the input state within 150 μs of V <sub>DDI</sub> power restoration. See the pin function descriptions (Table 19 and Table 20) for details.
X	Unpowered	Powered	H	Q <sub>0</sub>	Input unpowered. Outputs are static at the level that was last sent from the input or at the power-up level. See the pin function descriptions (Table 19 and Table 20) for details.
□	Powered	Powered	H	H	Output is high, refresh is disabled.
□	Powered	Powered	H	L	Output is low, refresh is disabled.
X	Powered	Unpowered	X	Z	Output unpowered. Output pins are in high impedance state. Outputs return to input state within 150 μs of V <sub>DDO</sub> power restoration. See the pin function descriptions (Table 19 and Table 20) for details.

<sup>1</sup> V<sub>ix</sub> and V<sub>Ox</sub> refer to the input and output signals of a given channel (A, B, C, or D).

<sup>2</sup> V<sub>DDI</sub> refers to the power supply on the input side of a given channel (A, B, C, or D).

<sup>3</sup> V<sub>DDO</sub> refers to the power supply on the output side of a given channel (A, B, C, or D).

TYPICAL PERFORMANCE CHARACTERISTICS



Figure 9. Current Consumption per Input vs. Data Rate for 2.5 V, EN<sub>x</sub> = Low Operation

11925-006



Figure 12. Current Consumption per Output vs. Data Rate for 3.3 V, EN<sub>x</sub> = Low Operation

11925-009



Figure 10. Current Consumption per Output vs. Data Rate for 2.5 V, EN<sub>x</sub> = Low Operation

11925-007



Figure 13. Current Consumption per Input vs. Data Rate for 2.5 V, EN<sub>x</sub> = High Operation

11925-010



Figure 11. Current Consumption per Input vs. Data Rate for 3.3 V, EN<sub>x</sub> = Low Operation

11925-008



Figure 14. Current Consumption per Output vs. Data Rate for 2.5 V, EN<sub>x</sub> = High Operation

11925-011



Figure 15. Current Consumption per Input vs. Data Rate for  $V_{DDx} = 3.3\text{ V}$ ,  $EN_x = \text{High Operation}$

11925-012

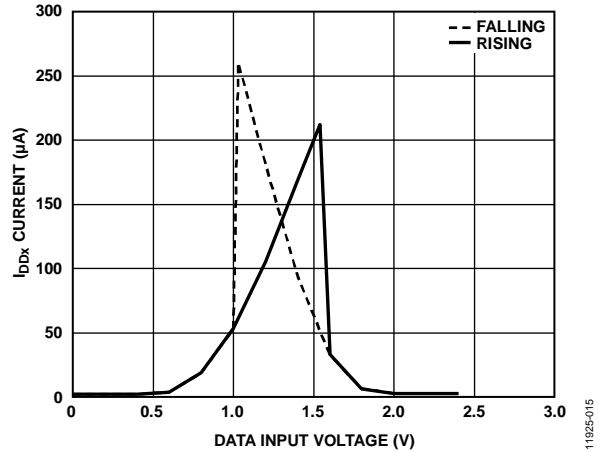

Figure 18.  $I_{DDx}$  Current per Input vs. Data Input Voltage for  $V_{DDx} = 2.5\text{ V}$

11925-015



Figure 16. Current Consumption per Output vs. Data Rate for  $V_{DDx} = 3.3\text{ V}$ ,  $EN_x = \text{High Operation}$

11925-013

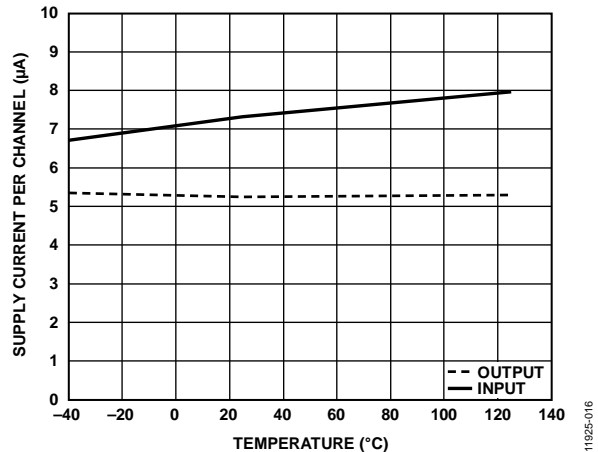

Figure 19. Typical Input and Output Supply Current per Channel vs. Temperature for  $V_{DDx} = 2.5\text{ V}$ , Data Rate = 100 kbps

11925-016



Figure 17. Typical  $I_{DDx}$  Current per Input vs. Data Input Voltage for  $V_{DDx} = 3.3\text{ V}$

11925-014

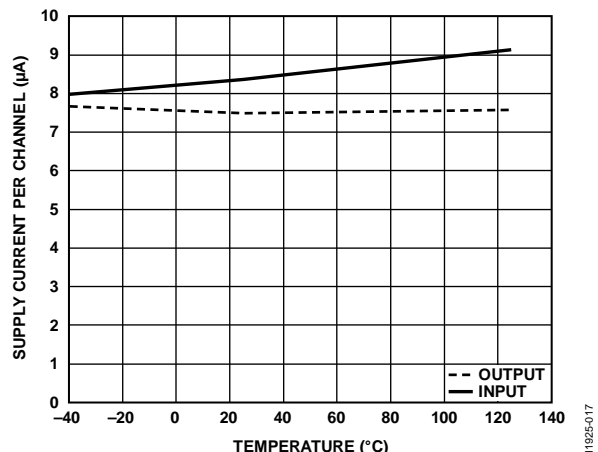

Figure 20. Typical Input and Output Supply Current per Channel vs. Temperature for  $V_{DDx} = 3.3\text{ V}$ , Data Rate = 100 kbps

11925-017



Figure 21. Typical Input and Output Supply Current per Channel vs. Temperature for  $V_{DDx} = 2.5\text{ V}$ , Data Rate = 1000 kbps



Figure 24. Typical Glitch Filter Operation Threshold



Figure 22. Typical Input and Output Supply Current per Channel vs. Temperature for  $V_{DDx} = 3.3\text{ V}$ , Data Rate = 1000 kbps



Figure 25. Typical Refresh Period vs. Temperature for 3.3 V and 2.5 V Operation



Figure 23. Typical Propagation Delay vs. Temperature for  $V_{DDx} = 3.3\text{ V}$  or  $V_{DDx} = 2.5\text{ V}$



Figure 26. Typical Refresh Period vs.  $V_{DDx}$  Voltage



## APPLICATIONS INFORMATION

### PCB LAYOUT

The [ADuM1240/ADuM1241/ADuM1245/ADuM1246](#) digital isolators require no external interface circuitry for the logic interfaces. Power supply bypassing is strongly recommended at both the input and output supply pins:  $V_{DD1}$  and  $V_{DD2}$  (see Figure 27). Maintain the capacitor value between 0.01  $\mu\text{F}$  and 0.1  $\mu\text{F}$  and for best results, ensure that the total lead length between both ends of the capacitor and the input power supply does not exceed 20 mm.

With proper PCB design choices, these digital isolators readily meet CISPR 22 Class A (and FCC Class A) emissions standards, as well as the more stringent CISPR 22 Class B (and FCC Class B) standards in an unshielded environment. Refer to [AN-1109](#) for PCB related electromagnetic interference (EMI) mitigation techniques, including board layout and stack up issues.



NIC = NOT INTERNALLY CONNECTED.

Figure 27. Recommended PCB Layout, 20-Lead SSOP (RS-20)



Figure 28. Recommended PCB Layout, 8-Lead SOIC (R-8)

For applications involving high common-mode transients, it is important to minimize board coupling across the isolation barrier. Furthermore, design the board layout so that any coupling that does occur equally affects all pins on a given component side. Failure to ensure this equal capacitive coupling of pins can cause voltage differentials between pins exceeding the absolute maximum ratings of the device, thereby leading to latch-up or permanent damage.

### PROPAGATION DELAY RELATED PARAMETERS

Propagation delay is a parameter that describes the time it takes a logic signal to propagate through a component. The input to output propagation delay time for a high to low transition can differ from the propagation delay time of a low to high transition.

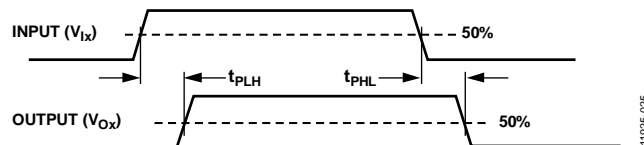

Figure 29. Propagation Delay Parameters

Pulse width distortion is the maximum difference between these two propagation delay values, and an indication of how accurately the timing of the input signal is preserved.

Channel to channel matching refers to the maximum amount the propagation delay differs between channels within a single component of the [ADuM1240/ADuM1241/ADuM1245/ADuM1246](#).

Propagation delay skew refers to the maximum amount the propagation delay differs between multiple [ADuM1240/ADuM1241/ADuM1245/ADuM1246](#) components operating under the same conditions.

### DC CORRECTNESS AND LOW POWER OPERATION

#### Standard Operating Mode

Positive and negative logic transitions at the isolator input cause narrow ( $\sim 1$  ns) pulses to be sent to the decoder using the transformer. The decoder is bistable and is, therefore, either set or reset by the pulses, indicating input logic transitions. When refresh and watchdog functions are enabled, by pulling  $EN_1$  and  $EN_2$  low, in the absence of logic transitions at the input for more than  $\sim 140 \mu\text{s}$ , a periodic set of refresh pulses, indicative of the correct input state, is sent to ensure dc correctness at the output. If the decoder receives no internal pulses of more than approximately 200  $\mu\text{s}$ , the device assumes that the input side is unpowered or nonfunctional, in which case, the isolator watchdog circuit forces the output to a default state. The default state is either high, as in the [ADuM1240](#) and [ADuM1241](#) versions, or low, as in the [ADuM1245](#) and [ADuM1246](#) versions.

#### Low Power Operating Mode

For the lowest power consumption, disable the refresh and watchdog functions of the [ADuM1240/ADuM1241/ADuM1245/ADuM1246](#) by pulling  $EN_1$  and  $EN_2$  to logic high. These control pins must be set to the same value on each side of the component for proper operation.

In this mode, the current consumption of the chip drops to the microampere range. However, be careful when using this mode, because dc correctness is no longer guaranteed at startup. For example, if the following sequence of events occurs:

1. Power is applied to Side 1.
2. A high level is asserted on the  $V_{IA}$  input.
3. Power is applied to Side 2.

The high on  $V_{IA}$  is not automatically transferred to the Side 2  $V_{OA}$ , and there can be a level mismatch that is not corrected until a transition occurs at  $V_{IA}$ . When power is stable on each side, and a transition occurs on the input of the channel, the input and output state of that channel is correctly matched. This contingency can be resolved in several ways, such as sending dummy data, or toggling refresh on for a short period to force synchronization after turn on.

**Recommended Input Voltage for Low Power Operation**

The ADuM1240/ADuM1241/ADuM1245/ADuM1246 implement Schmitt trigger input buffers so that the devices operate cleanly in low data rate, or in noisy environments. Schmitt triggers allow a small amount of shoot through current when the input voltage is not approximate to either  $V_{DDx}$  or  $GND_x$  levels. Shoot through is possible because the two transistors are both slightly on when input voltages are in the middle of the supply range. For many digital devices, this leakage is not a large portion of the total supply current and cannot be noticed; however, in the ultralow power

ADuM1240/ADuM1241/ADuM1245/ADuM1246, this leakage can be larger than the total operating current of the device and must not be ignored.

To achieve optimum power consumption with the ADuM1240/ADuM1241/ADuM1245/ADuM1246, always drive the inputs as near to  $V_{DDx}$  or  $GND_x$  levels as possible. Figure 17 and Figure 18 illustrate the shoot through leakage of an input; therefore, whereas the logic thresholds of the input are standard CMOS levels, optimum power performance is achieved when the input logic levels are driven within 0.5 V of either  $V_{DDx}$  or  $GND_x$  levels.

**MAGNETIC FIELD IMMUNITY**

The limitation on the magnetic field immunity of the device is set by the condition in which, induced voltage in the transformer receiving coil is sufficiently large, to either falsely set or reset the decoder. The following analysis defines such conditions. The ADuM1240 is examined in a 3 V operating condition, because it represents the typical mode of operation for these products.

The pulses at the transformer output have an amplitude greater than 1.5 V. The decoder has a sensing threshold of about 1.0 V, therefore establishing a 0.5 V margin in which induced voltages are tolerated. The voltage induced across the receiving coil is given by

$$V = (-d\beta/dt)\sum\pi r_n^2; n = 1, 2, \dots, N$$

where:

$\beta$  is the magnetic flux density.

$r_n$  is the radius of the  $n^{th}$  turn in the receiving coil.

$N$  is the number of turns in the receiving coil.

Given the geometry of the receiving coil in the ADuM1240, and an imposed requirement that the induced voltage be, at most, 50% of the 0.5 V margin at the decoder, a maximum allowable magnetic field is calculated as shown in Figure 30.



Figure 30. Maximum Allowable External Magnetic Flux Density

For example, at a magnetic field frequency of 1 MHz, the maximum allowable magnetic field of 0.5 kgauss induces a voltage of 0.25 V at the receiving coil. This is about 50% of the sensing threshold and does not cause a faulty output transition. If such an event occurs, with the worst case polarity, during a transmitted pulse, it would reduce the received pulse from >1.0 V to 0.75 V. This is still higher than the 0.5 V sensing threshold of the decoder.

The preceding magnetic flux density values correspond to specific current magnitudes at given distances away from the ADuM1240 transformers. Figure 31 expresses these allowable current magnitudes as a function of frequency for selected distances. The ADuM1240 is very insensitive to external fields. Only extremely large, high frequency currents, very close to the component, could potentially be a concern. For the 1 MHz example noted, the user would have to place a 1.2 kA current 5 mm away from the ADuM1240 to affect component operation.



Figure 31. Maximum Allowable Current for Various Currents to ADuM1240 Spacings

Note that at combinations of strong magnetic field and high frequency, any loops formed by PCB traces could induce sufficiently large error voltages to trigger the thresholds of succeeding circuitry. Avoid PCB structures that form loops.

## POWER CONSUMPTION

The supply current with refresh enabled at a given channel of the [ADuM1240/ADuM1241/ADuM1245/ADuM1246](#) isolators, is a function of the supply voltage, the data rate of the channel, and the output load of the channel.

For each input channel, the supply current is given by

$$I_{DDI} = I_{DDI(Q)} \quad f \leq 0.5 f_r$$

$$I_{DDI} = I_{DDI(D)} \times (2f - f_r) + I_{DDI(Q)} \quad f > 0.5 f_r$$

For each output channel, the supply current is given by

$$I_{DDO} = I_{DDO(Q)} \quad f \leq 0.5 f_r$$

$$I_{DDO} = (I_{DDO(D)} + (0.5 \times 10^{-3}) \times C_L \times V_{DDO}) \times (2f - f_r) + I_{DDO(Q)} \quad f > 0.5 f_r$$

where:

$I_{DDI(D)}$  and  $I_{DDO(D)}$  are the input and output dynamic supply currents per channel (mA/Mbps).

$C_L$  is the output load capacitance (pF).

$V_{DDO}$  is the output supply voltage (V).

$f$  is the input logic signal frequency (MHz); it is half the input data rate, expressed in units of Mbps.

$f_r$  is the input stage refresh rate (Mbps) =  $1/T_r$  ( $\mu$ s).

$I_{DDI(Q)}$  and  $I_{DDO(Q)}$  are the specified input and output quiescent supply currents (mA).

To calculate the total  $V_{DD1}$  and  $V_{DD2}$  supply current, the supply currents for each input and output channel corresponding to  $V_{DD1}$  and  $V_{DD2}$  are calculated and totaled. Figure 9 through Figure 16 show per channel supply currents as a function of data rate for an unloaded output condition.

## INSULATION LIFETIME

All insulation structures eventually degrade, when subjected to voltage stress for a sufficiently long period. The rate of insulation degradation is dependent on the characteristics of the voltage waveform applied across the insulation. In addition to the testing performed by the regulatory agencies, Analog Devices carries out an extensive set of evaluations to determine the lifetime of the insulation structure within the

[ADuM1240/ADuM1241/ADuM1245/ADuM1246](#).

Analog Devices performs accelerated life testing using voltage levels higher than the rated continuous working voltage. Acceleration factors for several operating conditions are determined. These factors allow calculation of the time to failure at the actual working voltage.

The values shown in Table 18 summarize the peak voltage for 50 years of service life for a bipolar ac operating condition, and the maximum CSA/VDE approved working voltages. In many cases, the approved working voltage is higher than 50-year service life voltage. Operation at these high working voltages can lead to shortened insulation life, in some cases.

The insulation lifetime of the [ADuM1240/ADuM1241/ADuM1245/ADuM1246](#) depends on the voltage waveform type imposed across the isolation barrier. The *iCoupler* insulation structure degrades at different rates, depending on whether the waveform is bipolar ac, unipolar ac, or dc. Figure 19, Figure 20, and Figure 21 illustrate these different isolation voltage waveforms.

Bipolar ac voltage is the most stringent environment. The goal of a 50-year operating lifetime, under the ac bipolar condition, determines the Analog Devices recommended maximum working voltage.

In the case of unipolar ac or dc voltage, the stress on the insulation is significantly lower. This allows operation at higher working voltages, while still achieving a 50-year service life. The working voltages listed in Table 18 can be applied while maintaining the 50-year minimum lifetime, provided the voltages conform to either the unipolar ac or dc voltage case. Treat any cross-insulation voltage waveform that does not conform to Figure 33 or Figure 34 as a bipolar ac waveform, and limit peak voltage to the 50-year lifetime voltage value listed in Table 18.

Note that the voltage presented in Figure 33 is shown as sinusoidal for illustration purposes only. It represents any voltage waveform varying between 0 V and some limiting value. The limiting value can be positive or negative, but the voltage must not cross 0 V.



Figure 32. Bipolar AC Waveform



Figure 33. Unipolar AC Waveform



Figure 34. DC Waveform

OUTLINE DIMENSIONS



COMPLIANT TO JEDEC STANDARDS MS-012-AA  
 CONTROLLING DIMENSIONS ARE IN MILLIMETERS; INCH DIMENSIONS  
 (IN PARENTHESES) ARE ROUNDED-OFF MILLIMETER EQUIVALENTS FOR  
 REFERENCE ONLY AND ARE NOT APPROPRIATE FOR USE IN DESIGN.

012407-A

Figure 35. 8-Lead Standard Small Outline Package [SOIC\_N]  
 Narrow Body  
 (R-8)

Dimensions shown in millimeters and (inches)



COMPLIANT TO JEDEC STANDARDS MO-150-AE

Figure 36. 20-Lead Shrink Small Outline Package [SSOP]  
 (RS-20)

Dimensions shown in millimeters

060106-A

## ORDERING GUIDE

Model <sup>1, 2</sup>	No. of Inputs, V <sub>DD1</sub> Side	No. of Inputs, V <sub>DD2</sub> Side	Maximum Data Rate (Mbps)	Maximum Propagation Delay, 3.3 V	Output Default State	Temperature Range	Package Description	Package Option
ADuM1240ARZ	2	0	2	180	High	−40°C to +125°C	8-Lead SOIC_N	R-8
ADuM1240ARZ-RL7	2	0	2	180	High	−40°C to +125°C	8-Lead SOIC_N	R-8
ADuM1240ARSZ	2	0	2	180	High	−40°C to +125°C	20-Lead SSOP	RS-20
ADuM1240ARSZ-RL7	2	0	2	180	High	−40°C to +125°C	20-Lead SSOP	RS-20
ADuM1241ARZ	1	1	2	180	High	−40°C to +125°C	8-Lead SOIC_N	R-8
ADuM1241ARZ-RL7	1	1	2	180	High	−40°C to +125°C	8-Lead SOIC_N	R-8
ADuM1241ARSZ	1	1	2	180	High	−40°C to +125°C	20-Lead SSOP	RS-20
ADuM1241ARSZ-RL7	1	1	2	180	High	−40°C to +125°C	20-Lead SSOP	RS-20
ADuM1245ARZ	2	0	2	180	Low	−40°C to +125°C	8-Lead SOIC_N	R-8
ADuM1245ARZ-RL7	2	0	2	180	Low	−40°C to +125°C	8-Lead SOIC_N	R-8
ADuM1245ARSZ	2	0	2	180	Low	−40°C to +125°C	20-Lead SSOP	RS-20
ADuM1245ARSZ-RL7	2	0	2	180	Low	−40°C to +125°C	20-Lead SSOP	RS-20
ADuM1246ARZ	1	1	2	180	Low	−40°C to +125°C	8-Lead SOIC_N	R-8
ADuM1246ARZ-RL7	1	1	2	180	Low	−40°C to +125°C	8-Lead SOIC_N	R-8
ADuM1246ARSZ	1	1	2	180	Low	−40°C to +125°C	20-Lead SSOP	RS-20
ADuM1246ARSZ-RL7	1	1	2	180	Low	−40°C to +125°C	20-Lead SSOP	RS-20

<sup>1</sup> Z = RoHS Compliant Part.

<sup>2</sup> Tape and reel is available. The addition of the -RL7 suffix indicates that the product is shipped on 7" tape and reel.

**NOTES**

**NOTES**

NOTES