

Overview

KEMET's ALC40 Series of snap-in capacitors features the same high ripple currents and long-life characteristics as the ALC10 Series but can operate at higher temperatures.

Applications

KEMET's ALC40 capacitors are suited for high reliability and long life applications such as frequency converters, uninterruptible power supply (UPS) systems and switch mode power supplies (SMPS). The extended temperature range allows increased ripple currents at lower temperatures.

Benefits

- Compact size
- Long life, up to 9,000 hours at +105°C (V_R , I_R applied)
- High ripple current
- Excellent surge voltage capability
- Optimized designs available upon request

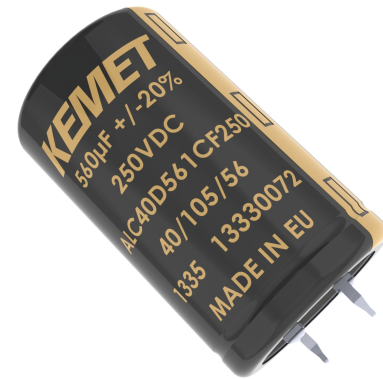

Part Number System

ALC40	A	822	BB	025	
Series	Termination	Capacitance Code (µF)	Size Code	Rated Voltage (VDC)	
Snap-In Aluminum Electrolytic	See Termination Table	First two digits represent significant figures. Third digit specifies number of zeros.	See Dimension Table	025 = 25 040 = 40 063 = 63 100 = 100 200 = 200	250 = 250 350 = 350 400 = 400 450 = 450 500 = 500

Performance Characteristics

Item	Performance Characteristics		
Capacitance Range	47 – 120,000 μ F		
Rated Voltage	25 – 500 VDC		
Operating Temperature	–40 to +105°C		
Storage Temperature Range	–55 to +105°C		
Capacitance Tolerance	\pm 20% at 100 Hz/+20°C		
Operational Lifetime	D (mm)	Rated Voltage and Ripple Current at +105°C (hours)	Rated Voltage at +105°C (hours)
	25	6,000	10,000
	30	7,000	11,000
	35	8,000	13,000
	40 – 50	9,000	14,000
End of Life Requirement	Δ C/C < \pm 10%, ESR < 2 x initial ESR value, IL < initial specified limit		
Shelf Life	2,000 hours at +85°C or 30,000 hours at +40°C 0 VDC		
Leakage Current	I = 0.003 CV or 6,000 (μ A, whichever is smaller)		
	C = rated capacitance (μ F), V = rated voltage (VDC). Voltage applied for 5 minutes at +20°C.		
Vibration Test Specifications		Procedure	Requirements
	D \leq 40 mm	0.75 mm displacement amplitude or 10 G maximum acceleration. Vibration applied for three 2-hour sessions at 10 – 500 Hz (Capacitor clamped by body).	No leakage of electrolyte or other visible damage. Deviations in capacitance from initial measurements must not exceed: Δ C/C < 5%
D > 40 mm	0.35 mm displacement amplitude or 5 G maximum acceleration. Vibration applied for three 0.5-hour sessions at 10 – 55 Hz (Capacitor clamped by body).		
Standards	IEC 60384–4 long life grade 40/105/56		

Surge Voltage

Condition	Voltage (VDC)									
	25	40	63	100	200	250	350	400	450	500
\leq 30s Surge followed by a no load period of 330s, 1,000 cycles at +85°C	28.75	46	72.5	115	230	288	385	440	495	550

Test Method & Performance

Endurance Life Test		
Conditions	Performance	
Temperature	+105°C	
Test Duration	5,000 hours	
Ripple Current	Rated ripple current in specified table	
Voltage	The sum of DC voltage and the peak AC voltage must not exceed the rated voltage of the capacitor	
Performance	The following specifications will be satisfied when the capacitor is tested at +20°C:	
Capacitance Change	≤ 160 V	Within 15% of the initial value
	> 160 V	Within 10% of the initial value
Equivalent Series Resistance	Does not exceed 200% of the initial value	
Leakage Current	Does not exceed leakage current limit	

Dimensions – Millimeters

Size Code	Dimensions in mm		Approximate Weight Grams
	D	L	
	-0/+1	±2	
BB	25	30	28
BC	25	35	30
BD	25	40	35
CB	30	30	35
CC	30	35	40
CD	30	40	45
CE	30	45	50
CF	30	50	55
DB	35	30	42
DC	35	35	50
DD	35	40	55
DE	35	45	65
DF	35	50	70
DG	35	55	75
DH	35	60	80
DL	35	80	105
EB	40	30	49
EC	40	35	57
ED	40	40	65
EE	40	45	80
EF	40	50	82
EG	40	55	95

Note: Dimensions include sleeving

Size Code	Dimensions in mm		Approximate Weight Grams
	D	L	
	-0/+1	±2	
EH	40	60	98
EL	40	80	131
EP	40	105	170
FB	45	30	62
FC	45	35	72
FD	45	40	82
FE	45	45	92
FF	45	50	103
FG	45	55	113
FH	45	60	123
FL	45	80	164
FP	45	105	215
KB	50	30	75
KC	50	35	88
KD	50	40	100
KE	50	45	113
KF	50	50	126
KG	50	55	138
KH	50	60	151
KL	50	80	201
KP	50	105	264

Note: Dimensions include sleeving

Termination Tables

Termination Code	A	D	F	C	E	G	H
Diameter (mm)							
25	•	•	•				
30	•	•	•				
35	•	•	•	•	•		
40	•	•	•	•	•	•	•
45				•	•	•	•
50				•	•	•	•

Mounting: These capacitors are designed to be mounted by their terminations alone and may be used in any position. Dummy pins must be isolated on 4 and 5 pin styles.

Termination Code	Termination Style	LL
		±1
Standard Termination Option		
A	2 Pin	6.3
G (D ≥ 45)	5 Pin	6.3
Other Termination Options		
D	2 Pin	4.0
F	3 Pin	4.0
C	4 Pin	6.3
E	4 Pin	4.0
H	5 Pin	4.0

Dimensions in mm

Termination Tables cont.

Style A/D

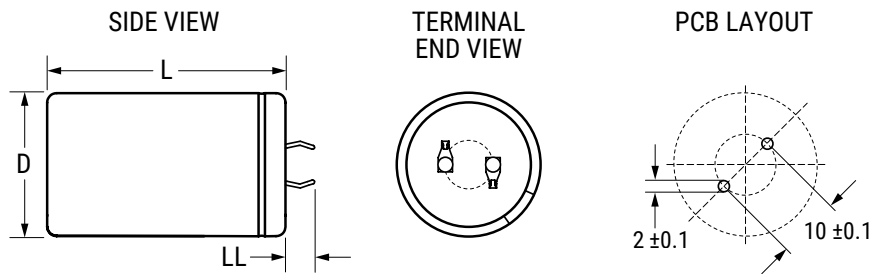

Style F

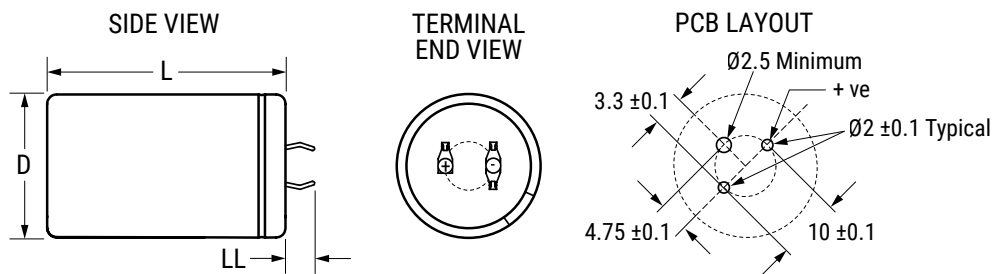

Style C/E

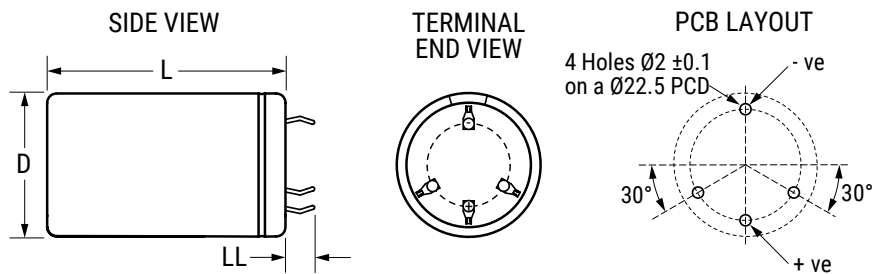

Style G/H

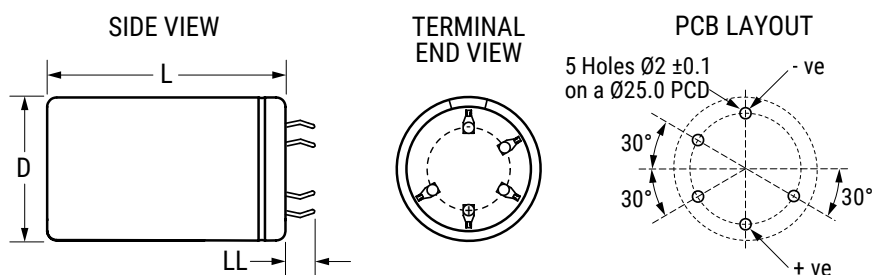

Shelf Life

The capacitance, ESR and impedance of a capacitor will not change significantly after extended storage periods, however the leakage current will very slowly increase. KEMET products are particularly stable and allow a shelf life in excess of three years at 40°C. See sectional specification under each product series for specific data.

Re-age (Reforming) Procedure

Apply the rated voltage to the capacitor at room temperature for a period of one hour, or until the leakage current has fallen to a steady value below the specified limit. During re-aging a maximum charging current of twice the specified leakage current or 5 mA (whichever is greater) is suggested.

Reliability

The reliability of a component can be defined as the probability that it will perform satisfactorily under a given set of conditions for a given length of time.

In practice, it is impossible to predict with absolute certainty how any individual component will perform; thus, we must utilize probability theory. It is also necessary to clearly define the level of stress involved (e.g. operating voltage, ripple current, temperature and time). Finally, the meaning of satisfactory performance must be defined by specifying a set of conditions which determine the end of life of the component.

Reliability as a function of time, $R(t)$, is normally expressed as: $R(t) = e^{-\lambda t}$

where $R(t)$ is the probability that the component will perform satisfactorily for time t , and λ is the failure rate.

Failure Rate

The failure rate is the number of components failing per unit time. The failure rate of most electronic components follows the characteristic pattern:

- Early failures are removed during the manufacturing process.
- The operational life is characterized by a constant failure rate.
- The wear out period is characterized by a rapidly increasing failure rate.

The failures in time (FIT) are given with a 60% confidence level for the various type codes. By convention, FIT is expressed as 1×10^{-9} failures per hour. Failure rate is also expressed as a percentage of failures per 1,000 hours.

e.g., 100 FIT = 1×10^{-7} failures per hour = 0.01%/1,000 hours

End of Life Definition

Catastrophic Failure: short circuit, open circuit or safety vent operation

Parametric Failure:

- Change in capacitance $> \pm 10\%$
- Leakage current $>$ specified limit
- ESR $> 2 \times$ initial ESR value

MTBF

The mean time between failures (MTBF) is simply the inverse of the failure rate.

$$MTBF = 1/\lambda$$



The failure rate is derived from our periodic test results. The failure rate (λ_R) is, therefore, only given at test temperature for life tests. An estimation is also given at 40°C. The expected failure rate for this capacitor range is based on our periodic test results for capacitors with structural similarity. Failure rate is frequently quoted in FIT (Failures In Time) where 1 FIT = 1×10^{-9} failures per hour. Failure rate per hour includes both catastrophic and parametric failures.

T_a	Failure Rate per Hour
85°C	250 FIT
40°C	12 FIT

Environmental Compliance



All Part Numbers in this datasheet are Reach and RoHS compliant.

As an environmentally conscious company, KEMET is working continuously with improvements concerning the environmental effects of both our capacitors and their production.

In Europe (RoHS Directive) and in some other geographical areas such as China, legislation has been put in place to prevent the use of some hazardous materials, such as lead (Pb), in electronic equipment. All products in this catalog are produced to help our customers' obligations to guarantee their products and fulfill these legislative requirements. The only material of concern in our products has been lead (Pb), which has been removed from all designs to fulfill the requirement of containing less than 0.1% of lead in any homogeneous material. KEMET will closely follow any changes in legislation worldwide and make any necessary changes in its products, whenever needed.

Some customer segments such as medical, military and automotive electronics may still require the use of lead in electrode coatings. To clarify the situation and distinguish products from each other, a special symbol is used on the packaging labels for RoHS compatible capacitors.

Due to customer requirements, there may appear additional markings such as lead-free (LF), or lead-free wires (LFW) on the label.

Table 1 – Ratings & Part Number Reference

VDC	Rated Capacitance	Size Code	Case Size	Ripple Current		ESR Maximum	Impedance Maximum	Part Number
	100 Hz 20°C (µF)		D x L (mm)	100 Hz 105°C (A)	10 kHz 105°C (A)	100 Hz 20°C (mΩ)	10 kHz 20°C (mΩ)	
25	8200	BB	25 x 30	1.97	2.11	183	157	ALC40(1)822BB025
25	10000	BC	25 x 35	2.33	2.50	148	126	ALC40(1)103BC025
25	12000	BD	25 x 40	2.74	2.93	123	105	ALC40(1)123BD025
25	12000	CB	30 x 30	2.18	2.33	157	138	ALC40(1)123CB025
25	15000	CC	30 x 35	2.65	2.83	125	109	ALC40(1)153CC025
25	18000	CD	30 x 40	3.04	3.24	103	91	ALC40(1)183CD025
25	22000	DC	35 x 35	2.91	3.10	116	104	ALC40(1)223DC025
25	27000	CF	30 x 50	3.94	4.21	73	64	ALC40(1)273CF025
25	27000	DD	35 x 40	3.34	3.56	96	86	ALC40(1)273DD025
25	27000	EB	40 x 30	4.03	4.09	75	69	ALC40(1)273EB025
25	33000	DF	35 x 50	4.32	4.61	70	63	ALC40(1)333DF025
25	33000	EC	40 x 35	4.83	4.90	66	62	ALC40(1)333EC025
25	39000	DF	35 x 50	4.32	4.61	69	62	ALC40(1)393DF025
25	39000	ED	40 x 40	5.57	5.65	53	49	ALC40(1)393ED025
25	47000	EF	40 x 50	7.30	7.40	41	37	ALC40(1)473EF025
25	56000	EG	40 x 55	7.51	7.61	38	35	ALC40(1)563EG025
25	82000	EL	40 x 80	11.06	11.24	22	20	ALC40(1)823EL025
25	120000	EP	40 x 105	13.41	14.05	18	17	ALC40(1)124EP025
40	3900	BB	25 x 30	1.87	2.09	202	166	ALC40(1)392BB040
40	5600	BC	25 x 35	2.23	2.49	149	124	ALC40(1)562BC040
40	5600	CB	30 x 30	2.08	2.31	171	144	ALC40(1)562CB040
40	6800	BD	25 x 40	2.61	2.92	123	102	ALC40(1)682BD040
40	6800	CC	30 x 35	2.55	2.84	145	120	ALC40(1)682CC040
40	8200	CC	30 x 35	2.53	2.81	129	110	ALC40(1)822CC040
40	10000	CD	30 x 40	2.90	3.22	107	91	ALC40(1)103CD040
40	12000	CF	30 x 50	3.75	4.18	80	68	ALC40(1)123CF040
40	12000	DC	35 x 35	2.77	3.08	121	106	ALC40(1)123DC040
40	12000	EB	40 x 30	4.13	4.22	88	79	ALC40(1)123EB040
40	15000	DD	35 x 40	3.18	3.53	100	87	ALC40(1)153DD040
40	15000	ED	40 x 40	5.66	5.78	63	56	ALC40(1)153ED040
40	18000	DF	35 x 50	4.12	4.58	73	64	ALC40(1)183DF040
40	18000	EE	40 x 45	6.46	6.60	53	47	ALC40(1)183EE040
40	22000	EF	40 x 50	7.34	7.50	43	39	ALC40(1)223EF040
40	27000	EG	40 x 55	7.50	7.63	39	35	ALC40(1)273EG040
40	47000	EL	40 x 80	10.42	10.59	23	21	ALC40(1)473EL040
40	68000	EP	40 x 105	12.71	13.47	17	16	ALC40(1)683EP040
63	2200	BB	25 x 30	1.69	1.98	227	180	ALC40(1)222BB063
63	3300	BC	25 x 35	2.01	2.35	165	133	ALC40(1)332BC063
63	3900	BD	25 x 40	2.36	2.75	138	111	ALC40(1)392BD063
63	3900	CB	30 x 30	1.88	2.18	185	154	ALC40(1)392CB063
63	4700	CC	30 x 35	2.28	2.65	148	123	ALC40(1)472CC063
63	5600	CD	30 x 40	2.61	3.03	122	102	ALC40(1)562CD063
63	5600	EB	40 x 30	3.82	3.91	102	90	ALC40(1)562EB063
63	6800	CF	30 x 50	3.39	3.93	92	75	ALC40(1)682CF063
63	6800	DC	35 x 35	2.50	2.90	141	119	ALC40(1)682DC063
63	6800	EC	40 x 35	4.18	4.26	91	81	ALC40(1)682EC063
63	8200	CF	30 x 50	3.33	3.98	48	35	ALC40(1)822CF063
63	8200	DD	35 x 40	2.87	3.33	116	99	ALC40(1)822DD063
63	8200	ED	40 x 40	5.01	5.12	72	64	ALC40(1)822ED063
63	10000	DF	35 x 50	3.71	4.31	85	72	ALC40(1)103DF063
63	10000	EE	40 x 45	5.69	5.81	60	53	ALC40(1)103EE063
63	12000	EF	40 x 50	6.50	6.64	50	44	ALC40(1)123EF063
63	15000	EH	40 x 60	7.81	7.99	39	34	ALC40(1)153EH063
63	22000	EL	40 x 80	9.70	9.92	27	24	ALC40(1)223EL063
63	33000	EP	40 x 105	12.01	13.01	18	17	ALC40(1)333EP063
100	820	BB	25 x 30	1.39	1.82	294	220	ALC40(1)821BB100
100	1000	BC	25 x 35	1.65	2.16	238	177	ALC40(1)102BC100
100	1200	BD	25 x 40	1.93	2.53	198	147	ALC40(1)122BD100
100	1200	CB	30 x 30	1.57	2.01	245	191	ALC40(1)122CB100
VDC	Rated Capacitance	Size Code	Case Size	Ripple Current		ESR	Impedance	Part Number

(1) Termination code: See Termination Tables for available options.

Table 1 – Ratings & Part Number Reference cont.

VDC	Rated Capacitance	Size Code	Case Size	Ripple Current		ESR Maximum	Impedance Maximum	Part Number
	100 Hz 20°C (µF)		D x L (mm)	100 Hz 105°C (A)	10 kHz 105°C (A)	100 Hz 20°C (mΩ)	10 kHz 20°C (mΩ)	
100	1500	CC	30 x 35	1.90	2.44	195	151	ALC40(1)152CC100
100	1800	CD	30 x 40	2.18	2.80	162	125	ALC40(1)182CD100
100	2200	CF	30 x 50	2.82	3.63	123	94	ALC40(1)222CF100
100	2200	DC	35 x 35	2.10	2.67	177	142	ALC40(1)222DC100
100	2200	DE	40 x 30	3.58	3.80	128	110	ALC40(1)222EB100
100	2700	DD	35 x 40	2.41	3.07	146	118	ALC40(1)272DD100
100	2700	ED	40 x 40	4.92	5.24	95	80	ALC40(1)272ED100
100	3300	DF	35 x 50	3.12	3.97	108	86	ALC40(1)332DF100
100	3300	EE	40 x 45	5.59	5.95	78	66	ALC40(1)332EE100
100	3900	EF	40 x 50	6.41	6.83	65	55	ALC40(1)392EF100
100	4700	EG	40 x 55	6.67	7.04	58	50	ALC40(1)472EG100
100	5600	EH	40 x 60	7.46	7.87	49	42	ALC40(1)562EH100
100	8200	EL	40 x 80	9.28	9.78	34	29	ALC40(1)822EL100
100	10000	EP	40 x 105	11.33	13.12	24	21	ALC40(1)103EP100
200	270	BB	25 x 30	1.01	1.56	542	377	ALC40(1)271BB200
200	390	BC	25 x 35	1.24	1.86	386	271	ALC40(1)391BC200
200	470	BD	25 x 40	1.45	2.19	320	224	ALC40(1)471BD200
200	470	CB	30 x 30	1.24	1.76	369	270	ALC40(1)471CB200
200	560	CC	30 x 35	1.50	2.13	301	219	ALC40(1)561CC200
200	680	CD	30 x 40	1.72	2.44	249	181	ALC40(1)681CD200
200	680	EB	40 x 30	2.97	3.67	202	158	ALC40(1)681EB200
200	820	CF	30 x 50	2.18	3.16	196	140	ALC40(1)821CF200
200	820	DC	35 x 35	1.70	2.34	252	191	ALC40(1)821DC200
200	820	EC	40 x 35	3.35	4.06	173	137	ALC40(1)821EC200
200	1000	DD	35 x 40	1.95	2.69	208	158	ALC40(1)102DD200
200	1000	ED	40 x 40	3.92	4.80	140	110	ALC40(1)102ED200
200	1200	DF	35 x 50	2.50	3.48	159	119	ALC40(1)122DF200
200	1200	EE	40 x 45	4.50	5.50	116	91	ALC40(1)122EE200
200	1500	EF	40 x 50	5.13	6.23	94	74	ALC40(1)152EF200
200	1800	EH	40 x 60	6.10	7.53	76	60	ALC40(1)182EH200
200	2700	EL	40 x 80	7.62	9.32	52	41	ALC40(1)272EL200
200	3900	EP	40 x 105	7.90	12.31	49	34	ALC40(1)392EP200
200	5600	FP	45 x 105	8.68	12.54	40	28	ALC40(1)562FP200
200	6800	KP	50 x 105	9.08	12.29	36	26	ALC40(1)682KP200
250	220	BB	25 x 30	0.93	1.50	592	405	ALC40(1)221BB250
250	270	BC	25 x 35	1.10	1.77	480	327	ALC40(1)271BC250
250	330	BD	25 x 40	1.29	2.08	393	268	ALC40(1)331BD250
250	330	CB	30 x 30	1.13	1.69	441	312	ALC40(1)331CB250
250	390	CC	30 x 35	1.36	2.04	364	256	ALC40(1)391CC250
250	470	CD	30 x 40	1.56	2.34	302	212	ALC40(1)471CD250
250	470	EB	40 x 30	2.59	3.49	258	193	ALC40(1)471EB250
250	560	CF	30 x 50	1.96	3.02	243	168	ALC40(1)561CF250
250	560	DC	35 x 35	1.57	2.25	297	217	ALC40(1)561DC250
250	560	EC	40 x 35	3.05	4.16	221	166	ALC40(1)561EC250
250	680	DD	35 x 40	1.80	2.59	245	179	ALC40(1)681DD250
250	680	ED	40 x 40	3.49	4.76	180	134	ALC40(1)681ED250
250	820	DF	35 x 50	3.12	4.66	190	137	ALC40(1)821DF250
250	820	EE	40 x 45	4.01	5.46	149	111	ALC40(1)821EE250
250	1000	DH	35 x 60	3.61	5.78	164	125	ALC40(1)102DH250
250	1000	EF	40 x 50	4.58	6.22	123	92	ALC40(1)102EF250
250	1200	EG	40 x 55	4.93	6.51	106	80	ALC40(1)122EG250
250	1500	DL	35 x 80	4.43	6.88	112	90	ALC40(1)152DL250
250	1800	EL	40 x 80	6.77	9.27	67	50	ALC40(1)182EL250
250	2700	EP	40 x 105	7.05	12.03	62	42	ALC40(1)272EP250
250	3900	FP	45 x 105	7.90	12.43	50	33	ALC40(1)392FP250
250	4700	KP	50 x 105	8.36	12.30	44	30	ALC40(1)472KP250
350	120	BB	25 x 30	0.88	2.07	868	562	ALC40(1)121BB350
350	150	BC	25 x 35	1.04	2.46	694	449	ALC40(1)151BC350
350	180	BD	25 x 40	1.20	2.81	578	374	ALC40(1)181BD350

(1) Termination code: See Termination Tables for available options.

Table 1 – Ratings & Part Number Reference cont.

VDC	Rated Capacitance	Size Code	Case Size	Ripple Current		ESR Maximum	Impedance Maximum	Part Number
	100 Hz 20°C (µF)		D x L (mm)	100 Hz 105°C (A)	10 kHz 105°C (A)	100 Hz 20°C (mΩ)	10 kHz 20°C (mΩ)	
350	180	CB	30 x 30	1.17	2.46	618	410	ALC40(1)181CB350
350	220	CC	30 x 35	1.36	2.88	502	332	ALC40(1)221CC350
350	270	CD	30 x 40	1.59	3.33	410	272	ALC40(1)271CD350
350	270	EB	40 x 30	1.97	4.36	448	291	ALC40(1)271EB350
350	330	DC	35 x 35	1.79	3.24	378	260	ALC40(1)331DC350
350	390	CF	30 x 50	2.02	4.02	287	191	ALC40(1)391CF350
350	390	DD	35 x 40	2.02	3.67	317	218	ALC40(1)391DD350
350	390	ED	40 x 40	2.64	5.73	312	203	ALC40(1)391ED350
350	470	DF	35 x 50	2.72	4.90	251	170	ALC40(1)471DF350
350	470	EE	40 x 45	3.00	6.46	258	168	ALC40(1)471EE350
350	560	DF	35 x 50	2.57	4.44	224	155	ALC40(1)561DF350
350	560	DH	35 x 60	3.11	5.70	224	155	ALC40(1)561DH350
350	560	EF	40 x 50	3.41	7.27	216	141	ALC40(1)561EF350
350	680	EH	40 x 60	3.99	8.39	177	114	ALC40(1)681EH350
350	820	DL	35 x 80	3.82	6.72	150	102	ALC40(1)821DL350
350	1000	EL	40 x 80	5.00	9.98	120	78	ALC40(1)102EL350
350	1500	EP	40 x 105	6.00	11.47	99	68	ALC40(1)152EP350
350	2200	FP	45 x 105	6.79	12.06	77	53	ALC40(1)222FP350
350	2700	KP	50 x 105	7.34	12.08	66	45	ALC40(1)272KP350
400	100	BB	25 x 30	0.85	2.09	1193	788	ALC40(1)101BB400
400	120	BC	25 x 35	1.00	2.45	991	653	ALC40(1)121BC400
400	150	BD	25 x 40	1.17	2.83	794	524	ALC40(1)151BD400
400	150	CB	30 x 30	1.14	2.46	835	562	ALC40(1)151CB400
400	180	CC	30 x 35	1.31	2.88	690	463	ALC40(1)181CC400
400	220	CD	30 x 40	1.54	3.33	565	379	ALC40(1)221CD400
400	220	EB	40 x 30	1.88	4.36	521	320	ALC40(1)221EB400
400	270	DC	35 x 35	1.73	3.23	470	322	ALC40(1)271DC400
400	270	EC	40 x 35	2.21	4.95	430	266	ALC40(1)271EC400
400	330	CF	30 x 50	1.98	4.02	383	258	ALC40(1)331CF400
400	330	DD	35 x 40	1.98	3.64	386	266	ALC40(1)331DD400
400	330	ED	40 x 40	2.56	5.76	350	216	ALC40(1)331ED400
400	390	DF	35 x 50	2.64	4.66	323	221	ALC40(1)391DF400
400	390	EE	40 x 45	2.88	6.48	295	182	ALC40(1)391EE400
400	470	DE	35 x 45	2.50	4.73	300	192	ALC40(1)471DE400
400	470	DF	35 x 50	2.51	4.40	277	192	ALC40(1)471DF400
400	470	DH	35 x 60	3.04	5.78	270	185	ALC40(1)471DH400
400	470	EF	40 x 50	3.28	7.30	245	151	ALC40(1)471EF400
400	560	EG	40 x 55	3.62	7.78	209	130	ALC40(1)561EG400
400	680	DL	35 x 80	3.72	6.69	200	131	ALC40(1)681DL400
400	680	EH	40 x 60	4.08	8.58	173	107	ALC40(1)681EH400
400	1000	EL	40 x 80	4.85	10.16	118	73	ALC40(1)102EL400
400	1200	EP	40 x 105	5.76	11.46	103	70	ALC40(1)122EP400
400	1800	FP	45 x 105	6.48	12.04	82	55	ALC40(1)182FP400
400	2200	KP	50 x 105	7.02	12.08	70	47	ALC40(1)222KP400
450	47	BB	25 x 30	0.66	1.74	2011	1392	ALC40(1)470BB450
450	56	BC	25 x 35	0.76	2.03	1687	1168	ALC40(1)560BC450
450	68	BD	25 x 40	0.88	2.34	1391	963	ALC40(1)680BD450
450	68	CB	30 x 30	0.87	2.19	1403	974	ALC40(1)680CB450
450	82	CC	30 x 35	1.01	2.54	1163	807	ALC40(1)820CC450
450	100	CD	30 x 40	1.18	2.95	955	663	ALC40(1)101CD450
450	120	DC	35 x 35	1.36	3.11	810	565	ALC40(1)121DC450
450	150	CF	30 x 50	1.54	3.67	642	446	ALC40(1)151CF450
450	150	DD	35 x 40	1.57	3.53	651	454	ALC40(1)151DD450
450	150	EB	40 x 30	1.73	4.14	642	447	ALC40(1)151EB450
450	180	DF	35 x 50	1.88	4.27	541	377	ALC40(1)181DF450
450	180	EC	40 x 35	2.01	4.70	538	374	ALC40(1)181EC450
450	220	DF	35 x 50	2.28	4.71	449	315	ALC40(1)221DF450
450	220	ED	40 x 40	2.34	5.47	440	306	ALC40(1)221ED450
450	270	EF	40 x 50	2.80	6.74	356	248	ALC40(1)271EF450
VDC	Rated Capacitance	Size Code	Case Size	Ripple Current		ESR	Impedance	Part Number

(1) Termination code: See Termination Tables for available options.

Table 1 – Ratings & Part Number Reference cont.

VDC	Rated Capacitance	Size Code	Case Size	Ripple Current		ESR Maximum	Impedance Maximum	Part Number
	100 Hz 20°C (µF)		D x L (mm)	100 Hz 105°C (A)	10 kHz 105°C (A)	100 Hz 20°C (mΩ)	10 kHz 20°C (mΩ)	
450	330	DF	35 x 50	2.53	5.14	206	140	ALC40(1)331DF450
450	330	DH	35 x 60	2.91	5.53	285	198	ALC40(1)331DH450
450	330	EG	40 x 55	3.14	7.29	293	204	ALC40(1)331EG450
450	390	EH	40 x 60	3.50	8.04	249	174	ALC40(1)391EH450
450	470	DH	35 X 60	3.00	5.82	232	148	ALC40(1)471DH450
450	470	DL	35 x 80	3.51	6.68	203	138	ALC40(1)471DL450
450	560	EL	40 x 80	4.32	9.57	175	122	ALC40(1)561EL450
450	820	EL	40 X 80	4.30	10.04	154	98	ALC40(1)821EL450
450	820	EP	40 x 105	5.34	11.05	121	85	ALC40(1)821EP450
450	1200	FP	45 x 105	5.84	11.64	105	71	ALC40(1)122FP450
450	1500	KP	50 x 105	6.44	11.85	86	59	ALC40(1)152KP450
500	56	BB	25 x 30	0.75	1.58	3930	3170	ALC40(1)560BB500
500	68	BC	25 x 35	0.85	1.81	3240	2610	ALC40(1)680BC500
500	82	BD	25 x 40	0.97	2.05	2690	2170	ALC40(1)820BD500
500	82	CB	30 x 30	1.00	2.03	2700	2180	ALC40(1)820CB500
500	120	CC	30 x 35	1.26	2.51	1850	1500	ALC40(1)121CC500
500	150	DC	35 x 35	1.51	2.88	1500	1210	ALC40(1)151DC500
500	180	CF	30 x 50	1.67	3.34	1230	1000	ALC40(1)181CF500
500	180	DD	35 x 40	1.71	3.26	1250	1010	ALC40(1)181DD500
500	180	EB	40 x 30	1.77	3.55	1250	1010	ALC40(1)181EB500
500	220	EC	40 x 35	2.03	4.09	1020	820	ALC40(1)221EC500
500	270	DF	35 x 50	2.20	4.06	840	680	ALC40(1)271DF500
500	270	ED	40 x 40	2.32	4.66	830	670	ALC40(1)271ED500
500	330	DH	35 x 60	2.52	4.62	690	560	ALC40(1)331DH500
500	390	EF	40 x 50	2.94	5.81	580	470	ALC40(1)391EF500
500	470	DL	35 x 80	3.14	5.61	480	390	ALC40(1)471DL500
500	470	EG	40 x 55	3.30	6.42	480	390	ALC40(1)471EG500
500	680	EL	40 x 80	4.25	8.14	330	270	ALC40(1)681EL500
500	820	EP	40 x 105	4.71	8.95	280	220	ALC40(1)821EP500
500	1000	FP	45 x 105	5.52	10.08	230	190	ALC40(1)102FP500
500	1200	KP	50 x 105	6.27	11.00	190	160	ALC40(1)122KP500
VDC	Rated Capacitance	Size Code	Case Size	Ripple Current		ESR	Impedance	Part Number

(1) Termination code: See Termination Tables for available options.

Mechanical Data

Polarity and Reversed Voltage

Aluminium Electrolytic capacitors manufactured for use in DC applications contain an anode foil and a cathode foil. As such, they are polarized devices and must be connected with the +ve to the anode foil and the -ve to the cathode foil. If this were to be reversed then the electrolytic process that took place in forming the oxide layer on the anode would be recreated in trying to form an oxide layer on the cathode. In forming the cathode foil in this way, heat would be generated and gas given off within the capacitor, usually leading to catastrophic failure.

The cathode foil already possesses a thin stabilized oxide layer. This thin oxide layer is equivalent to a forming voltage of approximately 2 V. As a result, the capacitor can withstand a voltage reversal of up to 2 V for short periods. Above this voltage, the formation process will commence. Aluminium Electrolytic capacitors can also be manufactured for use in intermittent AC applications by using two anode foils in place of one anode and one cathode.

Mounting Position

The capacitor can be mounted upright or inclined to a horizontal position.

Insulating Resistance

≥ 100 MΩ at 100 VDC across insulating sleeve. UL recognized sleeving is available for custom parts in this range, upon request.

(UL No. E358957)

Voltage Proof

≥ 2,500 VDC across insulating sleeve.

Safety Vent

A safety vent for overpressure is featured on either the base (opposing end to the terminals) or the side of the can. This appears in the form of a grooved section on the surface of the can, which is a weakened area and designed to relieve build-up of internal pressure due to overstress or catastrophic failure.

Marking

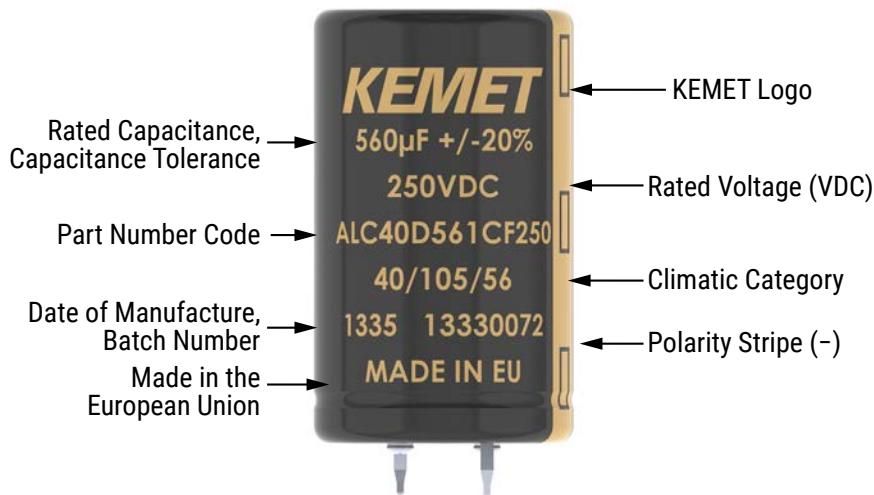

Construction

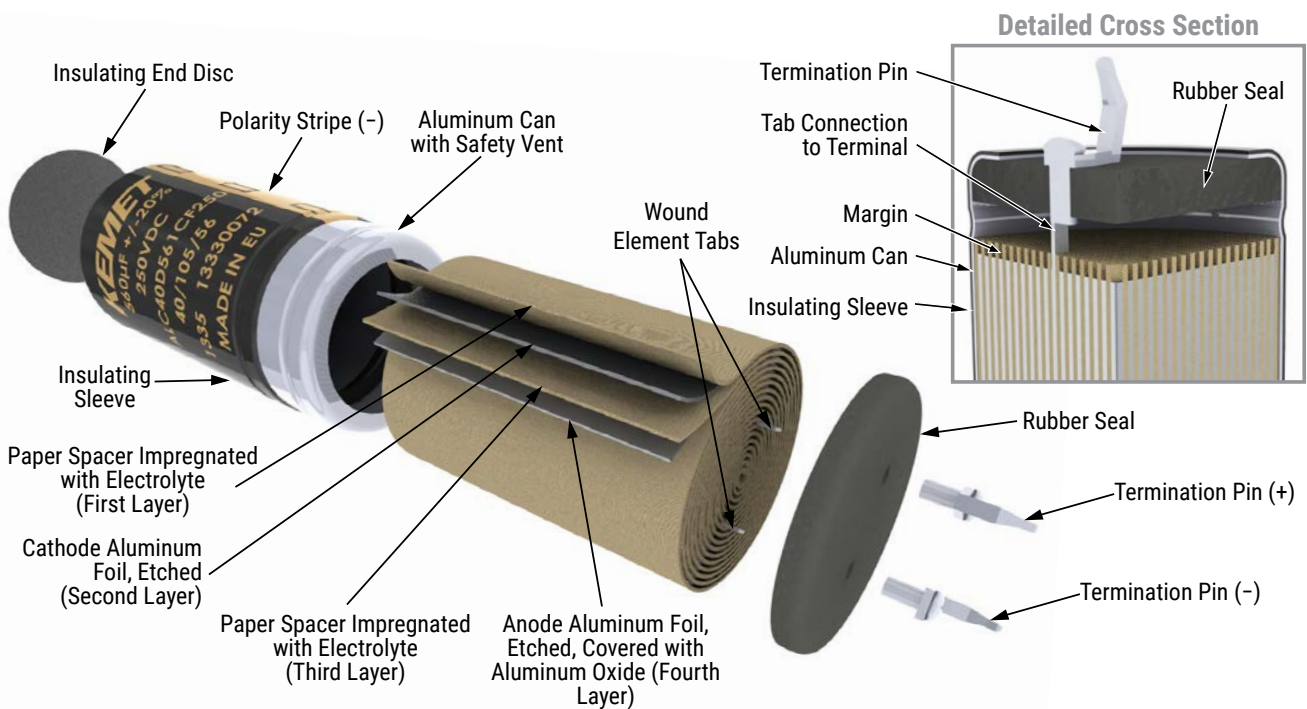

Construction Data

The manufacturing process begins with the anode foil being electrochemically etched to increase the surface area and then “formed” to produce the aluminum oxide layer. Both the anode and cathode foils are then interleaved with absorbent paper and wound into a cylinder. During the winding process, aluminum tabs are attached to each foil to provide the electrical contact.

The deck, complete with terminals, is attached to the tabs and then folded down to rest on top of the winding. The complete winding is impregnated with electrolyte before being housed in a suitable container, usually an aluminum can, and sealed. Throughout the process, all materials inside the housing must be maintained at the highest purity and be compatible with the electrolyte.

Each capacitor is aged and tested before being sleeved and packed. The purpose of aging is to repair any damage in the oxide layer and thus reduce the leakage current to a very low level. Aging is normally carried out at the rated temperature of the capacitor and is accomplished by applying voltage to the device while carefully controlling the supply current. The process may take several hours to complete.

Damage to the oxide layer can occur due to variety of reasons:

- Slitting of the anode foil after forming
- Attaching the tabs to the anode foil
- Minor mechanical damage caused during winding

A sample from each batch is taken by the quality department after completion of the production process. This sample size is controlled by the use of recognized sampling tables defined in BS 6001.

The following tests are applied and may be varied at the request of the customer. In this case the batch, or special procedure, will determine the course of action.

Electrical:

- Leakage current
- Capacitance
- ESR
- Impedance
- Tan Delta

Mechanical/Visual:

- Overall dimensions
- Torque test of mounting stud
- Print detail
- Box labels
- Packaging, including packed quantity



KEMET Electronics Corporation Sales Offices

For a complete list of our global sales offices, please visit www.kemet.com/sales.

Disclaimer

All product specifications, statements, information and data (collectively, the "Information") in this datasheet are subject to change. The customer is responsible for checking and verifying the extent to which the Information contained in this publication is applicable to an order at the time the order is placed. All Information given herein is believed to be accurate and reliable, but it is presented without guarantee, warranty, or responsibility of any kind, expressed or implied.

Statements of suitability for certain applications are based on KEMET Electronics Corporation's ("KEMET") knowledge of typical operating conditions for such applications, but are not intended to constitute – and KEMET specifically disclaims – any warranty concerning suitability for a specific customer application or use. The Information is intended for use only by customers who have the requisite experience and capability to determine the correct products for their application. Any technical advice inferred from this Information or otherwise provided by KEMET with reference to the use of KEMET's products is given gratis, and KEMET assumes no obligation or liability for the advice given or results obtained.

Although KEMET designs and manufactures its products to the most stringent quality and safety standards, given the current state of the art, isolated component failures may still occur. Accordingly, customer applications which require a high degree of reliability or safety should employ suitable designs or other safeguards (such as installation of protective circuitry or redundancies) in order to ensure that the failure of an electrical component does not result in a risk of personal injury or property damage.

Although all product-related warnings, cautions and notes must be observed, the customer should not assume that all safety measures are indicated or that other measures may not be required.

KEMET is a registered trademark of KEMET Electronics Corporation.