

ELM89xxxBC CMOS 300mA LDO Voltage regulator

■ General description

ELM89xxxBC is CMOS LDO voltage regulator. There are 3 types of CE selection for ELM89 series: non-chip enable function, “L”active and “H”active. Thermal shutdown protective function and short circuit current limiter are included in the IC. The standard output voltages are 1.2V, 1.8V, 2.5V, 3.0V, 3.3V, 5.0V; ELM89 series can also be designed as semi-custom IC within the range of 0.8V to 5.0V by 0.1V step.

■ Features

- Output voltage range : 0.8V to 5.0V (by 0.1V)
- Output current : 300mA
- Stand by current consumption : Typ.0.1μA
- Input stability : Typ.0.02%/V(Iout=40mA)
- Load stability : Typ.5mV(1mA≤Iout≤100mA)
- Accuracy of output voltage : ±2.0%(Vout>1.5V)
±30mV(Vout≤1.5V)
- Input-output voltage difference : Typ.350mV(Vout=3.0V, Iout=300mA)
- Short circuit current limiter : Typ.40mA(Vout=0V)
- Thermal shutdown protection : Typ.165°C
- Chip enable pin : “L”active(ELM89xx2BC)
“H”active(ELM89xx3BC)
- Package : SOT-23, SOT-25

■ Application

- Battery operated devices
- Wireless devices
- Cell phones
- Battery-operated devices
- PCs

■ Maximum absolute ratings

Parameter	Symbol	Limit	Unit
Input voltage	Vin	Vss-0.3 to 7.0	V
CE/CE Input voltage	Vce	Vss-0.3 to Vin+0.3	V
Output voltage	Vout	Vss-0.3 to Vin+0.3	V
Output current	Iout	600	mA
Power dissipation	Pd	250 (SOT-23)	mW
		250 (SOT-25)	
Operating Temperature	Top	-40 to +85	°C
Storage Temperature	Tstg	-55 to +125	°C

■ Selection guide

ELM89xxxBC-x

Symbol		
a, b	Output voltage	e.g. : 12: Vout=1.2V 18: Vout=1.8V 25: Vout=2.5V 30: Vout=3.0V 33: Vout=3.3V 50: Vout=5.0V
c	CE selection	1: No CE 2: CE=“L”active 3: CE=“H”active
d	Package	B: SOT-23, SOT-25
e	Product version	C
f	Taping direction	S, N: Refer to PKG file

ELM89 x x x B C - x
 ↑ ↑ ↑ ↑ ↑ ↑
 a b c d e f

ELM89xxxBC CMOS 300mA LDO Voltage regulator

■ Pin configuration

SOT-23(TOP VIEW)

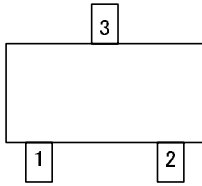

ELM89xx1BC

Pin No.	Pin name
1	VIN
2	VOUT
3	VSS

SOT-25(TOP VIEW)

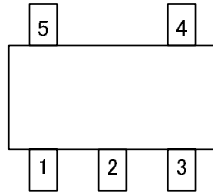

ELM89xx2BC

Pin No.	Pin name
1	VIN
2	VSS
3	$\overline{\text{CE}}$
4	NC
5	VOUT

SOT-25(TOP VIEW)

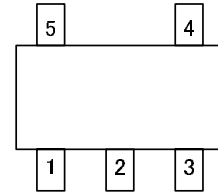

ELM89xx3BC

Pin No.	Pin name
1	VIN
2	VSS
3	CE
4	NC
5	VOUT

■ Standard circuit

ELM89xx1BC

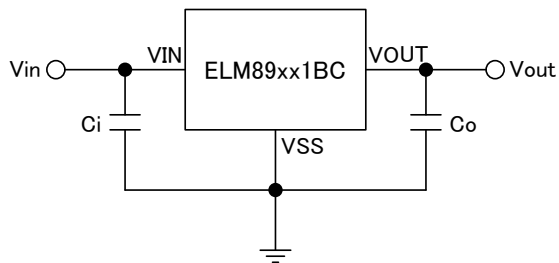

* $C_i=1\mu\text{F}$, $C_o=1\mu\text{F}$ or greater

ELM89xx2BC: $\overline{\text{CE}}$, ELM89xx3BC: CE

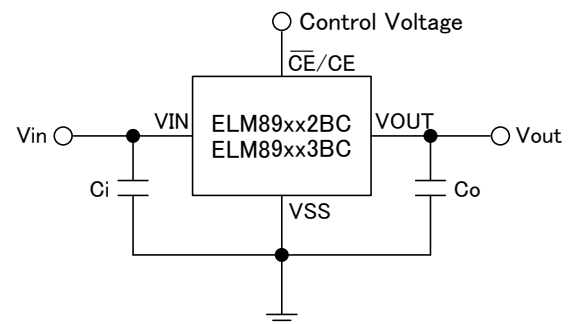

* $C_i=1\mu\text{F}$, $C_o=1\mu\text{F}$ or greater

■ Block diagram

ELM89xx1BC

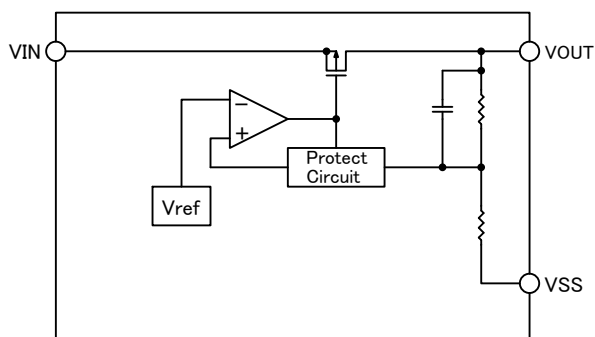

ELM89xx2BC: $\overline{\text{CE}}$, ELM89xx3BC: CE

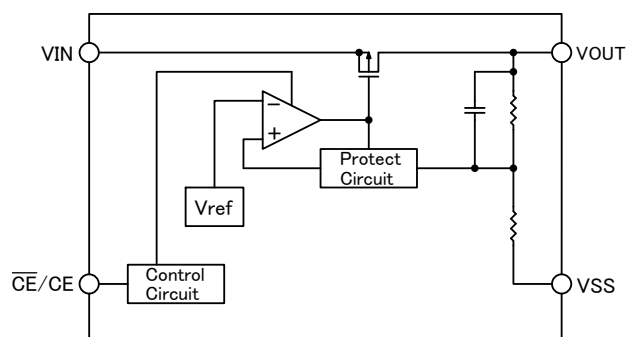

ELM89xxxBC CMOS 300mA LDO Voltage regulator

■Electrical characteristics (ELM89xx1BC)

Vout=1.2V(ELM89121BC), No CE pin

Top=25°C

Parameter	Symbol	Condition	Min.	Typ.	Max.	Unit
Output voltage	Vout	Vin=2.2V, Iout=40mA	1.170	1.200	1.230	V
Output current	Iout	Vin=2.2V	300			mA
Input stability	$\Delta V_{out}/\Delta V_{in}$	Iout=40mA, 1.7V≤Vin≤6.0V		0.05	0.20	%/V
Load stability	$\Delta V_{out}/\Delta I_{out}$	1mA≤Iout≤100mA, Vin=2.2V		5	20	mV
Input-Output voltage differential	Vdif	Iout=100mA		380	620	mV
Current consumption	Iss	Vin=2.2V, No-load		15	50	μA
Input voltage	Vin		1.4		6.0	V
Output voltage temperature coefficient	$\Delta V_{out}/\Delta T_{op}$	-40°C≤Top≤+85°C, Iout=40mA, Vin=2.2V		±100		ppm/°C
Short circuit current	Ilim	Vout=0V		40		mA
Ripple rejection ratio	RR	f=1kHz, Iout=40mA		60		dB
Thermal shutdown temperature	Tsd			165		°C
Output noise	Vno	BW=10Hz to 100kHz		30		μVrms

Vout=1.8V(ELM89181BC), No CE pin

Top=25°C

Parameter	Symbol	Condition	Min.	Typ.	Max.	Unit
Output voltage	Vout	Vin=2.8V, Iout=40mA	1.764	1.800	1.836	V
Output current	Iout	Vin=2.8V	300			mA
Input stability	$\Delta V_{out}/\Delta V_{in}$	Iout=40mA, 2.3V≤Vin≤6.0V		0.02	0.20	%/V
Load stability	$\Delta V_{out}/\Delta I_{out}$	1mA≤Iout≤100mA, Vin=2.8V		5	20	mV
Input-Output voltage differential	Vdif	Iout=100mA		145	230	mV
Current consumption	Iss	Vin=2.8V, No-load		15	50	μA
Input voltage	Vin		1.4		6.0	V
Output voltage temperature coefficient	$\Delta V_{out}/\Delta T_{op}$	-40°C≤Top≤+85°C, Iout=40mA, Vin=2.8V		±100		ppm/°C
Short circuit current	Ilim	Vout=0V		40		mA
Ripple rejection ratio	RR	f=1kHz, Iout=40mA		60		dB
Thermal shutdown temperature	Tsd			165		°C
Output noise	Vno	BW=10Hz to 100kHz		30		μVrms

Vout=2.5V(ELM89251BC), No CE pin

Top=25°C

Parameter	Symbol	Condition	Min.	Typ.	Max.	Unit
Output voltage	Vout	Vin=3.5V, Iout=40mA	2.450	2.500	2.550	V
Output current	Iout	Vin=3.5V	300			mA
Input stability	$\Delta V_{out}/\Delta V_{in}$	Iout=40mA, 3.0V≤Vin≤6.0V		0.02	0.20	%/V
Load stability	$\Delta V_{out}/\Delta I_{out}$	1mA≤Iout≤100mA, Vin=3.5V		5	20	mV
Input-Output voltage differential	Vdif	Iout=100mA		120	190	mV
Current consumption	Iss	Vin=3.5V, No-load		15	50	μA
Input voltage	Vin		1.4		6.0	V
Output voltage temperature coefficient	$\Delta V_{out}/\Delta T_{op}$	-40°C≤Top≤+85°C, Iout=40mA, Vin=3.5V		±100		ppm/°C
Short circuit current	Ilim	Vout=0V		40		mA
Ripple rejection ratio	RR	f=1kHz, Iout=40mA		60		dB
Thermal shutdown temperature	Tsd			165		°C
Output noise	Vno	BW=10Hz to 100kHz		30		μVrms

ELM89xxxBC CMOS 300mA LDO Voltage regulator

Vout=3.0V(ELM89301BC), No CE pin

Top=25°C

Parameter	Symbol	Condition	Min.	Typ.	Max.	Unit
Output voltage	Vout	Vin=4.0V, Iout=40mA	2.940	3.000	3.060	V
Output current	Iout	Vin=4.0V	300			mA
Input stability	$\Delta V_{out}/\Delta V_{in}$	Iout=40mA, 3.5V≤Vin≤6.0V		0.02	0.20	%/V
Load stability	$\Delta V_{out}/\Delta I_{out}$	1mA≤Iout≤100mA, Vin=4.0V		5	20	mV
Input-Output voltage differential	Vdif	Iout=100mA		110	175	mV
Current consumption	I _{ss}	Vin=4.0V, No-load		15	50	μA
Input voltage	Vin		1.4		6.0	V
Output voltage temperature coefficient	$\Delta V_{out}/\Delta T_{op}$	-40°C≤Top≤+85°C, Iout=40mA, Vin=4.0V		±100		ppm/°C
Short circuit current	I _{lim}	Vout=0V		40		mA
Ripple rejection ratio	RR	f=1kHz, Iout=40mA		60		dB
Thermal shutdown temperature	Tsd			165		°C
Output noise	Vno	BW=10Hz to 100kHz		30		μVrms

Vout=3.3V(ELM89331BC), No CE pin

Top=25°C

Parameter	Symbol	Condition	Min.	Typ.	Max.	Unit
Output voltage	Vout	Vin=4.3V, Iout=40mA	3.234	3.300	3.366	V
Output current	Iout	Vin=4.3V	300			mA
Input stability	$\Delta V_{out}/\Delta V_{in}$	Iout=40mA, 3.8V≤Vin≤6.0V		0.02	0.20	%/V
Load stability	$\Delta V_{out}/\Delta I_{out}$	1mA≤Iout≤100mA, Vin=4.3V		5	20	mV
Input-Output voltage differential	Vdif	Iout=100mA		110	175	mV
Current consumption	I _{ss}	Vin=4.3V, No-load		15	50	μA
Input voltage	Vin		1.4		6.0	V
Output voltage temperature coefficient	$\Delta V_{out}/\Delta T_{op}$	-40°C≤Top≤+85°C, Iout=40mA, Vin=4.3V		±100		ppm/°C
Short circuit current	I _{lim}	Vout=0V		40		mA
Ripple rejection ratio	RR	f=1kHz, Iout=40mA		60		dB
Thermal shutdown temperature	Tsd			165		°C
Output noise	Vno	BW=10Hz to 100kHz		30		μVrms

Vout=5.0V(ELM89501BC), No CE pin

Top=25°C

Parameter	Symbol	Condition	Min.	Typ.	Max.	Unit
Output voltage	Vout	Vin=6.0V, Iout=40mA	4.900	5.000	5.100	V
Output current	Iout	Vin=6.0V	300			mA
Input stability	$\Delta V_{out}/\Delta V_{in}$	Iout=40mA, 5.5V≤Vin≤6.0V		0.02	0.20	%/V
Load stability	$\Delta V_{out}/\Delta I_{out}$	1mA≤Iout≤100mA, Vin=6.0V		5	20	mV
Input-Output voltage differential	Vdif	Iout=100mA		100	160	mV
Current consumption	I _{ss}	Vin=6.0V, No-load		15	50	μA
Input voltage	Vin		1.4		6.0	V
Output voltage temperature coefficient	$\Delta V_{out}/\Delta T_{op}$	-40°C≤Top≤+85°C, Iout=40mA, Vin=6.0V		±100		ppm/°C
Short circuit current	I _{lim}	Vout=0V		40		mA
Ripple rejection ratio	RR	f=1kHz, Iout=40mA		60		dB
Thermal shutdown temperature	Tsd			165		°C
Output noise	Vno	BW=10Hz to 100kHz		30		μVrms

ELM89xxxBC CMOS 300mA LDO Voltage regulator

■Electrical characteristics (ELM89xx2BC)

Vout=1.8V(ELM89182BC), \overline{CE} ="L" active

Top=25°C

Parameter	Symbol	Condition	Min.	Typ.	Max.	Unit
Output voltage	Vout	Vin=2.8V, Iout=40mA	1.764	1.800	1.836	V
Output current	Iout	Vin=2.8V	300			mA
Input stability	$\Delta V_{out}/\Delta V_{in}$	Iout=40mA, 2.3V≤Vin≤6.0V		0.02	0.20	%/V
Load stability	$\Delta V_{out}/\Delta I_{out}$	1mA≤Iout≤100mA, Vin=2.8V		5	20	mV
Input-Output voltage differential	Vdif	Iout=100mA		145	230	mV
Current consumption	I _{ss}	Vin=2.8V, No-load		15	50	μA
Stand-by current consumption	I _{standby}	Vin=Vce=2.8V			0.5	μA
Input voltage	Vin		1.4		6.0	V
\overline{CE} input voltage High	Vceh	Vin=6.0V	1.8		Vin	V
\overline{CE} input voltage Low	Vcel	Vin=1.4V	0.0		0.2	V
\overline{CE} input current High	Iceh	Vce=Vin=6.0V	-0.2	0.0	0.2	μA
\overline{CE} input current Low	Icel	Vce=Vss, Vin=6.0V	-0.2	0.0	0.2	
Output voltage temperature coefficient	$\Delta V_{out}/\Delta T_{op}$	-40°C≤Top≤+85°C, Iout=40mA, Vin=2.8V		±100		ppm/°C
Short circuit current	I _{lim}	Vout=0V		40		mA
Ripple rejection ratio	RR	f=1kHz, Iout=40mA		60		dB
Thermal shutdown temperature	Tsd			165		°C
Output noise	Vno	BW=10Hz to 100kHz		30		μVrms

■Electrical characteristics (ELM89xx3BC)

Vout=1.2V(ELM89123BC), CE="H" active

Top=25°C

Parameter	Symbol	Condition	Min.	Typ.	Max.	Unit
Output voltage	Vout	Vin=2.2V, Iout=40mA	1.170	1.200	1.230	V
Output current	Iout	Vin=2.2V	300			mA
Input stability	$\Delta V_{out}/\Delta V_{in}$	Iout=40mA, 1.7V≤Vin≤6.0V		0.05	0.20	%/V
Load stability	$\Delta V_{out}/\Delta I_{out}$	1mA≤Iout≤100mA, Vin=2.2V		5	20	mV
Input-Output voltage differential	Vdif	Iout=100mA		380	620	mV
Current consumption	I _{ss}	Vin=2.2V, No-load		15	50	μA
Stand-by current consumption	I _{standby}	Vin=2.2V, Vce=0			0.5	μA
Input voltage	Vin		1.4		6.0	V
CE input voltage High	Vceh	Vin=6.0V	1.8		Vin	V
CE input voltage Low	Vcel	Vin=1.4V	0.0		0.2	V
CE input current High	Iceh	Vce=Vin=6.0V	-0.2	0.0	0.2	μA
CE input current Low	Icel	Vce=Vss, Vin=6.0V	-0.2	0.0	0.2	
Output voltage temperature coefficient	$\Delta V_{out}/\Delta T_{op}$	-40°C≤Top≤+85°C, Iout=40mA, Vin=2.2V		±100		ppm/°C
Short circuit current	I _{lim}	Vout=0V		40		mA
Ripple rejection ratio	RR	f=1kHz, Iout=40mA		60		dB
Thermal shutdown temperature	Tsd			165		°C
Output noise	Vno	BW=10Hz to 100kHz		30		μVrms

ELM89xxxBC CMOS 300mA LDO Voltage regulator

Vout=1.8V(ELM89183BC), CE="H" active

Top=25°C

Parameter	Symbol	Condition	Min.	Typ.	Max.	Unit
Output voltage	Vout	Vin=2.8V, Iout=40mA	1.764	1.800	1.836	V
Output current	Iout	Vin=2.8V	300			mA
Input stability	$\Delta V_{out}/\Delta V_{in}$	Iout=40mA, 2.3V≤Vin≤6.0V		0.02	0.20	%/V
Load stability	$\Delta V_{out}/\Delta I_{out}$	1mA≤Iout≤100mA, Vin=2.8V		5	20	mV
Input-Output voltage differential	Vdif	Iout=100mA		145	230	mV
Current consumption	Iss	Vin=2.8V, No-load		15	50	μA
Stand-by current consumption	Istandby	Vin=2.8V, Vce=0			0.5	μA
Input voltage	Vin		1.4		6.0	V
CE input voltage High	Vceh	Vin=6.0V	1.8		Vin	V
CE input voltage Low	Vcel	Vin=1.4V	0.0		0.2	V
CE input current High	Iceh	Vce=Vin=6.0V	-0.2	0.0	0.2	μA
CE input current Low	Icel	Vce=Vss, Vin=6.0V	-0.2	0.0	0.2	
Output voltage temperature coefficient	$\Delta V_{out}/\Delta T_{op}$	-40°C≤Top≤+85°C, Iout=40mA, Vin=2.8V		±100		ppm/°C
Short circuit current	Ilim	Vout=0V		40		mA
Ripple rejection ratio	RR	f=1kHz, Iout=40mA		60		dB
Thermal shutdown temperature	Tsd			165		°C
Output noise	Vno	BW=10Hz to 100kHz		30		μVrms

Vout=2.5V(ELM89253BC), CE="H" active

Top=25°C

Parameter	Symbol	Condition	Min.	Typ.	Max.	Unit
Output voltage	Vout	Vin=3.5V, Iout=40mA	2.450	2.500	2.550	V
Output current	Iout	Vin=3.5V	300			mA
Input stability	$\Delta V_{out}/\Delta V_{in}$	Iout=40mA, 3.0V≤Vin≤6.0V		0.02	0.20	%/V
Load stability	$\Delta V_{out}/\Delta I_{out}$	1mA≤Iout≤100mA, Vin=3.5V		5	20	mV
Input-Output voltage differential	Vdif	Iout=100mA		120	190	mV
Current consumption	Iss	Vin=3.5V, No-load		15	50	μA
Stand-by current consumption	Istandby	Vin=3.5V, Vce=0			0.5	μA
Input voltage	Vin		1.4		6.0	V
CE input voltage High	Vceh	Vin=6.0V	1.8		Vin	V
CE input voltage Low	Vcel	Vin=1.4V	0.0		0.2	V
CE input current High	Iceh	Vce=Vin=6.0V	-0.2	0.0	0.2	μA
CE input current Low	Icel	Vce=Vss, Vin=6.0V	-0.2	0.0	0.2	
Output voltage temperature coefficient	$\Delta V_{out}/\Delta T_{op}$	-40°C≤Top≤+85°C, Iout=40mA, Vin=3.5V		±100		ppm/°C
Short circuit current	Ilim	Vout=0V		40		mA
Ripple rejection ratio	RR	f=1kHz, Iout=40mA		60		dB
Thermal shutdown temperature	Tsd			165		°C
Output noise	Vno	BW=10Hz to 100kHz		30		μVrms

ELM89xxxBC CMOS 300mA LDO Voltage regulator

Vout=3.0V(ELM89303BC), CE="H" active

Top=25°C

Parameter	Symbol	Condition	Min.	Typ.	Max.	Unit
Output voltage	Vout	Vin=4.0V, Iout=40mA	2.940	3.000	3.060	V
Output current	Iout	Vin=4.0V	300			mA
Input stability	$\Delta V_{out}/\Delta V_{in}$	Iout=40mA, 3.5V≤Vin≤6.0V		0.02	0.20	%/V
Load stability	$\Delta V_{out}/\Delta I_{out}$	1mA≤Iout≤100mA, Vin=4.0V		5	20	mV
Input-Output voltage differential	Vdif	Iout=100mA		110	175	mV
Current consumption	Iss	Vin=4.0V, No-load		15	50	μA
Stand-by current consumption	Istandby	Vin=4.0V, Vce=0			0.5	μA
Input voltage	Vin		1.4		6.0	V
CE input voltage High	Vceh	Vin=6.0V	1.8		Vin	V
CE input voltage Low	Vcel	Vin=1.4V	0.0		0.2	V
CE input current High	Iceh	Vce=Vin=6.0V	-0.2	0.0	0.2	μA
CE input current Low	Icel	Vce=Vss, Vin=6.0V	-0.2	0.0	0.2	
Output voltage temperature coefficient	$\Delta V_{out}/\Delta T_{op}$	-40°C≤Top≤+85°C, Iout=40mA, Vin=4.0V		±100		ppm/°C
Short circuit current	Ilim	Vout=0V		40		mA
Ripple rejection ratio	RR	f=1kHz, Iout=40mA		60		dB
Thermal shutdown temperature	Tsd			165		°C
Output noise	Vno	BW=10Hz to 100kHz		30		μVrms

Vout=3.3V(ELM89333BC), CE="H" active

Top=25°C

Parameter	Symbol	Condition	Min.	Typ.	Max.	Unit
Output voltage	Vout	Vin=4.3V, Iout=40mA	3.234	3.300	3.366	V
Output current	Iout	Vin=4.3V	300			mA
Input stability	$\Delta V_{out}/\Delta V_{in}$	Iout=40mA, 3.8V≤Vin≤6.0V		0.02	0.20	%/V
Load stability	$\Delta V_{out}/\Delta I_{out}$	1mA≤Iout≤100mA, Vin=4.3V		5	20	mV
Input-Output voltage differential	Vdif	Iout=100mA		110	175	mV
Current consumption	Iss	Vin=4.3V, No-load		15	50	μA
Stand-by current consumption	Istandby	Vin=4.3V, Vce=0			0.5	μA
Input voltage	Vin		1.4		6.0	V
CE input voltage High	Vceh	Vin=6.0V	1.8		Vin	V
CE input voltage Low	Vcel	Vin=1.4V	0.0		0.2	V
CE input current High	Iceh	Vce=Vin=6.0V	-0.2	0.0	0.2	μA
CE input current Low	Icel	Vce=Vss, Vin=6.0V	-0.2	0.0	0.2	
Output voltage temperature coefficient	$\Delta V_{out}/\Delta T_{op}$	-40°C≤Top≤+85°C, Iout=40mA, Vin=4.3V		±100		ppm/°C
Short circuit current	Ilim	Vout=0V		40		mA
Ripple rejection ratio	RR	f=1kHz, Iout=40mA		60		dB
Thermal shutdown temperature	Tsd			165		°C
Output noise	Vno	BW=10Hz to 100kHz		30		μVrms

ELM89xxxBC CMOS 300mA LDO Voltage regulator

Vout=5.0V(ELM89503BC), CE="H" active

Top=25°C

Parameter	Symbol	Condition	Min.	Typ.	Max.	Unit
Output voltage	Vout	Vin=6.0V, Iout=40mA	4.900	5.000	5.100	V
Output current	Iout	Vin=6.0V	300			mA
Input stability	$\Delta V_{out}/\Delta V_{in}$	Iout=40mA, 5.5V≤Vin≤6.0V		0.02	0.20	%/V
Load stability	$\Delta V_{out}/\Delta I_{out}$	1mA≤Iout≤100mA, Vin=6.0V		5	20	mV
Input-Output voltage differential	Vdif	Iout=100mA		100	160	mV
Current consumption	Iss	Vin=6.0V, No-load		15	50	μA
Stand-by current consumption	Istandby	Vin=6.0V, Vce=0			0.5	μA
Input voltage	Vin		1.4		6.0	V
CE input voltage High	Vceh	Vin=6.0V	1.8		Vin	V
CE input voltage Low	Vcel	Vin=1.4V	0.0		0.2	V
CE input current High	Iceh	Vce=Vin=6.0V	-0.2	0.0	0.2	μA
CE input current Low	Icel	Vce=Vss, Vin=6.0V	-0.2	0.0	0.2	
Output voltage temperature coefficient	$\Delta V_{out}/\Delta T_{op}$	-40°C≤Top≤+85°C, Iout=40mA, Vin=6.0V		±100		ppm/°C
Short circuit current	Ilim	Vout=0V		40		mA
Ripple rejection ratio	RR	f=1kHz, Iout=40mA		60		dB
Thermal shutdown temperature	Tsd			165		°C
Output noise	Vno	BW=10Hz to 100kHz		30		μVrms

■ Marking

- SOT-23 package : ELM89xx1BC
- SOT-25 package : ELM89xx2BC(with CE), ELM89xx3BC(with CE)

SOT-23

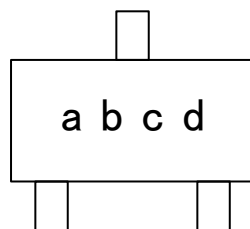

SOT-25

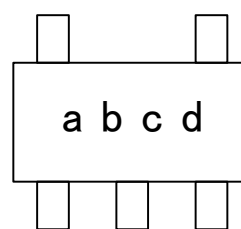

a to d : Assembly lot No. —
A to Z (I, O, X excepted) and 0 to 9

ELM89xxxBC CMOS 300mA LDO Voltage regulator

■ Typical characteristics

- 1.2V Vout unit (ELM8912xBC)

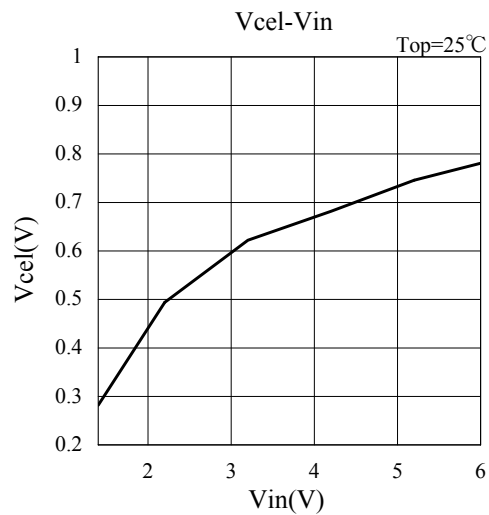
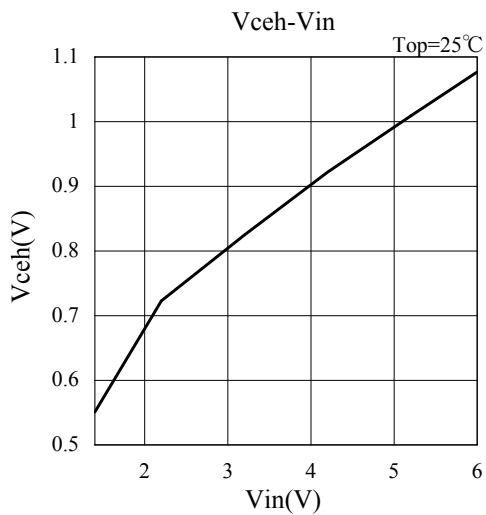
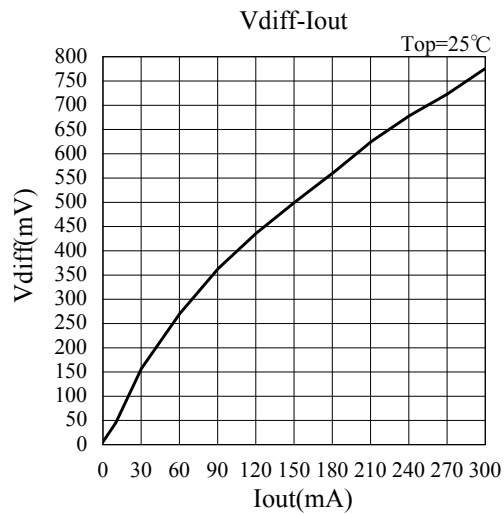
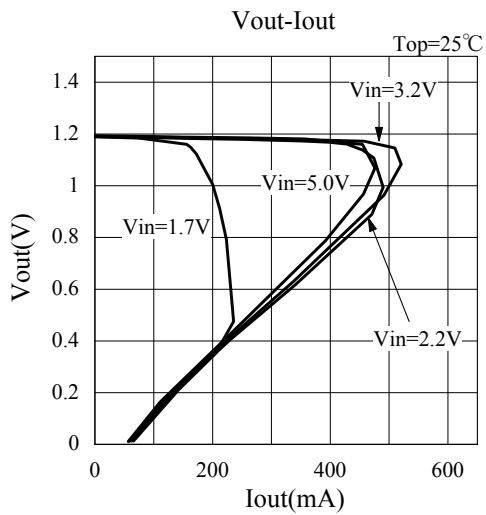
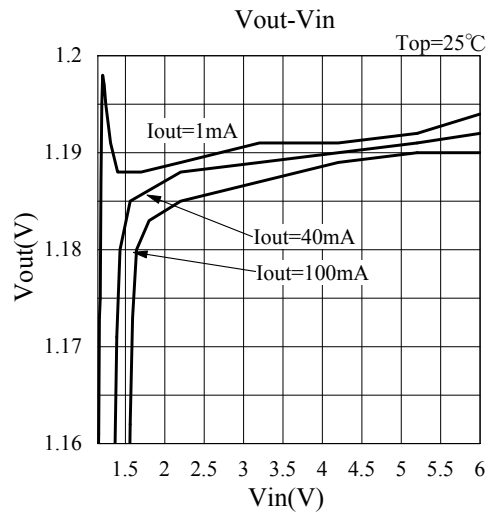
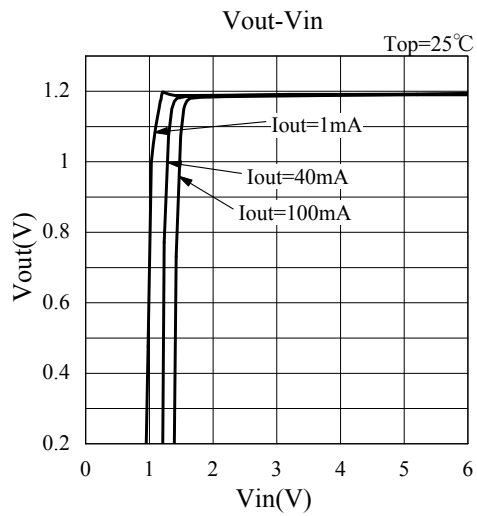

ELM89xxxBC CMOS 300mA LDO Voltage regulator

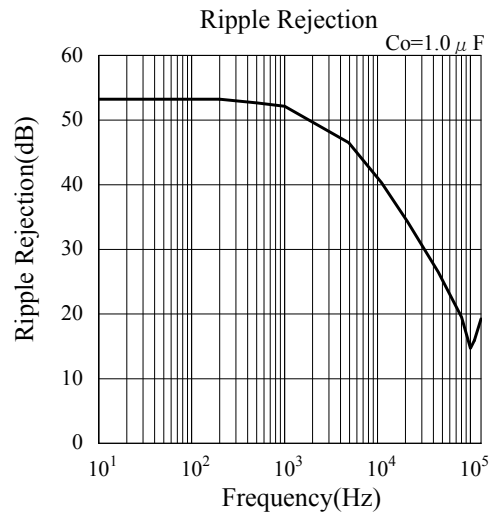
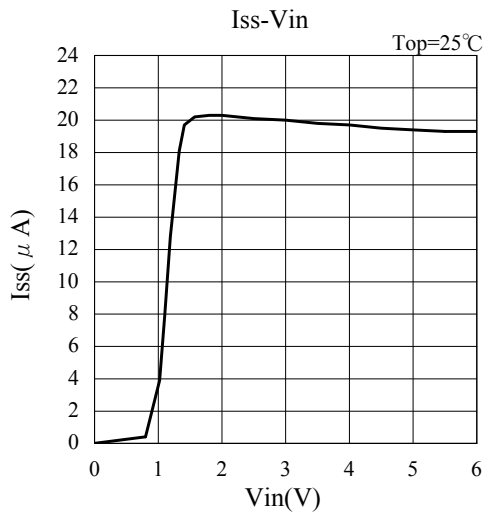
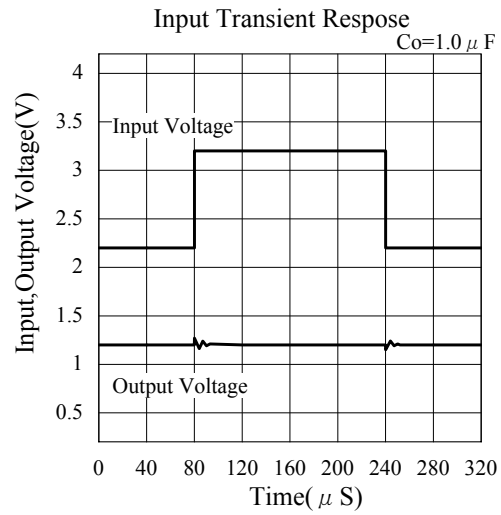
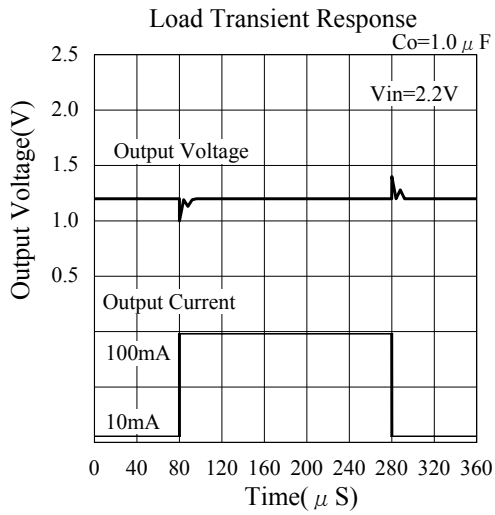

ELM89xxxBC CMOS 300mA LDO Voltage regulator

- 1.8V Vout unit (ELM8918xBC)

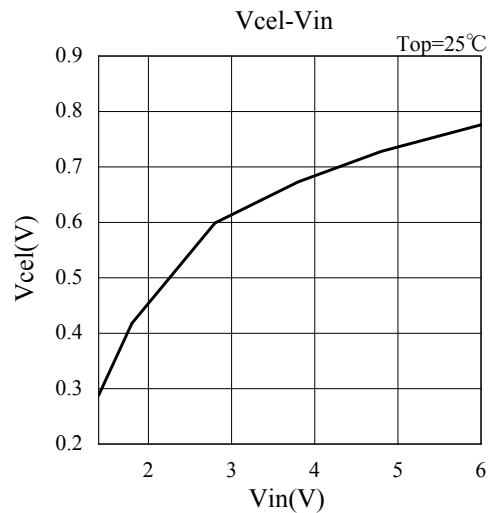
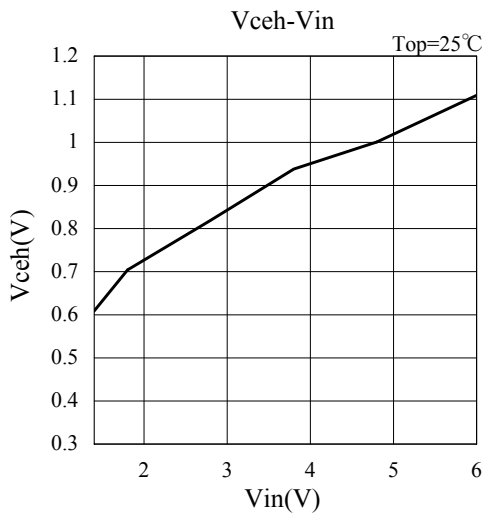
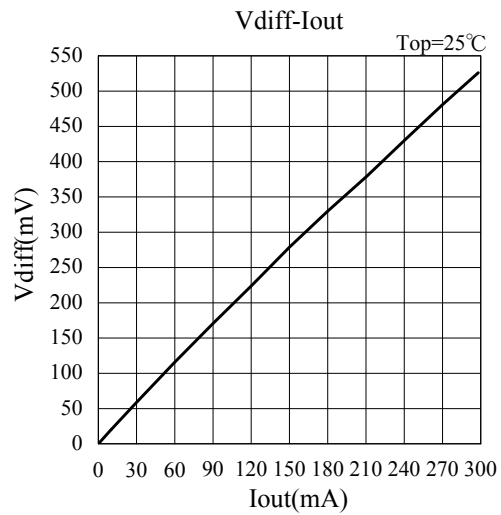
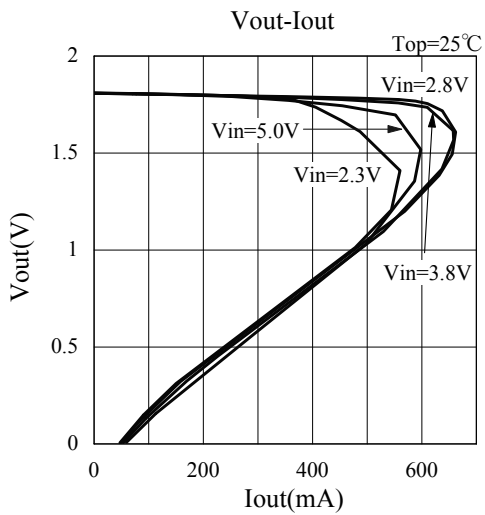
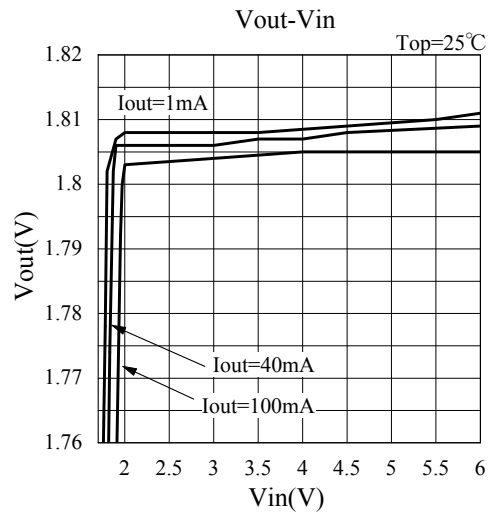
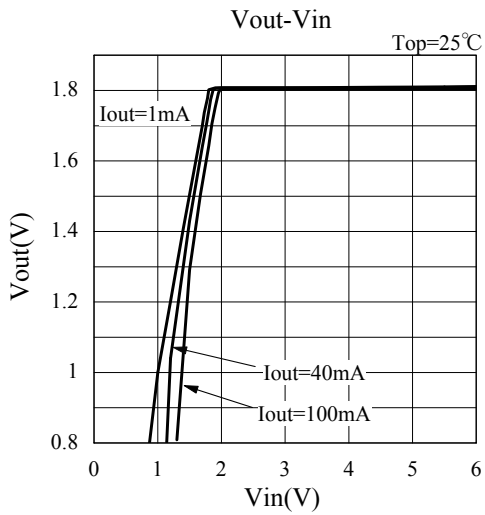

ELM89xxxBC CMOS 300mA LDO Voltage regulator

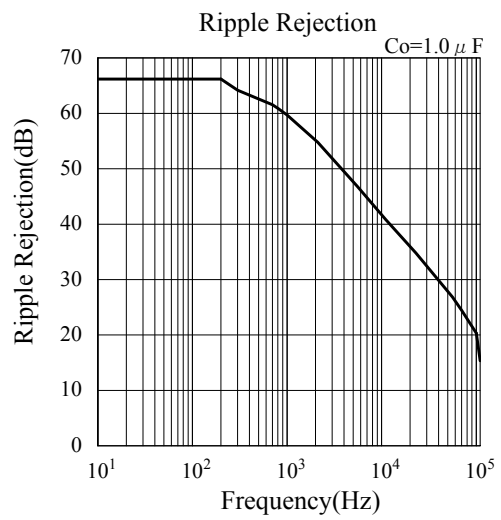
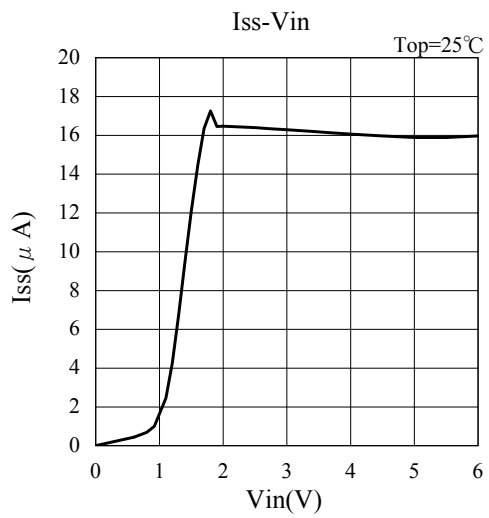
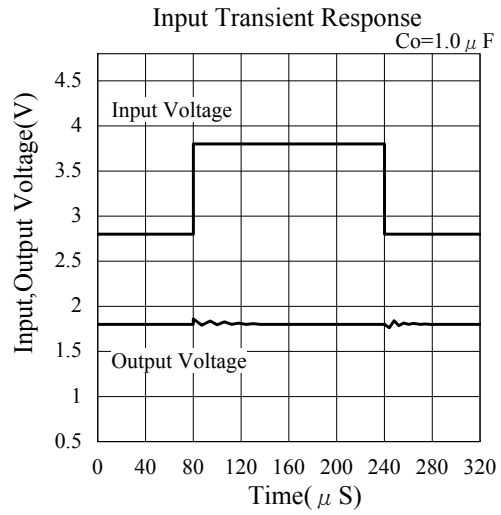
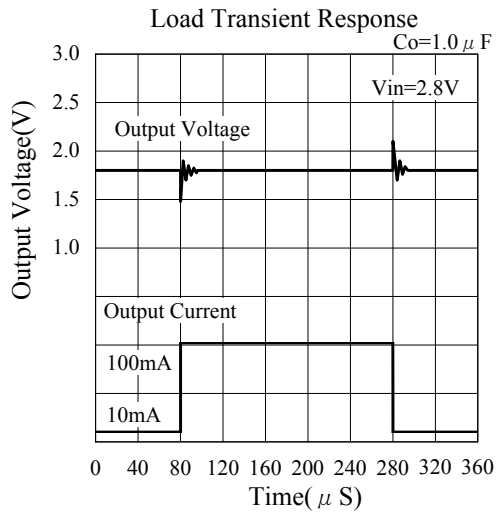

ELM89xxxBC CMOS 300mA LDO Voltage regulator

- 2.5V Vout unit (ELM8925xBC)

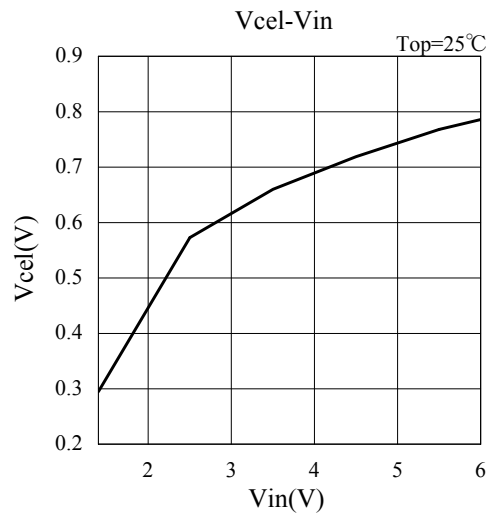
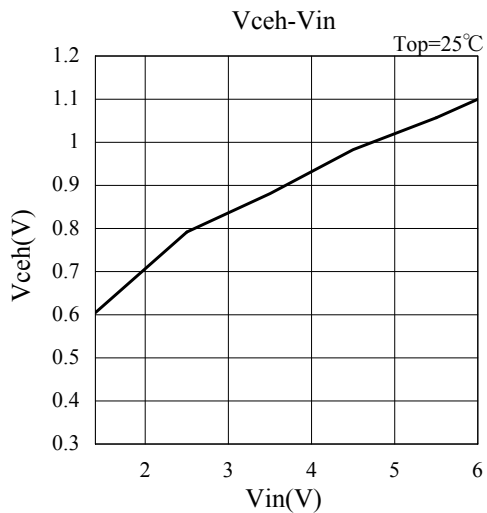
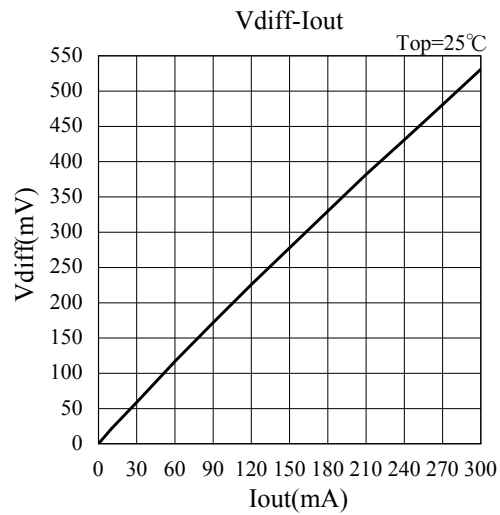
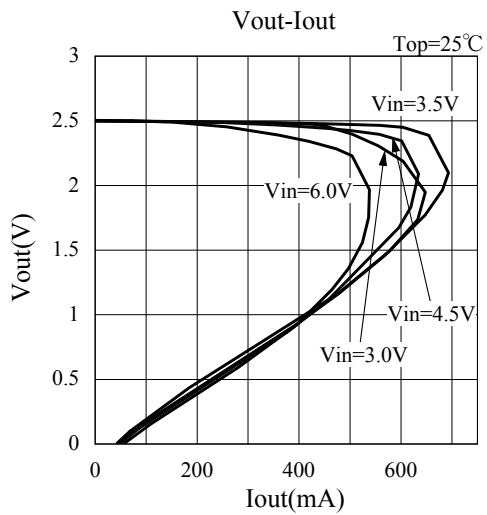
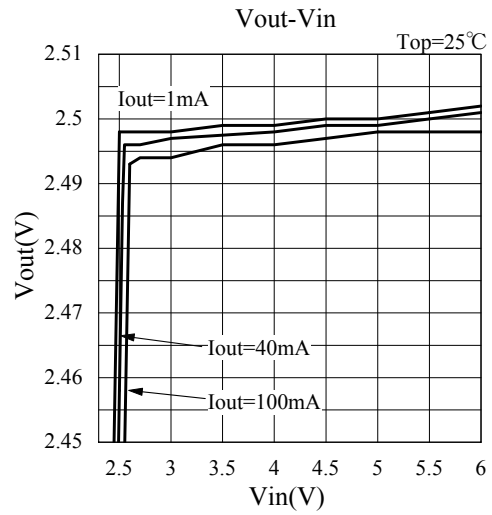
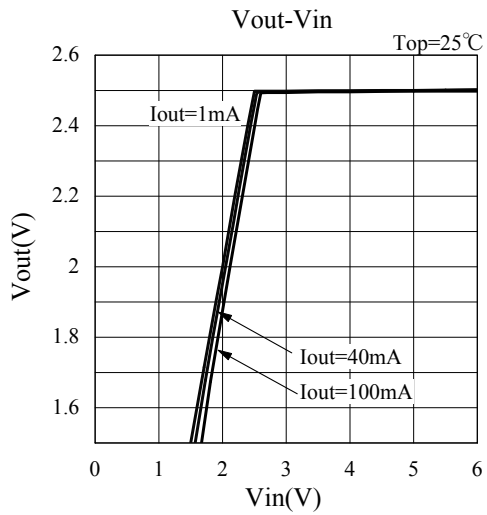

ELM89xxxBC CMOS 300mA LDO Voltage regulator

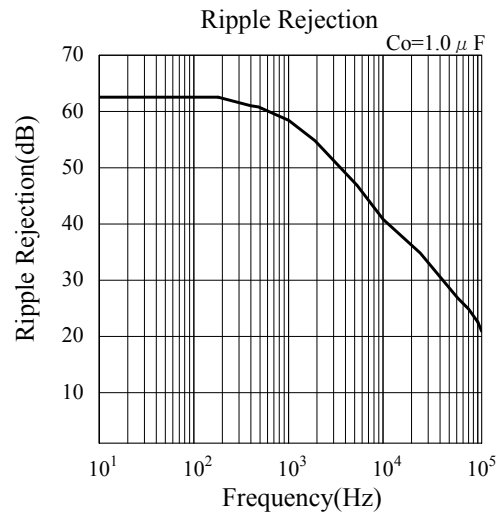
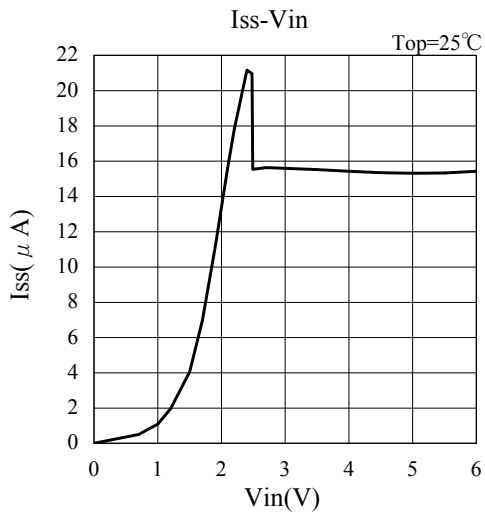
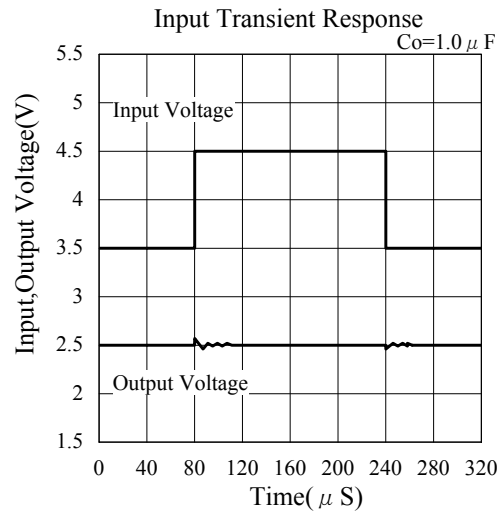
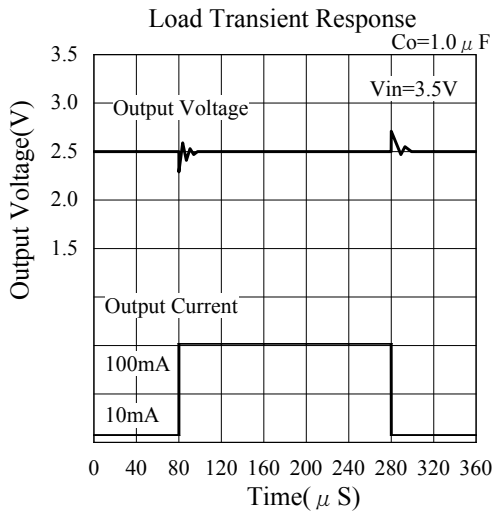

ELM89xxxBC CMOS 300mA LDO Voltage regulator

- 3.0V Vout unit (ELM8930xBC)

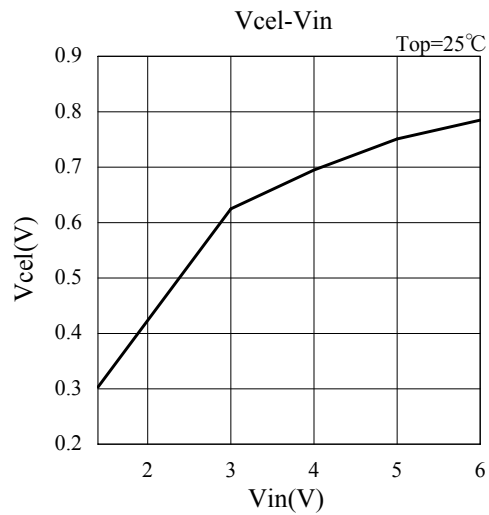
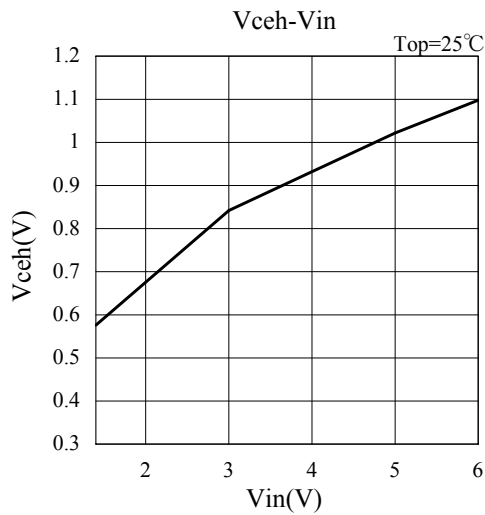
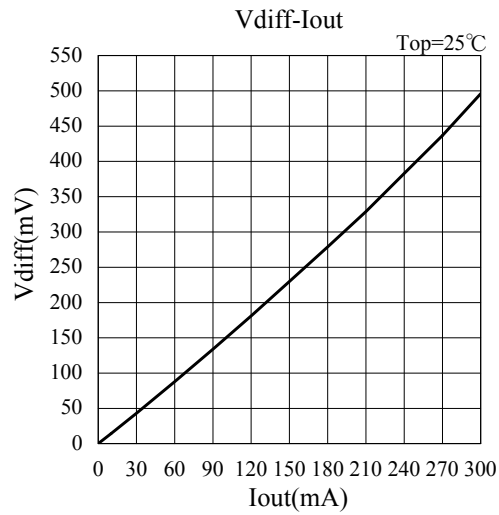
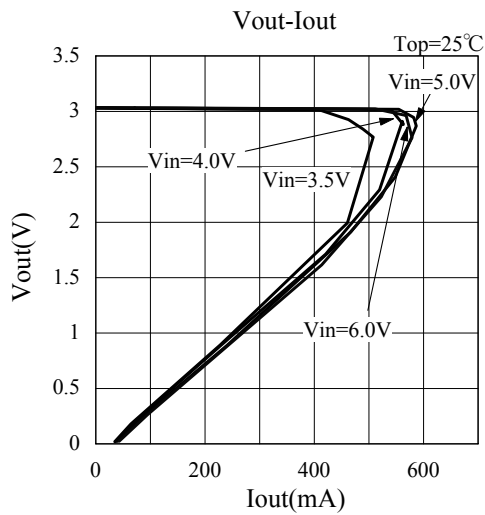
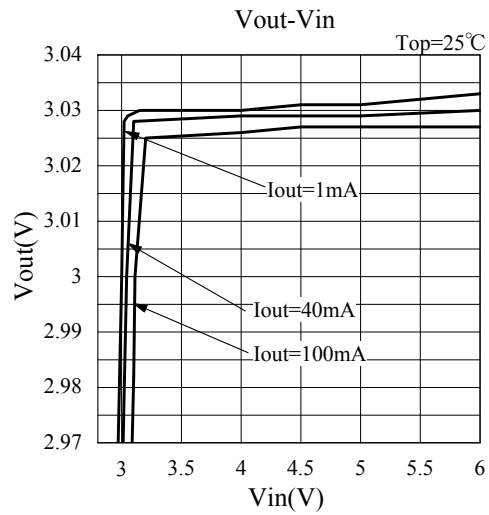
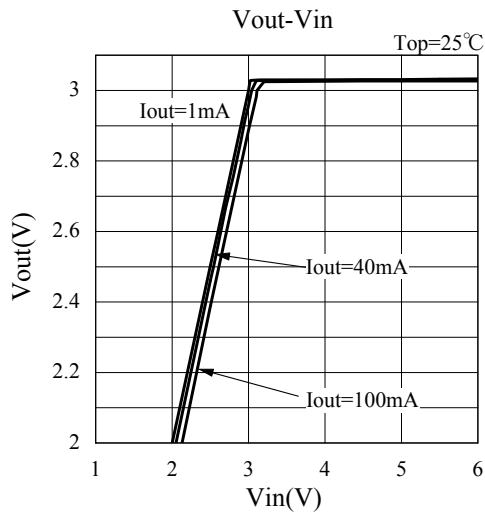

ELM89xxxBC CMOS 300mA LDO Voltage regulator

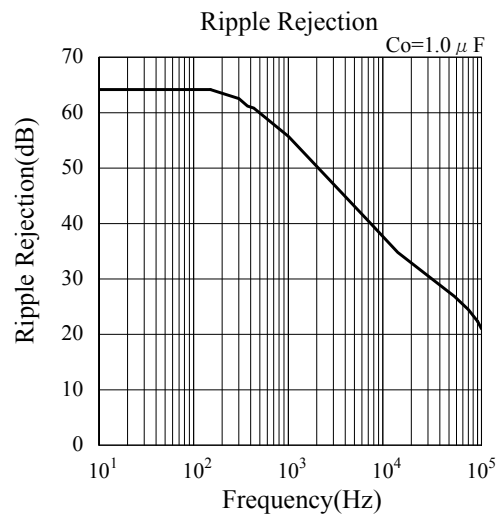
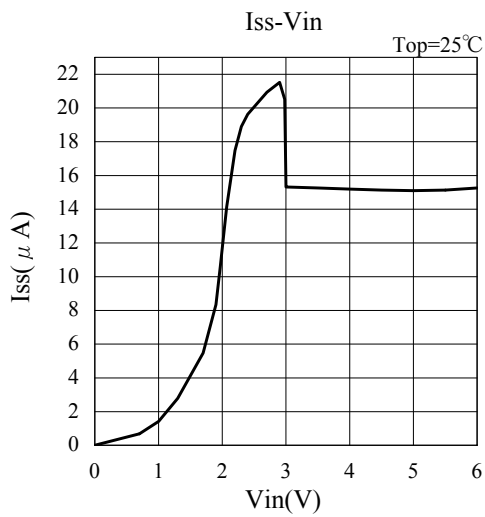
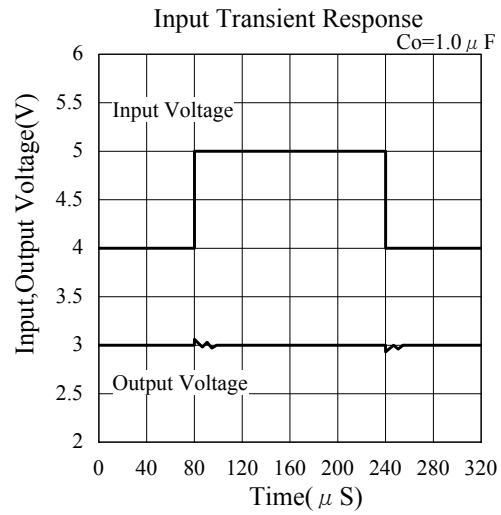
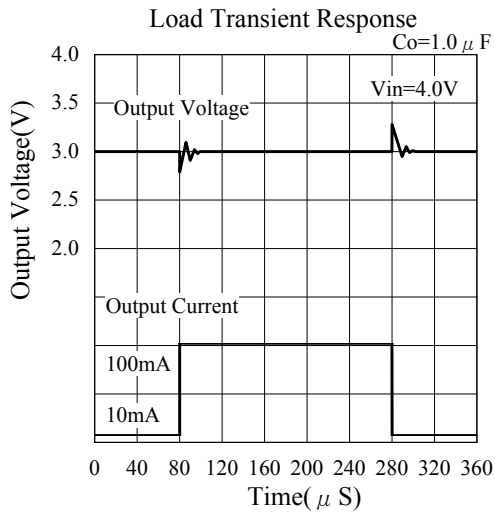

ELM89xxxBC CMOS 300mA LDO Voltage regulator

- 3.3V Vout unit (ELM8933xBC)

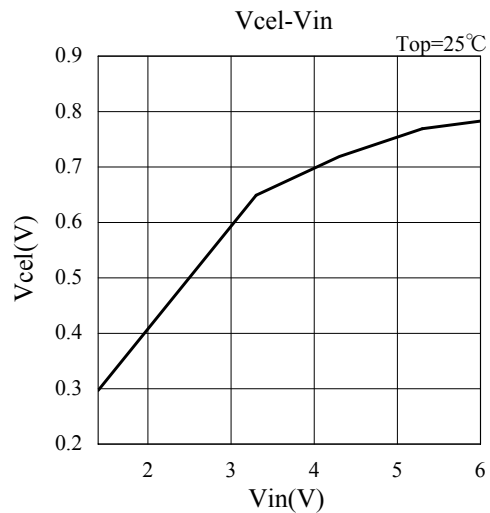
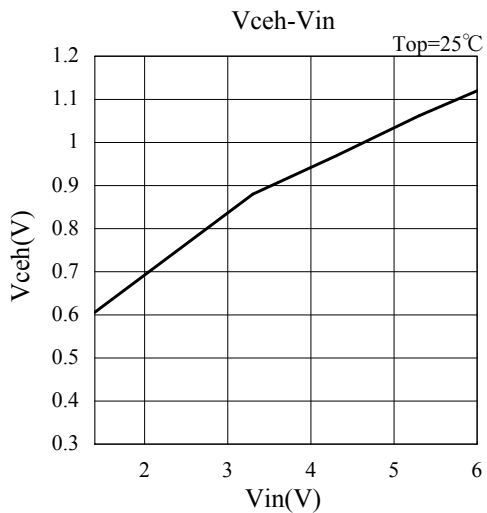
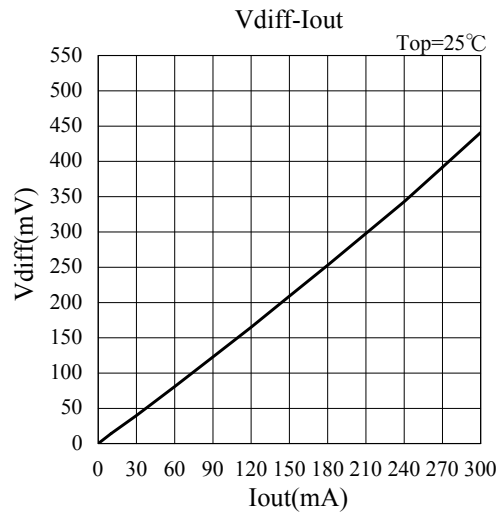
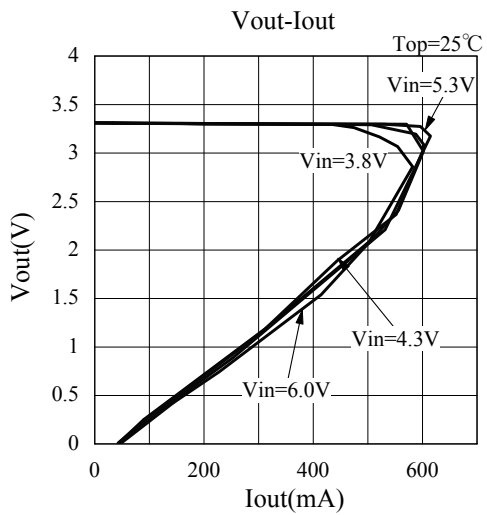
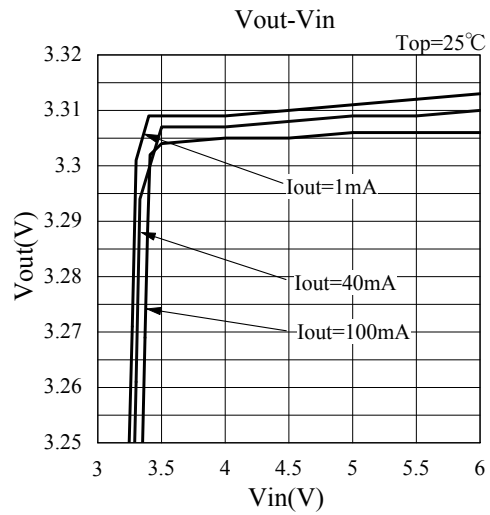
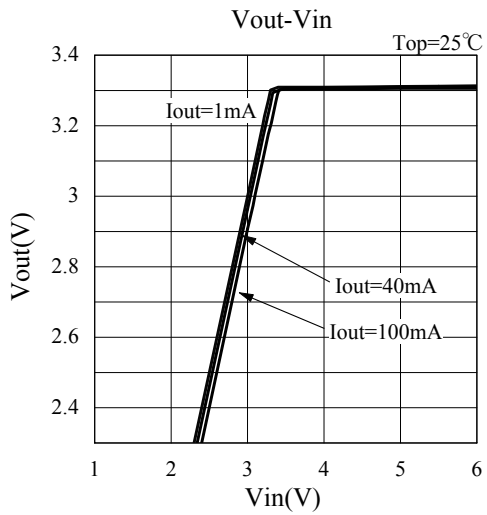

ELM89xxxBC CMOS 300mA LDO Voltage regulator

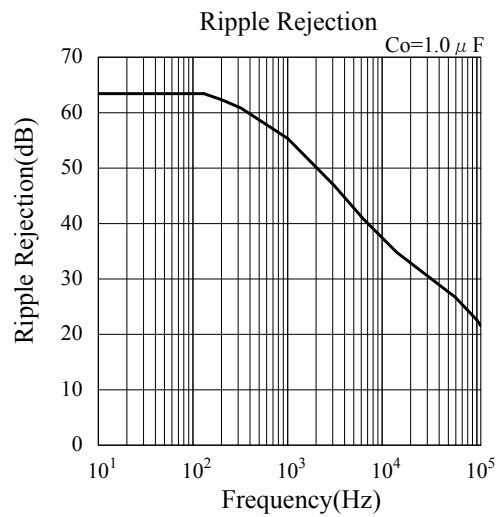
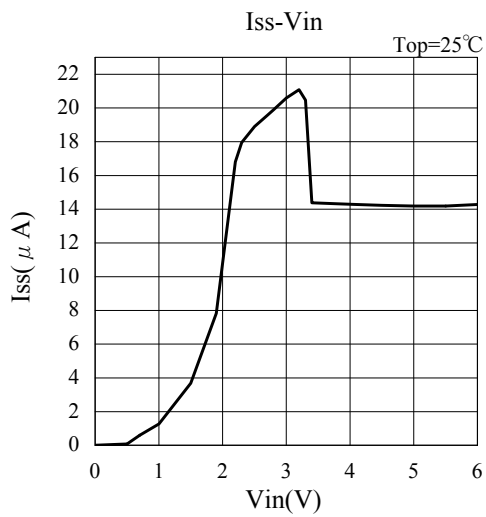
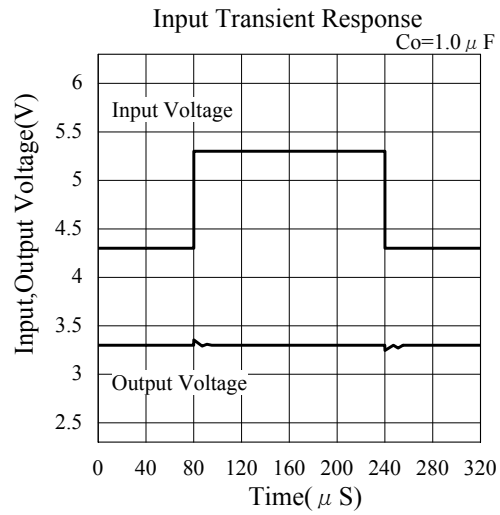
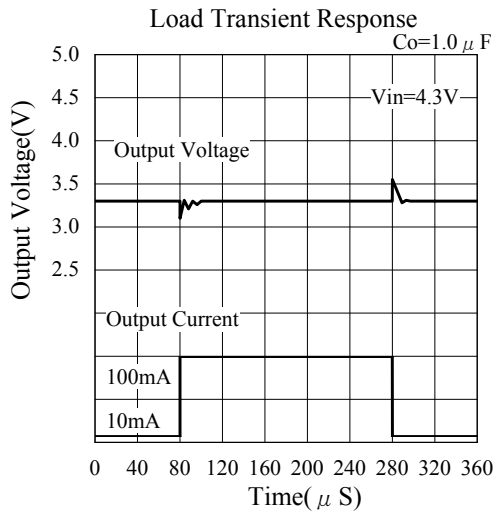

ELM89xxxBC CMOS 300mA LDO Voltage regulator

- 5.0V Vout unit (ELM8950xBC)

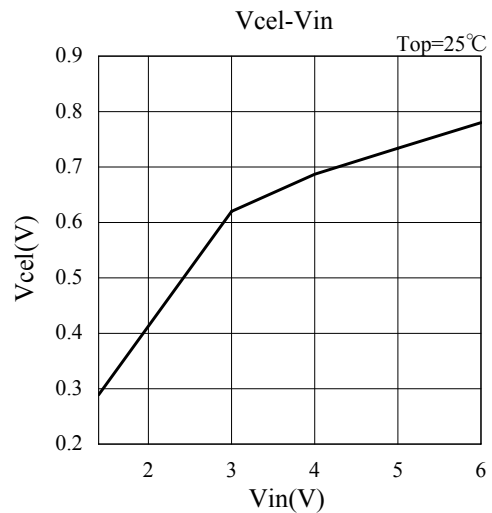
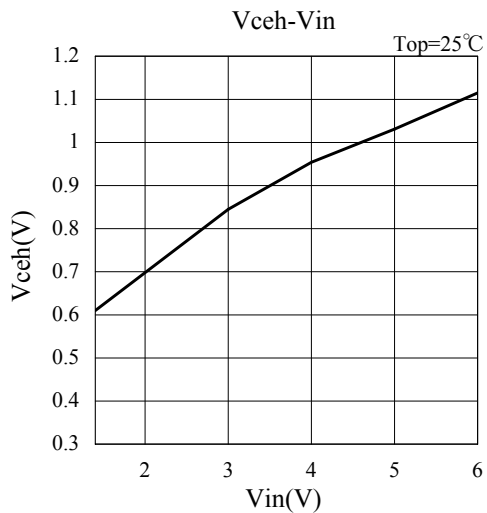
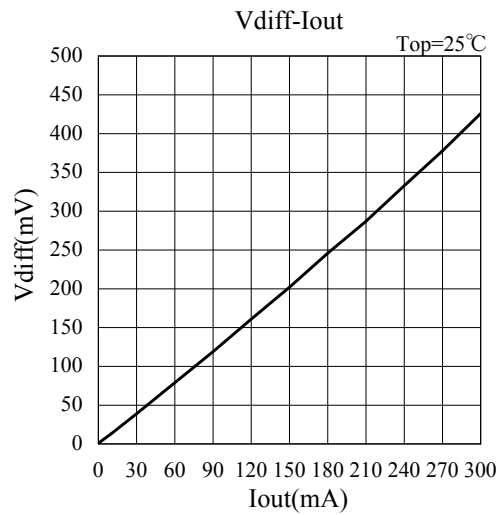
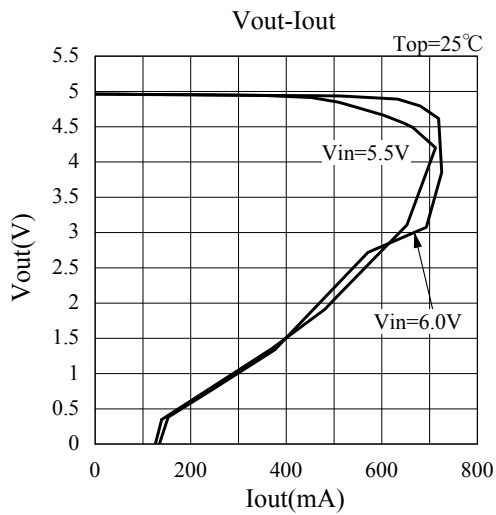
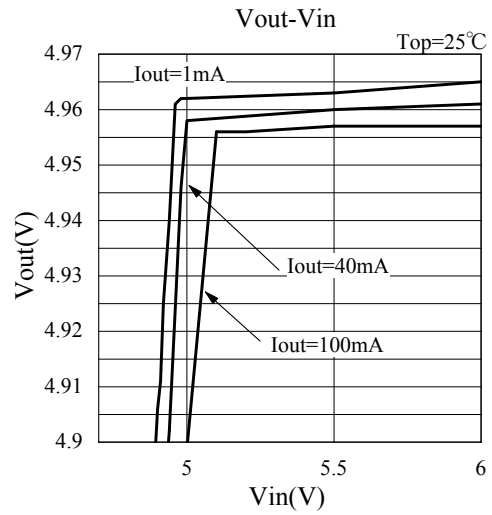
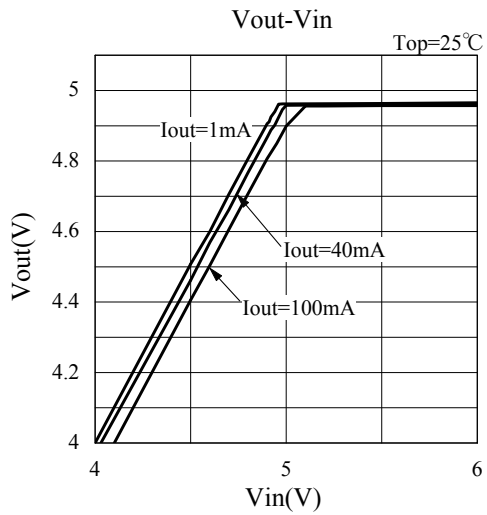

ELM89xxxBC CMOS 300mA LDO Voltage regulator

