

FEATURES

Operates from 1.65 V to 3.6 V supply rails
Unidirectional signal path
Up/down level translation
Ultracompact 6-lead SOT-23 package
Output short-circuit protection
LVTTTL-/CMOS-compatible inputs

APPLICATIONS

Level translation in
PDA's
Handsets
MP3 players

GENERAL DESCRIPTION

The ADG3231 is a single-channel level translator designed on a submicron process that is guaranteed to operate over the 1.65 V to 3.6 V supply range. The device can be used in applications requiring communication between digital devices operating from multiple supply voltages. The logic levels on each side of the device are set by the two supply voltages, V_{CC1} for A and V_{CC2} for Y. The signal path is unidirectional, meaning data can flow only from A to Y.

The ADG3231 can operate with any combination of V_{CC1} and V_{CC2} supply voltages within the 1.65 V to 3.6 V range, allowing the part to perform either up ($V_{CC1} < V_{CC2}$) or down ($V_{CC1} > V_{CC2}$) level translation. The output stage is protected

FUNCTIONAL BLOCK DIAGRAM

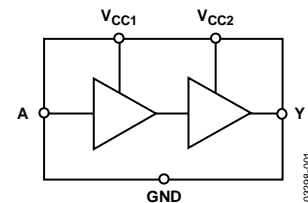

Figure 1.

against current overload, which can occur when the Y pin is accidentally shorted to the V_{CC2} or GND rails.

The ADG3231 is available in the SOT-23 (2.8 mm × 2.9 mm × 1.3 mm) ultracompact package, making the part ideal for applications where space is critical.

PRODUCT HIGHLIGHTS

1. Up/down level translation.
2. Guaranteed to operate with any supply combination within the 1.65 V to 3.6 V range.
3. Output short-circuit protection.
4. Available in ultracompact SOT-23 package.

TABLE OF CONTENTS

Features	1	Absolute Maximum Ratings	4
Applications.....	1	ESD Caution.....	4
Functional Block Diagram	1	Pin Configurations and Function Descriptions	5
General Description	1	Typical Performance Characteristics	6
Product Highlights	1	Theory of Operation	9
Revision History	2	Outline Dimensions	10
Specifications.....	3	Ordering Guide	10

REVISION HISTORY

9/12—Rev. B to Rev. C

Removed SOT-66 Package (Throughout)	1
Updated Outline Dimensions	10
Changes to Ordering Guide	10

5/06—Rev. A to Rev. B

Deleted Figure 11 and Figure 12.....	7
Changes to Ordering Guide	10

12/04—Rev. 0 to Rev. A

Updated Format.....	Universal
Added SOT-66 Package	Universal
Change to Data Sheet Title	1

Changes to Features, Applications, General Description

and Product Highlights Sections.....	1
Changes to Figure 1.....	1
Changes to Table 1.....	3
Changes to Figure 2 and Figure 3.....	3
Deleted TPC 1 to TPC 6.....	6
Changes to Figure 13 through Figure 20.....	7
Changes to Theory of Operation Section.....	9
Updated Outline Dimensions.....	10
Changes to Ordering Guide	10

5/03—Revision 0: Initial Version

SPECIFICATIONS

$V_{CC1} = V_{CC2} = 1.65\text{ V to }3.6\text{ V}$, $GND = 0\text{ V}$. All specifications T_{MIN} to T_{MAX} , unless otherwise noted. Temperature range for the B version is -40°C to $+85^{\circ}\text{C}$.

Table 1.

Parameter	Symbol	Conditions	Min	Typ ¹	Max	Unit
LOGIC INPUTS/OUTPUTS						
Input High Voltage ²	V_{IH}	$V_{CC1} = 3.0\text{ V to }3.6\text{ V}$	1.35			V
		$V_{CC1} = 2.3\text{ V to }2.7\text{ V}$	1.35			V
		$V_{CC1} = 1.65\text{ V to }1.95\text{ V}$	$0.65 V_{CC1}$			V
Input Low Voltage ²	V_{IL}	$V_{CC1} = 3.0\text{ V to }3.6\text{ V}$			0.8	V
		$V_{CC1} = 2.3\text{ V to }2.7\text{ V}$			0.7	V
		$V_{CC1} = 1.65\text{ V to }1.95\text{ V}$			$0.35 V_{CC1}$	V
Output High Voltage	V_{OH}	$I_{OH} = -100\ \mu\text{A}$, $V_{CC2} = 3.0\text{ V to }3.6\text{ V}$	2.4			V
		$I_{OH} = -100\ \mu\text{A}$, $V_{CC2} = 2.3\text{ V to }2.7\text{ V}$	2.0			V
		$I_{OH} = -100\ \mu\text{A}$, $V_{CC2} = 1.65\text{ V to }1.95\text{ V}$	$V_{CC2} - 0.45$			V
		$I_{OH} = -4\text{ mA}$, $V_{CC2} = 2.3\text{ V to }2.7\text{ V}$	2.0			V
		$I_{OH} = -4\text{ mA}$, $V_{CC2} = 1.65\text{ V to }1.95\text{ V}$	$V_{CC2} - 0.45$			V
		$I_{OH} = -8\text{ mA}$, $V_{CC2} = 3.0\text{ V to }3.6\text{ V}$	2.4			V
Output Low Voltage	V_{OL}	$I_{OL} = 100\ \mu\text{A}$, $V_{CC2} = 3.0\text{ V to }3.6\text{ V}$			0.4	V
		$I_{OL} = 100\ \mu\text{A}$, $V_{CC2} = 2.3\text{ V to }2.7\text{ V}$			0.4	V
		$I_{OL} = 100\ \mu\text{A}$, $V_{CC2} = 1.65\text{ V to }1.95\text{ V}$			0.45	V
		$I_{OL} = 4\text{ mA}$, $V_{CC2} = 2.3\text{ V to }2.7\text{ V}$			0.4	V
		$I_{OL} = 4\text{ mA}$, $V_{CC2} = 1.65\text{ V to }1.95\text{ V}$			0.45	V
		$I_{OL} = 8\text{ mA}$, $V_{CC2} = 3.0\text{ V to }3.6\text{ V}$			0.4	V
SWITCHING CHARACTERISTICS ²						
Propagation Delay, t_{PD} A to Y	t_{PHL} , t_{PLH}	$3.3\text{ V} \pm 0.3\text{ V}$, $C_L = 30\text{ pF}$, see Figure 2		4	6.5	ns
Propagation Delay, t_{PD} A to Y	t_{PHL} , t_{PLH}	$2.5\text{ V} \pm 0.2\text{ V}$, $C_L = 30\text{ pF}$, see Figure 2		4.5	6.5	ns
Propagation Delay, t_{PD} A to Y	t_{PHL} , t_{PLH}	$1.8\text{ V} \pm 0.15\text{ V}$, $C_L = 30\text{ pF}$, see Figure 2		6.5	10.25	ns
Input Leakage Current	I_I	$0 \leq V_{IN} \leq 3.6\text{ V}$			± 1	μA
Output Leakage Current	I_O	$0 \leq V_{IN} \leq 3.6\text{ V}$			± 1	μA
POWER REQUIREMENTS						
Power Supply Voltages	V_{CC1}		1.65		3.6	V
	V_{CC2}		1.65		3.6	V
Quiescent Power Supply Current	I_{CC1}	Digital inputs = 0 V or V_{CC1}			2	μA
	I_{CC2}	Digital inputs = 0 V or V_{CC2}			2	μA

¹ All typical values are at $V_{CC1} = V_{CC2}$, $T_A = 25^{\circ}\text{C}$, unless otherwise noted.

² Guaranteed by design, not subject to production test.

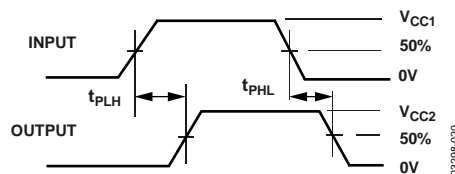

Figure 2. Timing Diagram

ABSOLUTE MAXIMUM RATINGS

$T_A = 25^\circ\text{C}$, unless otherwise noted.

Table 2.

Parameter	Rating
V_{CC} to GND	-0.3 V to +4.6 V
Input Voltage for A	-0.3 V to $V_{CC1} + 0.3$ V
DC Output Current	25 mA
Operating Temperature Range Industrial (B Version)	-40°C to +85°C
Storage Temperature Range	-65°C to +150°C
Junction Temperature	150°C
θ_{JA} Thermal Impedance 6-Lead SOT-23	229°C/W
Lead Temperature, Soldering (10 sec)	300°C
IR Reflow, Peak Temperature (<20 sec)	235°C

Stresses above those listed under Absolute Maximum Ratings may cause permanent damage to the device. This is a stress rating only; functional operation of the device at these or any other conditions above those indicated in the operational section of this specification is not implied. Exposure to absolute maximum rating conditions for extended periods may affect device reliability.

Only one absolute maximum rating may be applied at any one time.

ESD CAUTION



ESD (electrostatic discharge) sensitive device. Charged devices and circuit boards can discharge without detection. Although this product features patented or proprietary protection circuitry, damage may occur on devices subjected to high energy ESD. Therefore, proper ESD precautions should be taken to avoid performance degradation or loss of functionality.

PIN CONFIGURATIONS AND FUNCTION DESCRIPTIONS

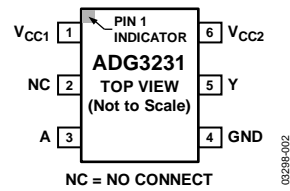

Figure 3. SOT-23

Table 3. Pin Function Descriptions

Pin Number	Mnemonic	Description
1	V _{CC1}	Supply Voltage 1. Can be any supply voltage from 1.65 V to 3.6 V.
2	NC	Not internally connected.
3	A	Digital Input Referred to V _{CC1} .
4	GND	Device Ground Pin.
5	Y	Digital Output Referred to V _{CC2} .
6	V _{CC2}	Supply Voltage 2. Can be any supply voltage from 1.65 V to 3.6 V.

TYPICAL PERFORMANCE CHARACTERISTICS

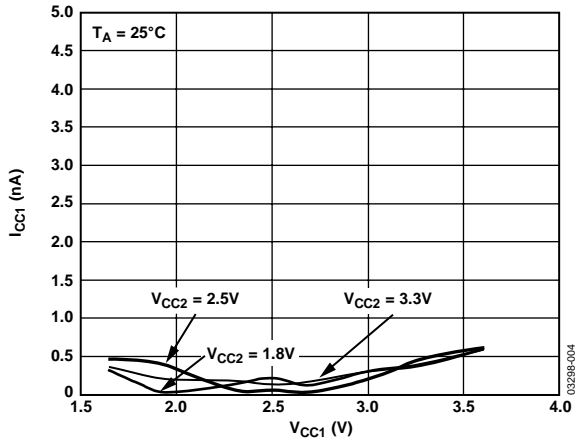

Figure 4. I_{CC1} vs. V_{CC1}

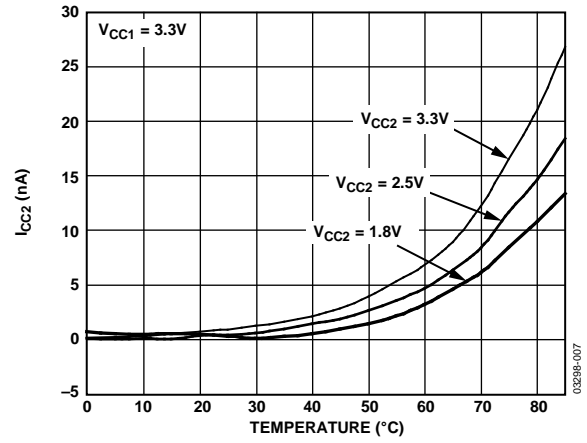

Figure 7. I_{CC2} vs. Temperature

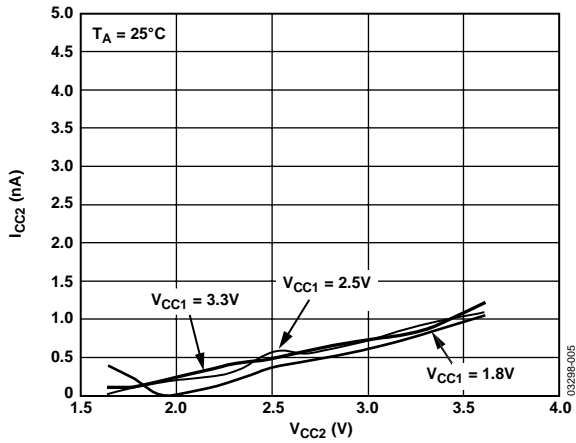

Figure 5. I_{CC2} vs. V_{CC2}

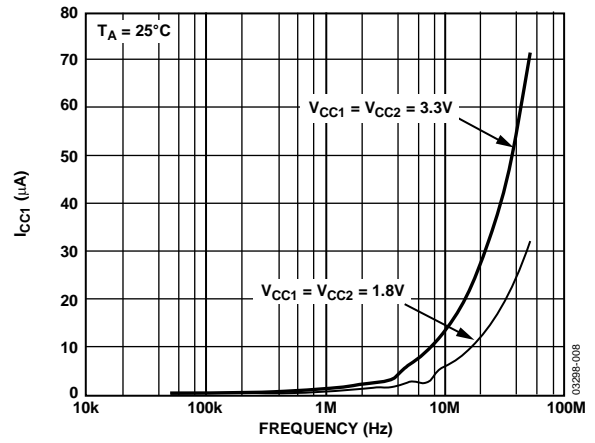

Figure 8. I_{CC1} vs. Frequency

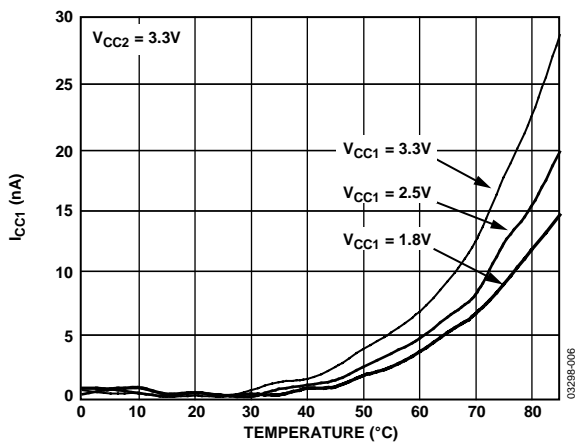

Figure 6. I_{CC1} vs. Temperature

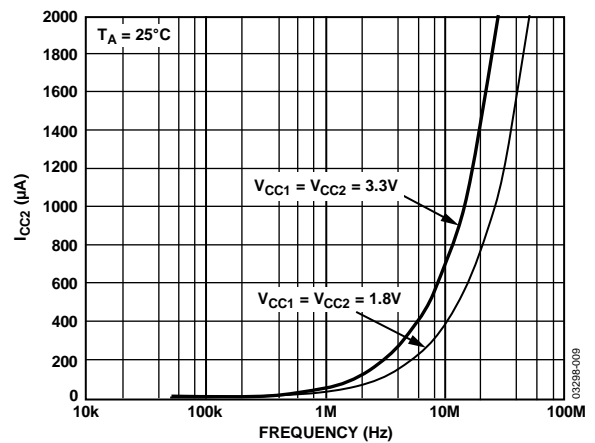

Figure 9. I_{CC2} vs. Frequency

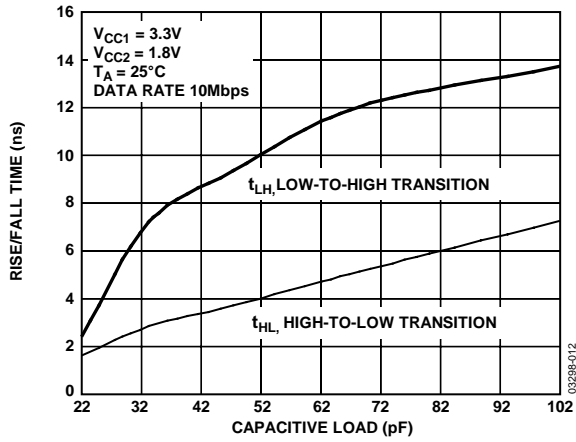

Figure 10. Rise/Fall Time vs. Capacitive Load (3.3 V to 1.8 V Level Translation)

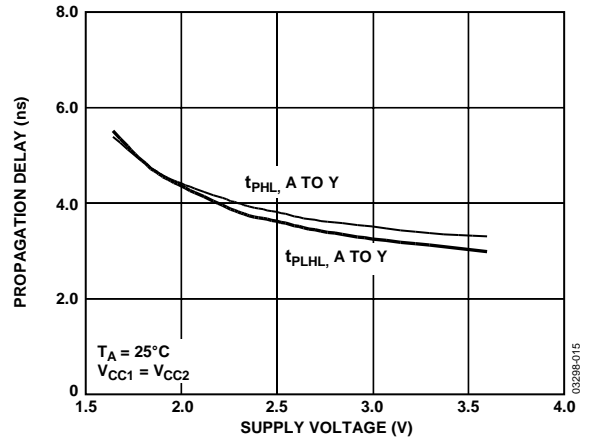

Figure 13. Propagation Delay vs. Supply Voltage

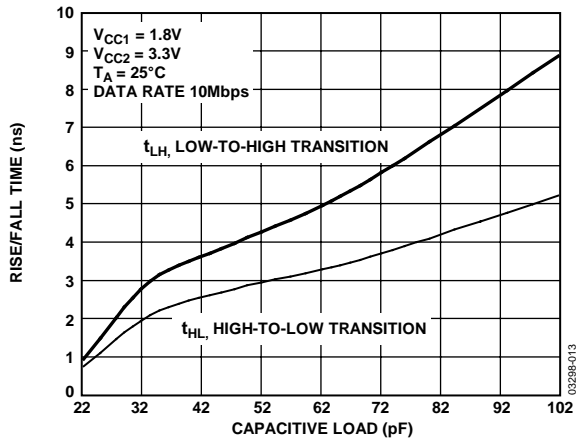

Figure 11. Rise/Fall Time vs. Capacitive Load (1.8 V to 3.3 V Level Translation)

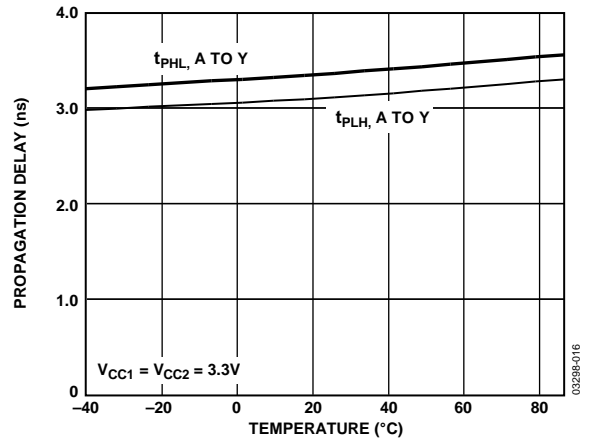

Figure 14. Propagation Delay vs. Temperature

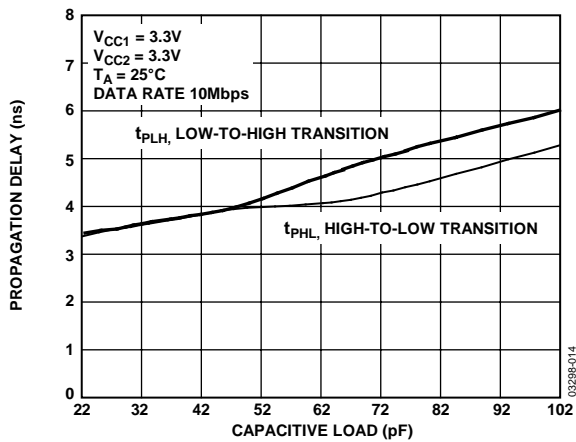

Figure 12. Propagation Delay vs. Capacitive Load

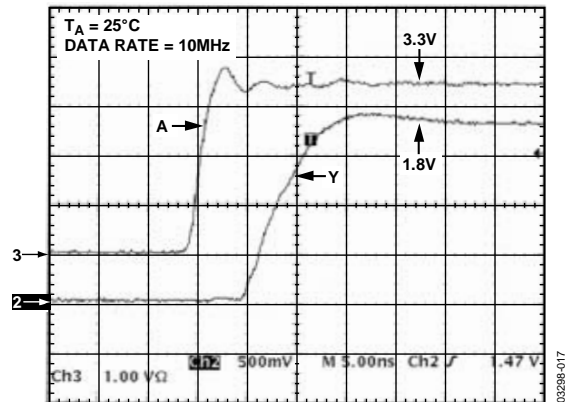

Figure 15. Input/Output $V_{CC1} = 3.3V$, $V_{CC2} = 1.8V$

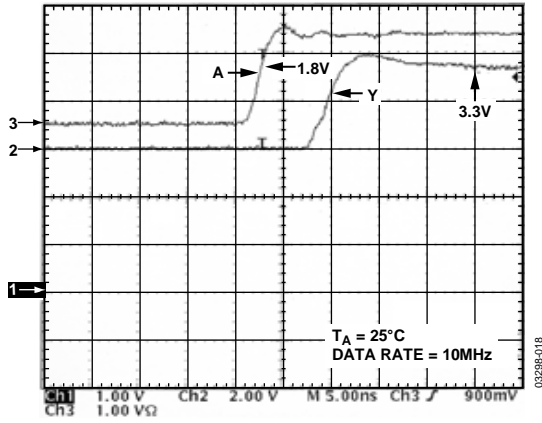

Figure 16. Input/Output $V_{CC1} = 1.8V$, $V_{CC2} = 3.3V$

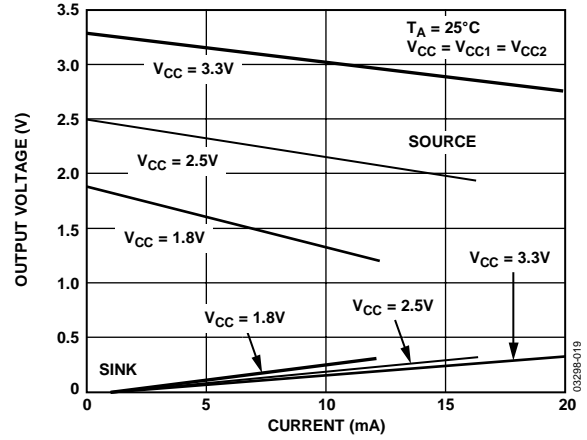

Figure 17. Output Voltage vs. Sink and Source Current

THEORY OF OPERATION

The ADG3231 is a single-channel level translator designed on a submicron process that is guaranteed to operate over the 1.65 V to 3.6 V supply range. The device can be used in applications requiring communication between digital devices operating from multiple supply voltages. The logic levels on each side of the device are set by the two supply voltages, V_{CC1} for A, and V_{CC2} for Y. The signal path is unidirectional, meaning data can flow only from A to Y.

The ADG3231 can operate with any combination of V_{CC1} and V_{CC2} supply voltages within the 1.65 V to 3.6 V range, allowing the part to perform either up ($V_{CC1} < V_{CC2}$) or down ($V_{CC1} > V_{CC2}$) level translation.

By limiting the current delivered into the load, for example, ~ 1.7 mA with $V_{CC2} = 3.6$ V, the output stage is protected against current overload, which can occur when the Y pin is accidentally shorted to the V_{CC2} or GND rails.

The short-circuit protection circuitry works by limiting the output current when the output voltage exceeds V_{OL} ($A = 0$ logic) or is less than V_{OH} ($A = 1$ logic) threshold values specified for the V_{CC2} supply voltage used.

Figure 18 shows a typical application for the ADG3231 where the device performs level translation from V_{CC1} -compatible levels to V_{CC2} -compatible levels to allow proper communication between the two digital devices, DEVICE 1 and DEVICE 2.

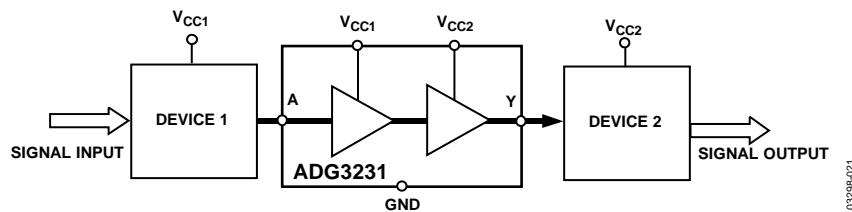
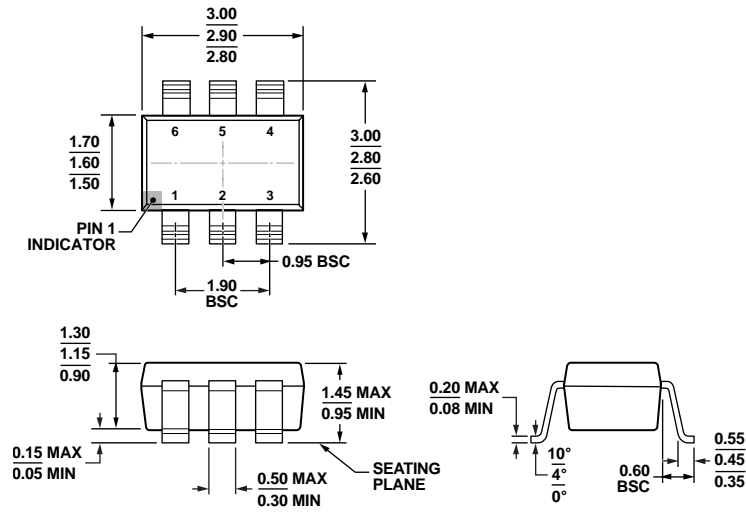

Figure 18. Typical Application of the ADG3231 Level Translator

OUTLINE DIMENSIONS



COMPLIANT TO JEDEC STANDARDS MO-178-AB
 Figure 19. 6-Lead Small Outline Transistor Package [SOT-23]
 (RJ-6)
 Dimensions shown in millimeters

12-16-2005-A

ORDERING GUIDE

Model ¹	Temperature Range	Package Description	Package Option	Branding
ADG3231BRJ-REEL7	-40°C to +85°C	6-Lead SOT-23	RJ-6	W2B
ADG3231BRJZ-REEL	-40°C to +85°C	6-Lead SOT-23	RJ-6	W2B #
ADG3231BRJZ-REEL7	-40°C to +85°C	6-Lead SOT-23	RJ-6	W2B #

¹ Z = RoHS Compliant Part, # denotes lead-free may be top or bottom marked.

NOTES

NOTES