

CLICKER 2 ^{STM32}

a fast click™ board two-seater

A compact starter kit
with your favorite
microcontroller and two
mikroBUS™ sockets



TO OUR VALUED CUSTOMERS

I want to express my thanks to you for being interested in our products and for having confidence in MikroElektronika.

The primary aim of our company is to design and produce high quality electronic products and to constantly improve the performance thereof in order to better suit your needs.

A white, handwritten signature in cursive script, appearing to read 'N. Matic', is positioned on the right side of the page.

Nebojsa Matic
General Manager

Table of contents

Introduction to clicker 2 for STM32	4	3.2 Programming with mikroProg™ programmer	15
Key features	5	mikroProg Suite™ for ARM® software	16
1. Power supply	7	3.3 Programming with ST-LINK V2 programmer	17
2. STM32F407VGT6 microcontroller	9	4. Buttons and LEDs	19
Key microcontroller features	9	5. Power management and battery charger	21
3. Programming the microcontroller	10	6. Oscillators	22
3.1 Programming with mikroBootloader	11	7. USB connection	24
step 1 - Connecting clicker 2 for STM32	11	8. Pads	26
step 2 - Browsing for .HEX file	12	9. Pinout	27
step 3 - Selecting .HEX file	12	9.1 mikroBUS™ pinout	28
step 4 - Uploading .HEX file	13	10. click™ boards are plug and play!	29
step 5 - Finish upload	14	11. Dimensions	31

Introduction to clicker 2 for STM32

clicker 2 for STM32 is a compact dev. kit with two mikroBUS™ sockets for click board connectivity. You can use it to quickly build your own gadgets with unique functionalities and features. It carries the STM32F407VGT6, a 32-bit ARM® Cortex®-M4 microcontroller, two indication LEDs, two general purpose buttons, a reset button, an on/off switch, a li-polymer battery connector, a USB Mini-B connector and two mikroBUS™ socket. A JTAG connector and a 2x26 pinout for interfacing with external electronics are also provided. The mikroBUS™ connector consists of two 1x8 female headers with SPI, I²C, UART, RST, PWM, Analog and Interrupt lines as well as 3.3V, 5V and GND power lines. Clicker 2 for STM32 board can be powered over a USB cable.

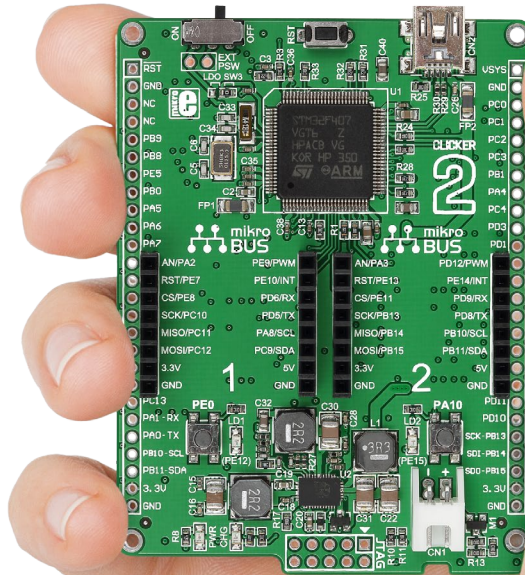

Key features

- 1 ON/OFF switch
- 2 Pads for connecting external ON/OFF switch
- 3 Jumper for enabling RTC power supply
- 4 25 MHz crystal oscillator
- 5 32.768 KHz crystal oscillator
- 6 2x26 connection pads
- 7 mikroBUS™ sockets 1 and 2
- 8 Pushbuttons
- 9 Additional LEDs
- 10 LTC3586 USB power manager IC
- 11 Indication LEDs
- 12 RESET button
- 13 USB mini-B connector
- 14 STM32F407VGT6
- 15 Battery connector
- 16 JTAG programmer connector

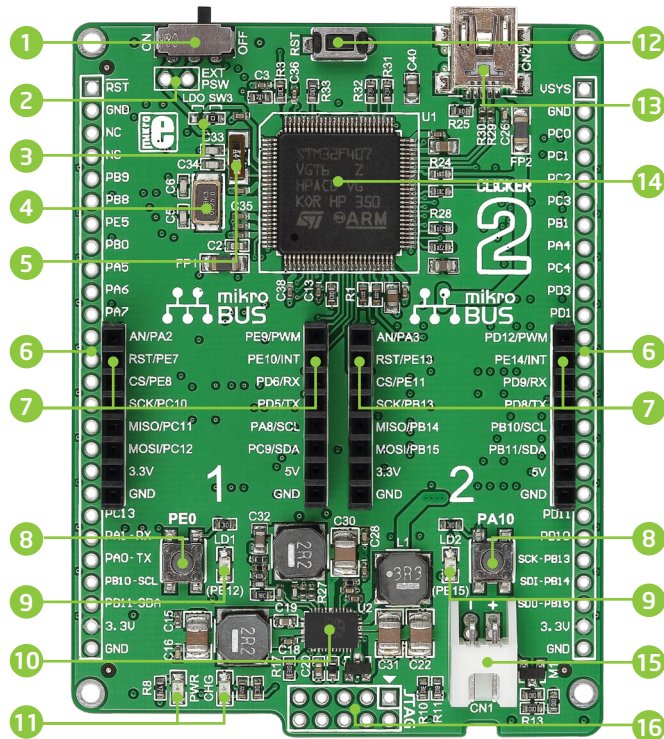

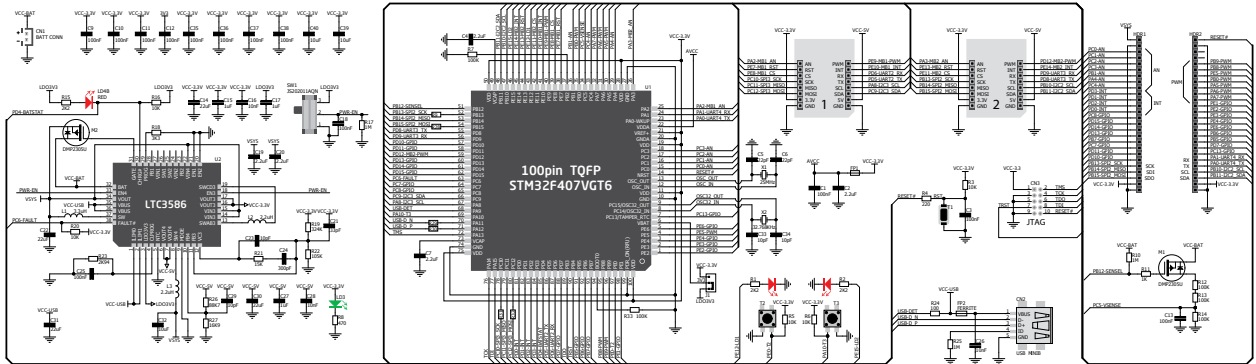

clicker 2 for STM32 schematic

1. Power supply

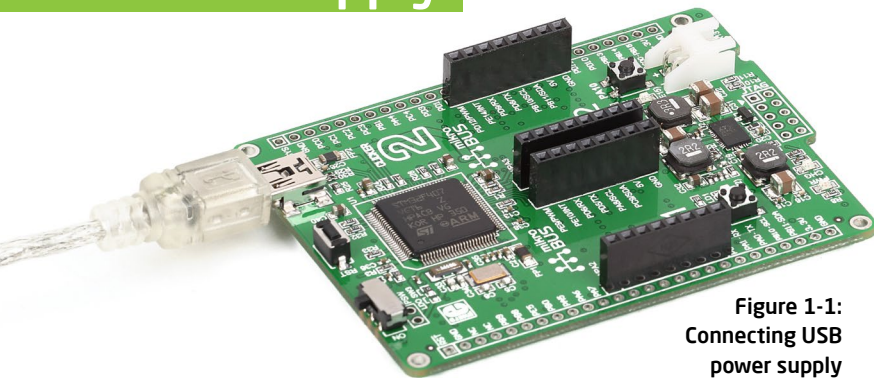

Figure 1-1:
Connecting USB
power supply

USB power supply

You can supply power to the board with a **Mini-B USB** cable provided in the package. On-board voltage regulators provide the appropriate voltage levels to each component on the board. **Power LED (GREEN)** will indicate the presence of power supply.

Battery power supply

You can also power the board using a **Li-Polymer** battery, via on-board battery connector. On-board battery charger circuit enables you to charge the battery over USB connection. **LED diode (RED)** will indicate when battery is charging. Charging current is ~300mA and charging voltage is 4.2V DC.

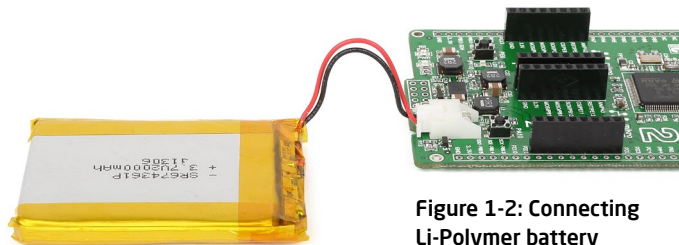

Figure 1-2: Connecting
Li-Polymer battery

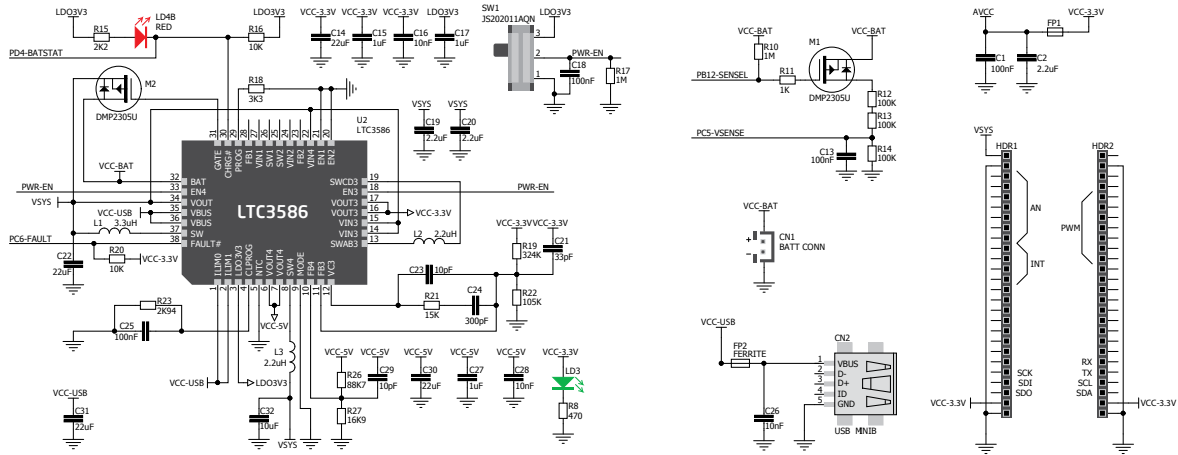

Figure 1-3: Power supply schematic

2. STM32F407VGT6 microcontroller

The clicker 2 for STM32 development tool comes with the **STM32F407VGT6** device. This 32-bit high performance microcontroller is rich with on-chip peripherals and features 1 MB of Flash and 192+4 KB of SRAM. It has integrated full speed USB 2.0. support.

Key microcontroller features

- 16-bit and 32-bit Timers, up to 168Mhz
- 32-bit ARM® Cortex®-M4 architecture
- 1 MB of Flash memory
- 192 +4 KB SRAM
- 3x 12-bit ADC
- Internal Oscillator 25MHz, 32kHz, PLL;
- SPI, I²C, CAN, USB, USART, UART, RTC, Ethernet

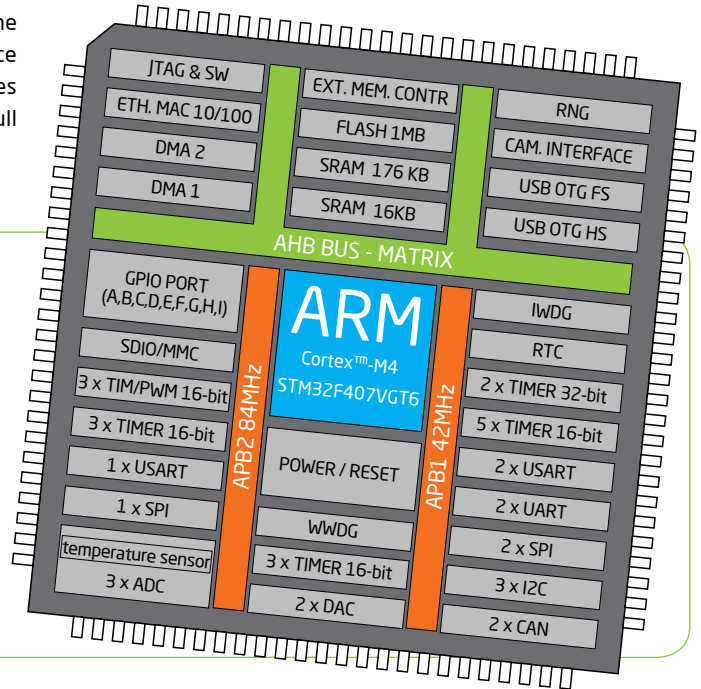

3. Programming the microcontroller

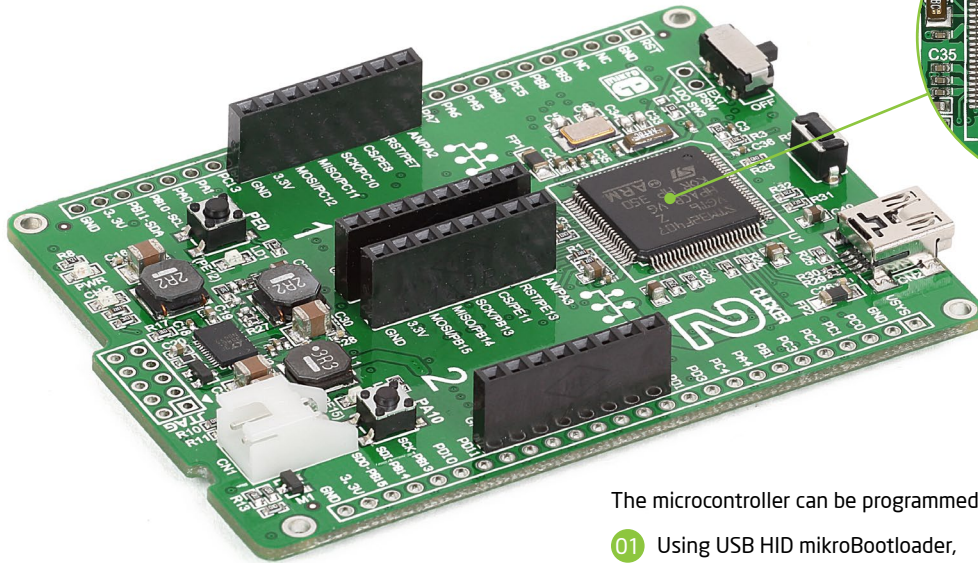

Figure 3-1:
STM32F407VGT6
microcontroller

The microcontroller can be programmed in three ways:

- 01 Using USB HID mikroBootloader,
- 02 Using external mikroProg™ for STM32 programmer
- 03 Using external ST-LINK V2™ programmer

3.1 Programming with mikroBootloader

You can program the microcontroller with a bootloader which is preprogrammed by default. To transfer .hex file from a PC to MCU you need bootloader software (**mikroBootloader USB HID**) which can be downloaded from:



www.mikroe.com/downloads/get/2153/mikrobootloader_usb_hid_STM32F407VGT6.zip

After the mikroBootloader software is downloaded, unzip it to desired location and start it.

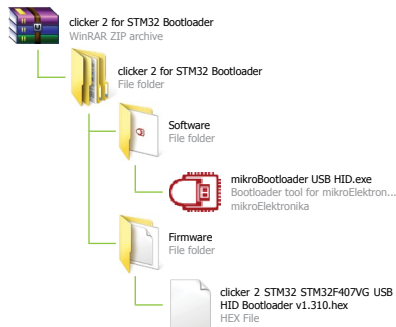

step 1 - Connecting clicker 2 for STM32



Figure 3-2: USB HID mikroBootloader window

- 01 To start, connect the USB cable, or if already connected press the **Reset** button on your clicker 2 for STM32. Click the **Connect** button within 5s to enter the bootloader mode, otherwise existing microcontroller program will execute.

step 2 - Browsing for .HEX file



Figure 3-3: Browse for HEX

- 01 Click the **Browse for HEX** button and from a pop-up window (**Figure 3.4**) choose the .HEX file which will be uploaded to MCU memory.

step 3 - Selecting .HEX file

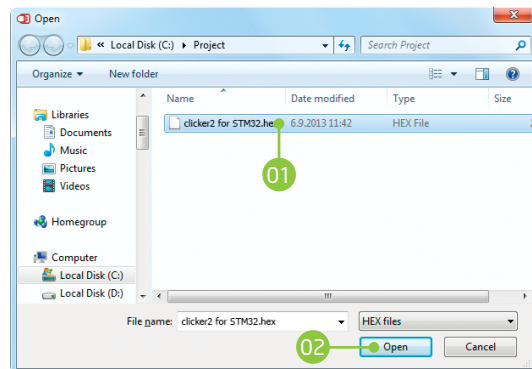

Figure 3-4: Selecting HEX

- 01 Select .HEX file using open dialog window.
- 02 Click the **Open** button.

step 4 - Uploading .HEX file



Figure 3-5: Begin uploading

01 To start .HEX file bootloading click the **Begin uploading** button.



Figure 3-6: Progress bar

01 Progress bar enables you to monitor .HEX file uploading.

step 5 - Finish upload

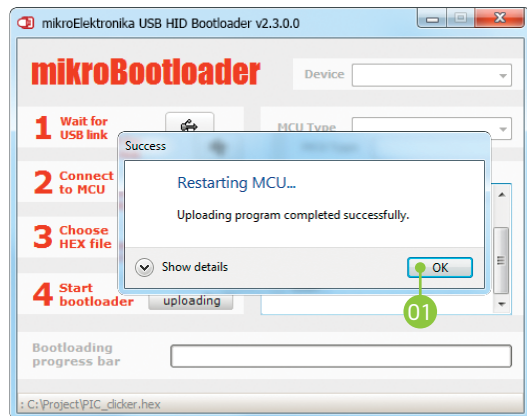

Figure 3-7: Restarting MCU

- 01 Click **OK** button after the uploading process is finished.
- 02 Press **Reset** button on clicker 2 for STM32 board and wait for 5 seconds. Your program will run automatically.

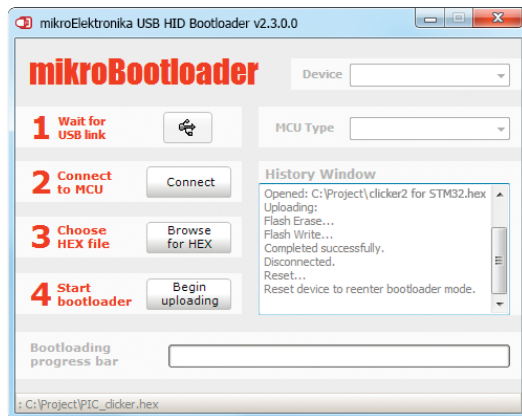

Figure 3-8: mikroBootloader ready for next job

3.2 Programming with mikroProg™ programmer

The microcontroller can be programmed with external **mikroProg™ for STM32 programmer** and **mikroProg Suite™ for ARM® software**.

The external programmer is connected to the development system via 2x5 JTAG connector soldered on the CN3 connector pads, **Figure 3-9**.

mikroProg™ is a fast USB 2.0 programmer with hardware debugger support. It supports STM32 M3 and M4 devices from STMicroelectronics.

Outstanding performance, easy operation and elegant design are its key features.



Figure 3-9: mikroProg™ connector

mikroProg Suite™ for ARM® software

On-board mikroProg™ programmer requires special programming software called mikroProg Suite™ for ARM®. This software is used for programming of all supported microcontroller families with ARM® Cortex™-M3 and Cortex™-M4 cores. The software has an intuitive interface and SingleClick™ programming technology. To begin, first locate the installation archive on the link below:



http://www.mikroe.com/downloads/get/1809/mikroprog_suite_for_arm.zip

After downloading, extract the package and double click the executable setup file, to start installation.

Quick guide

- 01 Click the **Detect MCU** button in order to recognize the device ID.
- 02 Click the **Read** button to read the entire microcontroller memory. You can click the **Save** button to save it to the target HEX file.
- 03 If you want to write the HEX file into the microcontroller, first make sure to load the target HEX file using the **Load** button. Then click the **Write** button to begin programming.
- 04 Click the **Erase** button to clear the microcontroller memory.

Figure 3-10:
mikroProg Suite™
for ARM® window

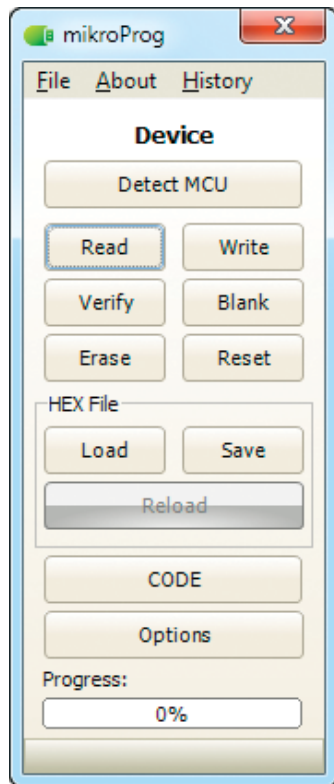

3.3 Programming with ST-LINK V2 programmer

The microcontroller can also be programmed with the **ST-LINK V2 programmer** and **mikroProg Suite™ for ARM®** software. This programmer connects with the clicker 2 board via **mikroProg to ST-LINK V2 adapter** (Figure 3-11).

Figure 3-11:
mikroProg™ to
ST-LINK™ V2
adaper

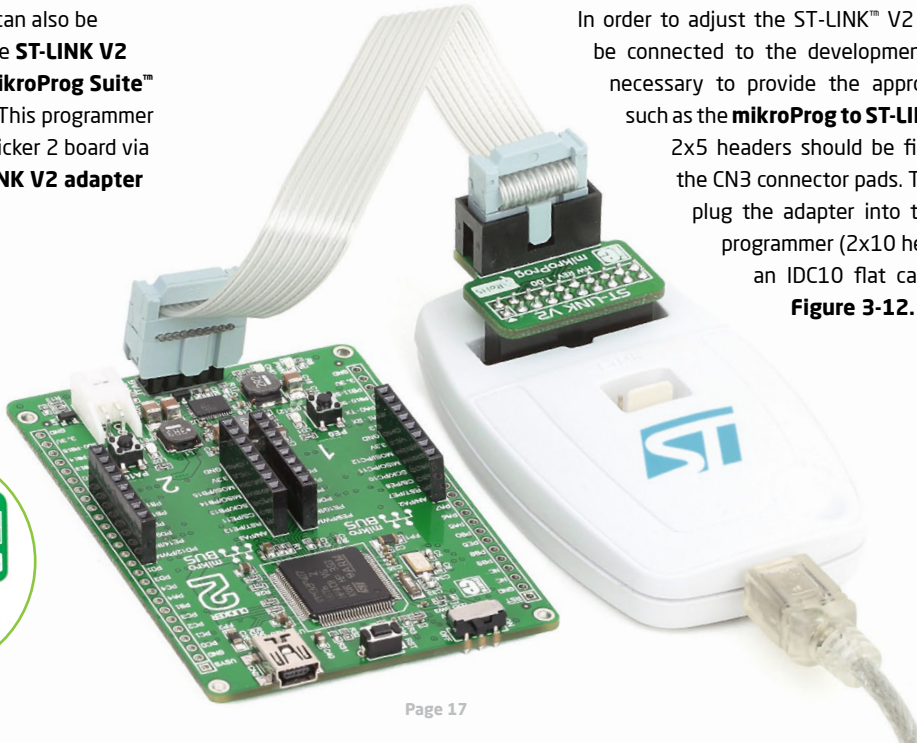

In order to adjust the ST-LINK™ V2 programmer to be connected to the development system, it is necessary to provide the appropriate adapter such as the **mikroProg to ST-LINK V2 adapter**. 2x5 headers should be first soldered on the CN3 connector pads. Then you should plug the adapter into the ST-LINK V2 programmer (2x10 header), and plug an IDC10 flat cable in headers, **Figure 3-12**.

Figure 3-12:
Connecting
ST-LINK™ V2
programmer

NOTE Before attaching the programming connector, you have to solder the provided 2x5 male header to the JTAG (CN3) pads.

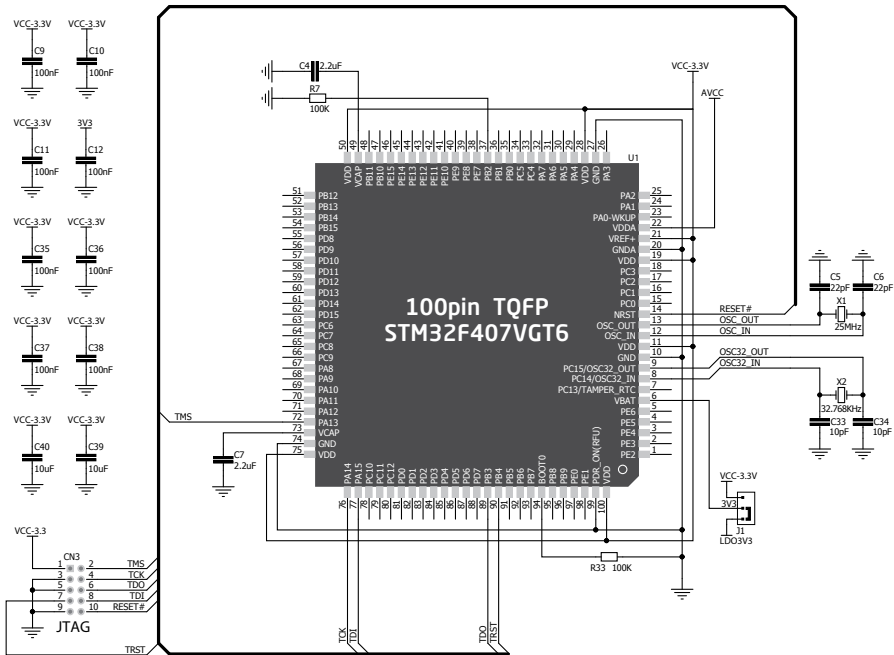

Figure 3-13: mikroProg™ connection schematic

4. Buttons and LEDs

The board also contains a **01 reset button** and a pair of **02 buttons** and **03 LEDs**, as well as an ON/OFF switch. The **Reset button** is used to manually reset the microcontroller—it generates a low voltage level on the microcontroller’s reset pin. **LEDs** can be used for visual indication of the logic state on two pins (**PE12** and **PE15**). An active LED indicates that a logic high (1) is present on the pin. Pressing any of the two **buttons** can change the logic state of the microcontroller pins (**PE0** and **PA10**) from logic high (1) to logic low (0). In addition to the onboard ON/OFF switch, two pads (EXT and PSW) allow you to connect your own external switch.

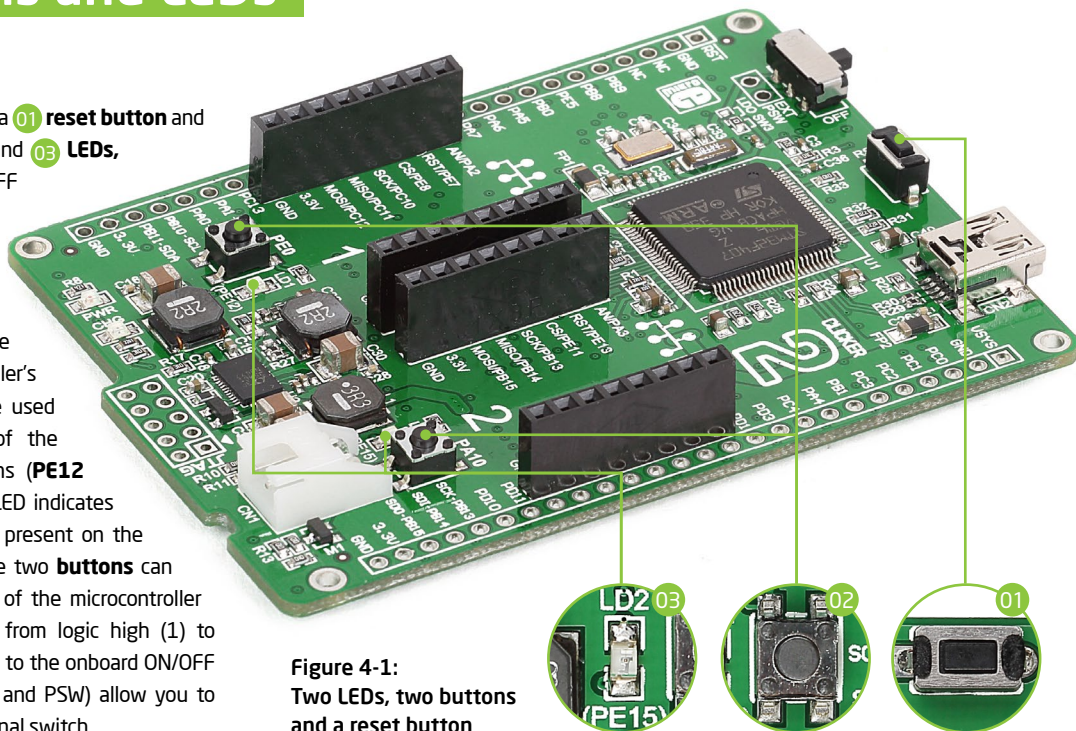

Figure 4-1:
Two LEDs, two buttons
and a reset button

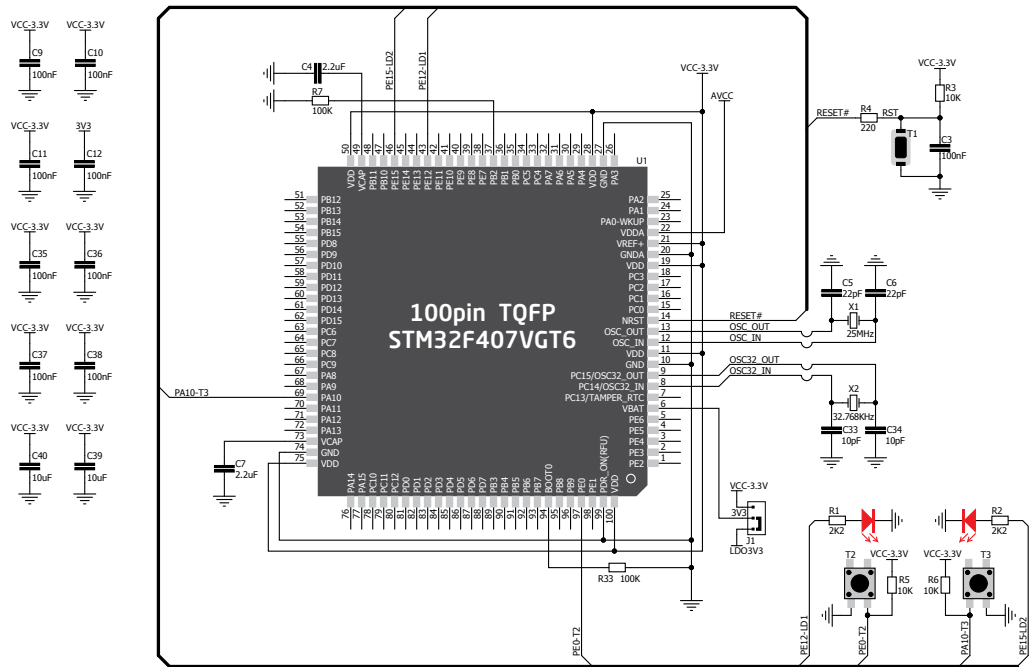

Figure 4-2: Other modules connection schematic

5. Power management and battery charger

clicker 2 for STM32 features **LTC®3586-2**, a highly integrated power management and battery charger IC that includes a current limited switching PowerPath manager. When you solder the onboard zero-ohm **J1** jumper to the LDO position (**Figure 6-1**), the LTC®3586-2 will provide an independent, steady power supply to the MCUs RTC from the li-polymer battery or USB, even when the rest of the system is turned off (or reset). LTC®3586 also **enables battery charging over a USB connection**.

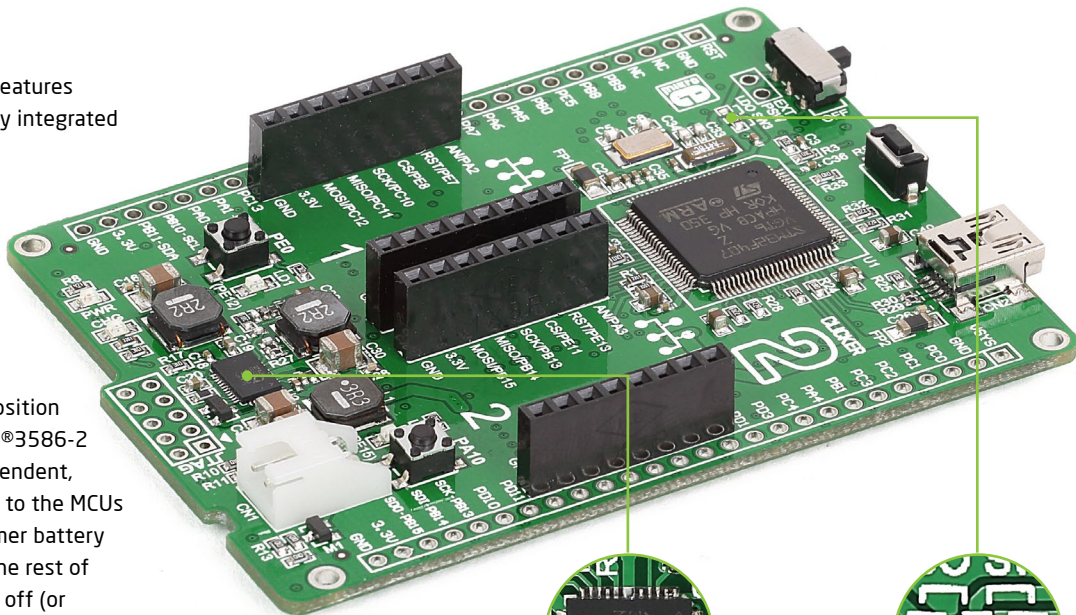

Figure 5-2: power management and battery charger IC



Figure 5-1: zero-ohm J1 jumper



6. Oscillators

The **STM32F407VGT6** microcontroller is equipped with an internal **16MHz RC oscillator** that provides a stable clock signal. Since the chips have an integrated PLL, this base frequency is suitable for further clock multiplication. Board also contains an additional **25MHz crystal oscillator**, as well as a **32.768kHz** one, which provides an external clock for the internal RTCC module.

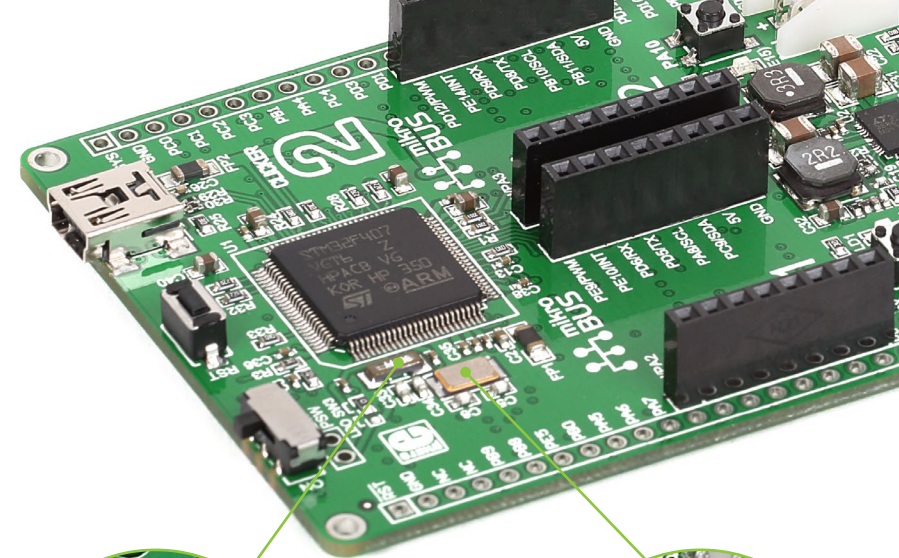
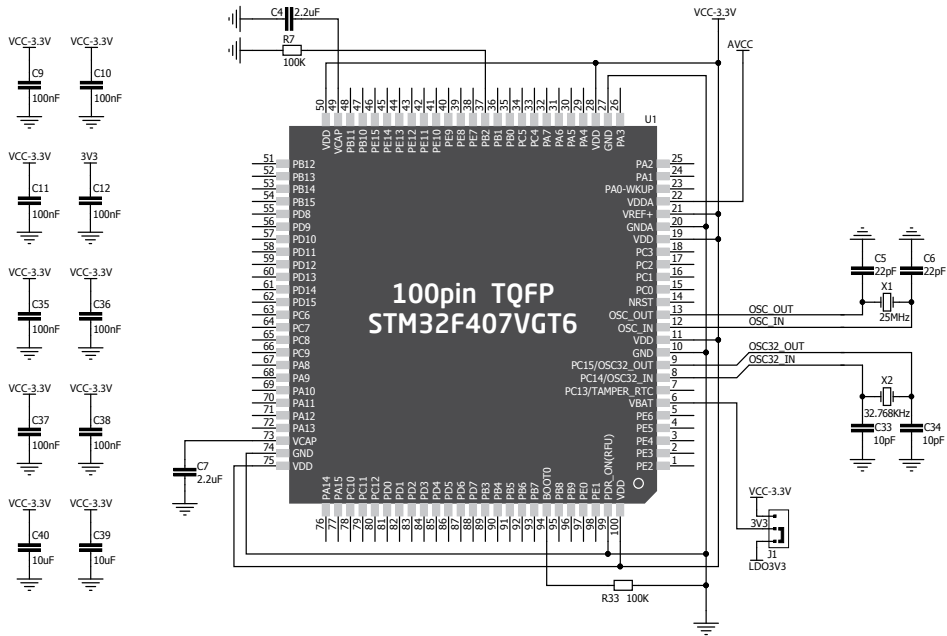

Figure 6-1:
32.768 kHz
crystal oscillator
module (X2)



Figure 6-2:
25MHz crystal
oscillator
module (X1)





NOTE | *The use of crystal in all other schematics is implied even if it is purposely left out, because of the schematics clarity.*

Figure 6-3:
Crystal oscillator schematic

7. USB connection

STM32F407VGT6 microcontrollers has an integrated USB module, which enables you to implement USB communication functionality to your clicker 2 board. Connection with target USB host is done over a Mini-B USB connector which is positioned next to the battery connector.

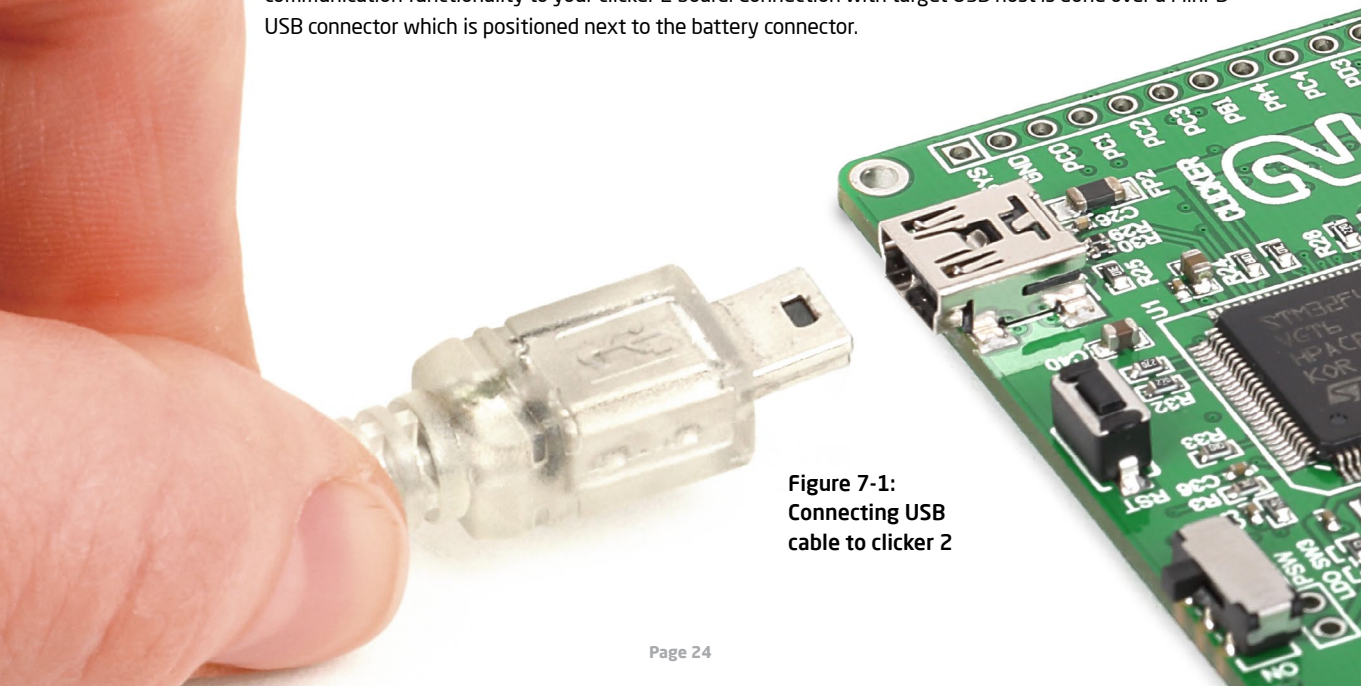

Figure 7-1:
Connecting USB
cable to clicker 2

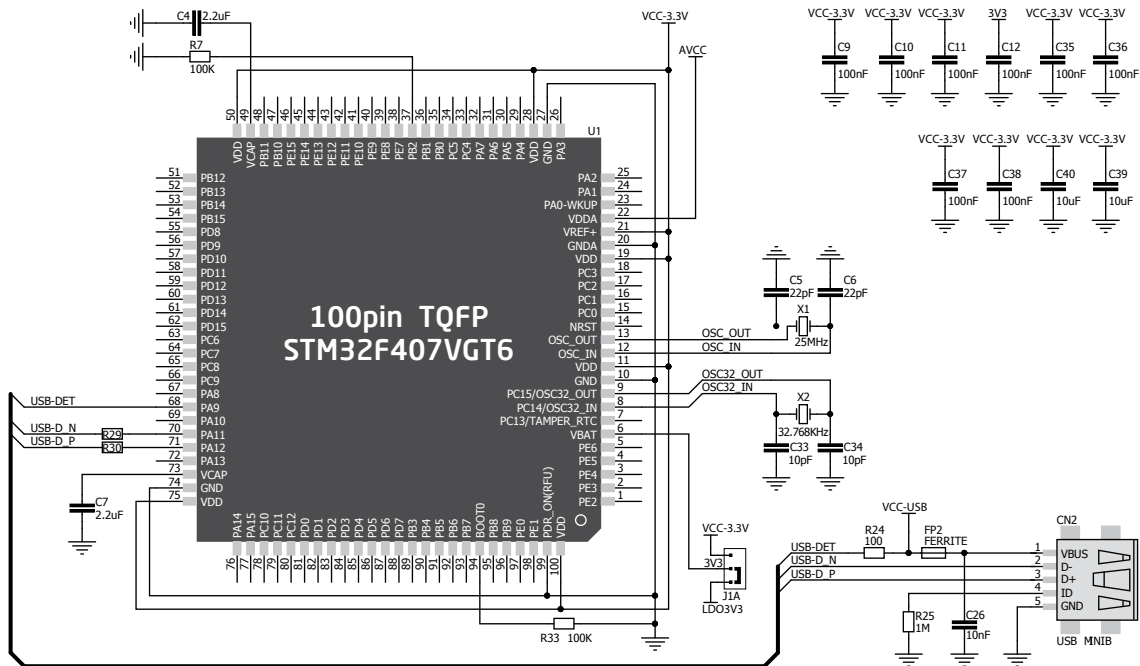
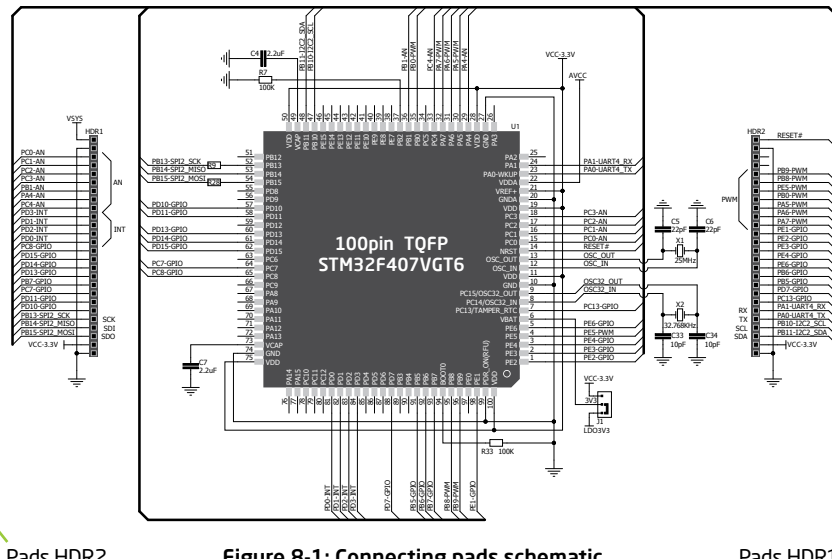

Figure 7-2: USB module connection schematic

8. Pads



Pads HDR2

Figure 8-1: Connecting pads schematic

Pads HDR1



Most microcontroller pins are available for further connectivity via two 1x26 rows of connection pads on both sides of the clicker 2 for STM32 board. They are designed to match additional shields, such as Battery Boost shield, Gaming, PROTO shield and others.

9. Pinout

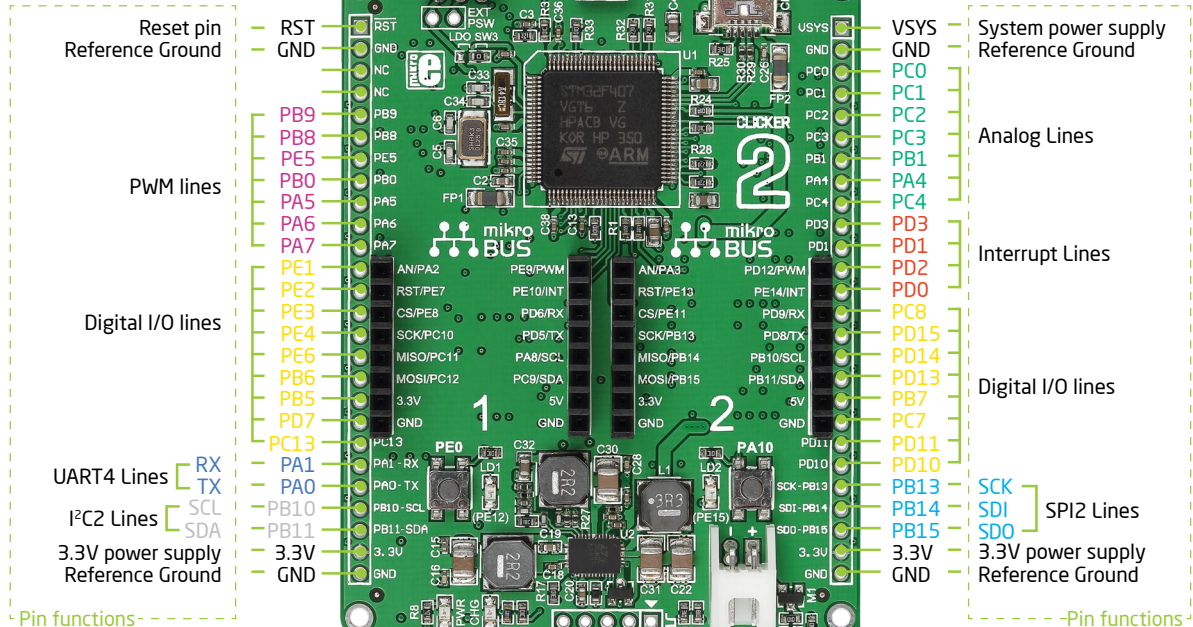

■ Digital lines ■ Analog Lines ■ Interrupt Lines ■ SPI Lines ■ I2C Lines ■ UART lines ■ PWM lines

9.1 mikroBUS™ pinouts

Having two mikroBUS™ sockets and an additional connection pad, clicker 2 for STM32 utilizes all of the STM32F407VGT6's I/Os. Each of the **three UART outputs** has its own separate connection pin (either on mikroBUS™ 1 or 2, or on the 2x26 connection pad). Of the **two SPI lines**, one is routed to mikroBUS™ 1; the other is shared between mikroBUS™ 2 and the pins on the connection pad. Same goes for the **two available I²C lines**.



Figure 9-1:
mikroBUS™
individual and
shared lines



10. click™ boards are plug and play!

Up to now, MikroElektronika has released more than 90 mikroBUS™ compatible **click™ boards**. On the average, one click board is released per week. It is our intention to provide you with as many add-on boards as possible, so you will be able to expand your development board with additional functionality. Each board comes with a set of working example code. Please visit the click™ boards webpage for the complete list of currently available boards:



www.mikroe.com/click

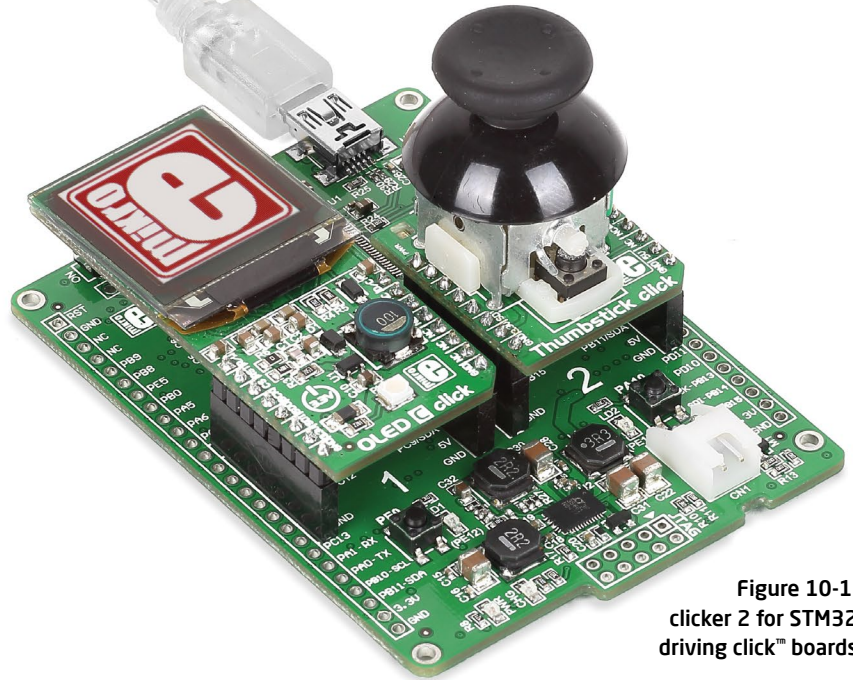
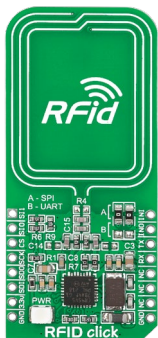
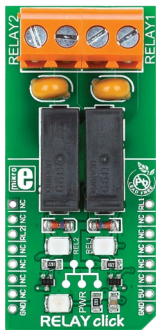

Figure 10-1:
clicker 2 for STM32
driving click™ boards



RFid click™



Relay click™

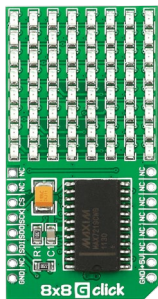

Bx8 click™

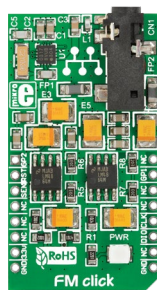

FM click™



Bluetooth2 click™

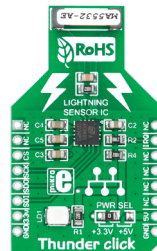

Thunder click™

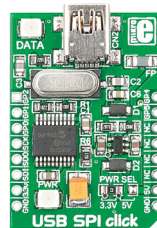

USB SPI click™

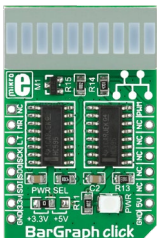

BarGraph click™

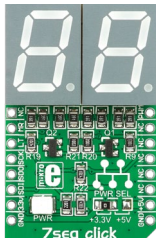

7seg click™



THERMO click™

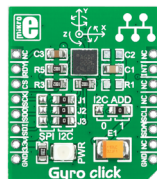

Gyro click™

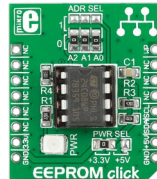

EEPROM click™

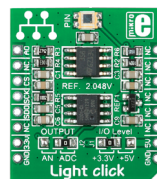

LightHz click™

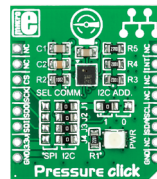

Pressure click™

11. Dimensions

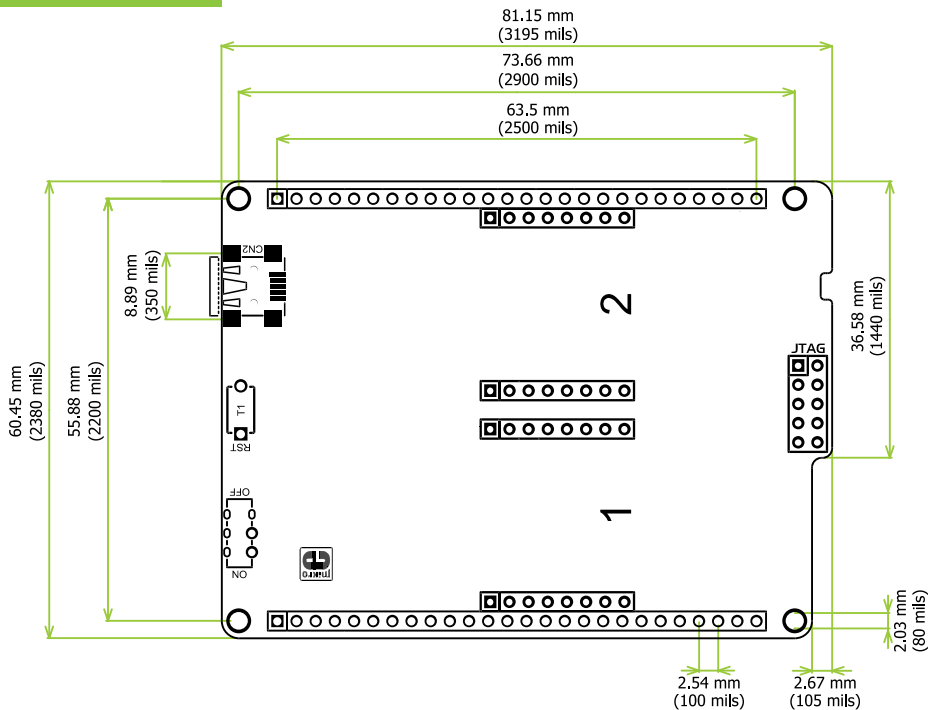

DISCLAIMER

All the products owned by MikroElektronika are protected by copyright law and international copyright treaty. Therefore, this manual is to be treated as any other copyright material. No part of this manual, including product and software described herein, may be reproduced, stored in a retrieval system, translated or transmitted in any form or by any means, without the prior written permission of MikroElektronika. The manual PDF edition can be printed for private or local use, but not for distribution. Any modification of this manual is prohibited.

MikroElektronika provides this manual 'as is' without warranty of any kind, either expressed or implied, including, but not limited to, the implied warranties or conditions of merchantability or fitness for a particular purpose.

MikroElektronika shall assume no responsibility or liability for any errors, omissions and inaccuracies that may appear in this manual. In no event shall MikroElektronika, its directors, officers, employees or distributors be liable for any indirect, specific, incidental or consequential damages (including damages for loss of business profits and business information, business interruption or any other pecuniary loss) arising out of the use of this manual or product, even if MikroElektronika has been advised of the possibility of such damages. MikroElektronika reserves the right to change information contained in this manual at any time without prior notice, if necessary.

HIGH RISK ACTIVITIES

The products of MikroElektronika are not fault - tolerant nor designed, manufactured or intended for use or resale as on - line control equipment in hazardous environments requiring fail - safe performance, such as in the operation of nuclear facilities, aircraft navigation or communication systems, air traffic control, direct life support machines or weapons systems in which the failure of Software could lead directly to death, personal injury or severe physical or environmental damage ('High Risk Activities'). MikroElektronika and its suppliers specifically disclaim any expressed or implied warranty of fitness for High Risk Activities.

TRADEMARKS

The MikroElektronika name and logo, mikroC™, mikroBasic™, mikroPascal™, Visual TFT™, Visual GLCD™, mikroProg™, Ready™, MINI™, mikroBUS™, EasyPIC™, EasyAVR™, Easy8051™, click™ boards and mikromedia™ are trademarks of MikroElektronika. All other trademarks mentioned herein are property of their respective companies. All other product and corporate names appearing in this manual may or may not be registered trademarks or copyrights of their respective companies, and are only used for identification or explanation and to the owners' benefit, with no intent to infringe.

Copyright © 2014 MikroElektronika. All Rights Reserved.



If you want to learn more about our products, please visit our web site at www.mikroe.com

If you are experiencing some problems with any of our products or just need additional information, please place your ticket at www.mikroe.com/support

If you have any questions, comments or business proposals,
do not hesitate to contact us at office@mikroe.com

clicker 2 for STM32 manual
ver. 1.00

