

STRADELLA-IP-28-T2-PC

IESNA Type II (medium) beam, applicable for European P-class standard pedestrian lighting and M-class roads. Variant made from PC.

TECHNICAL SPECIFICATIONS:

Dimensions	100.0 mm
Height	9.2 mm
Fastening	screw
ROHS compliant	yes ⓘ

MATERIAL SPECIFICATIONS:

Component	Type	Material	Colour	Finish
STRADELLA-IP-28-T2-PC	Multi-lens	PC	clear	
STRADELLA-28-SEAL	Seal	Silicone	white	





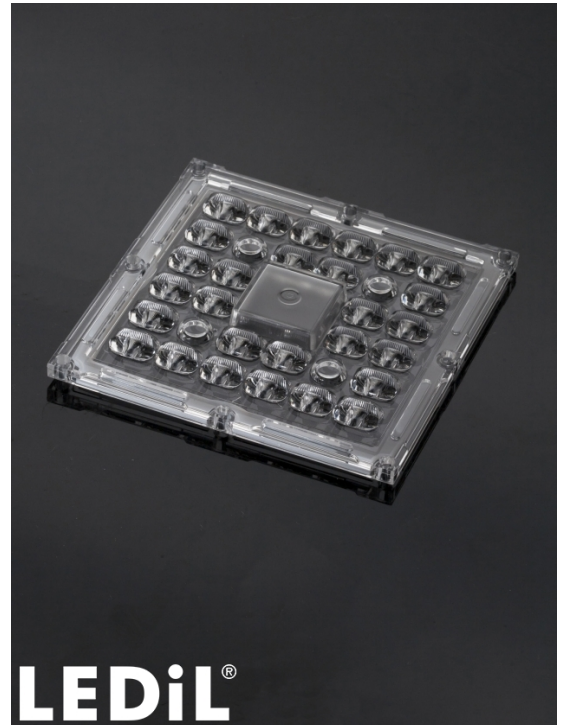

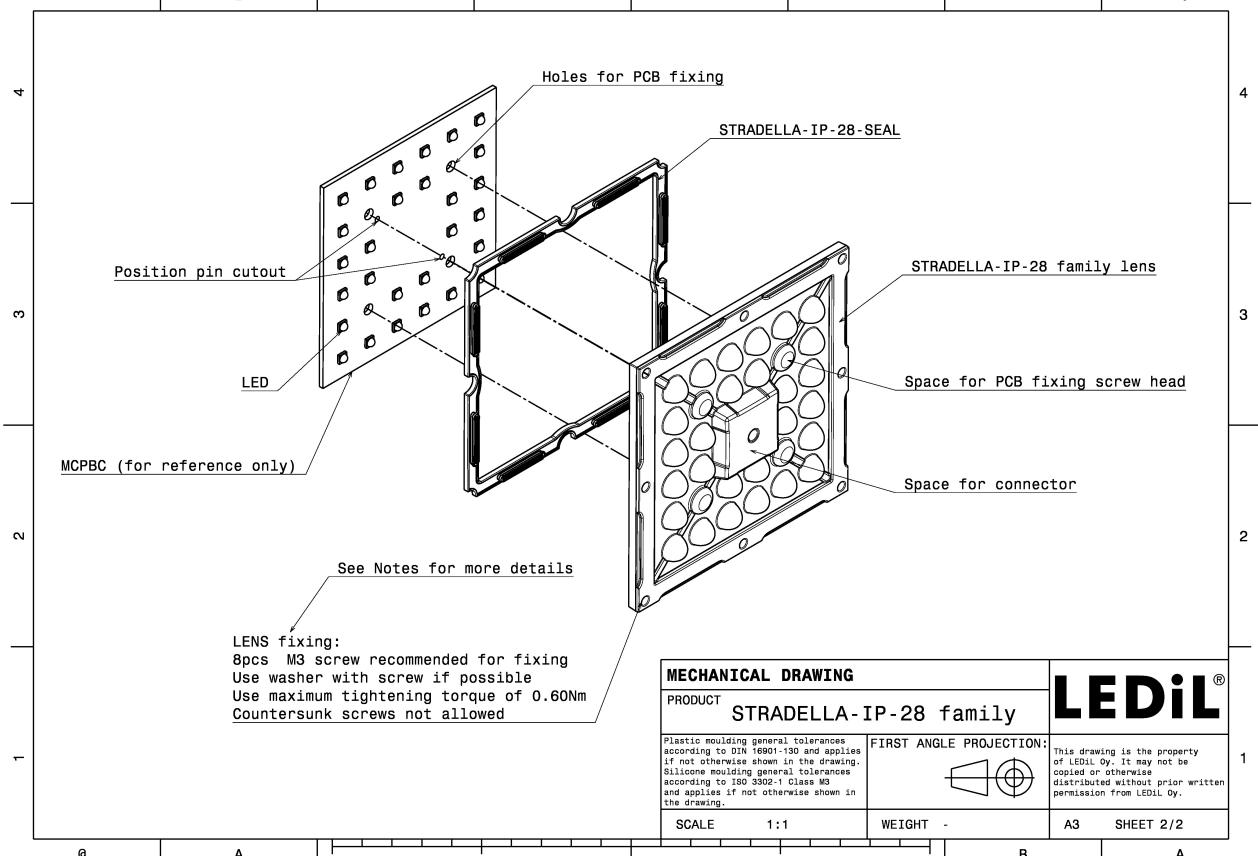
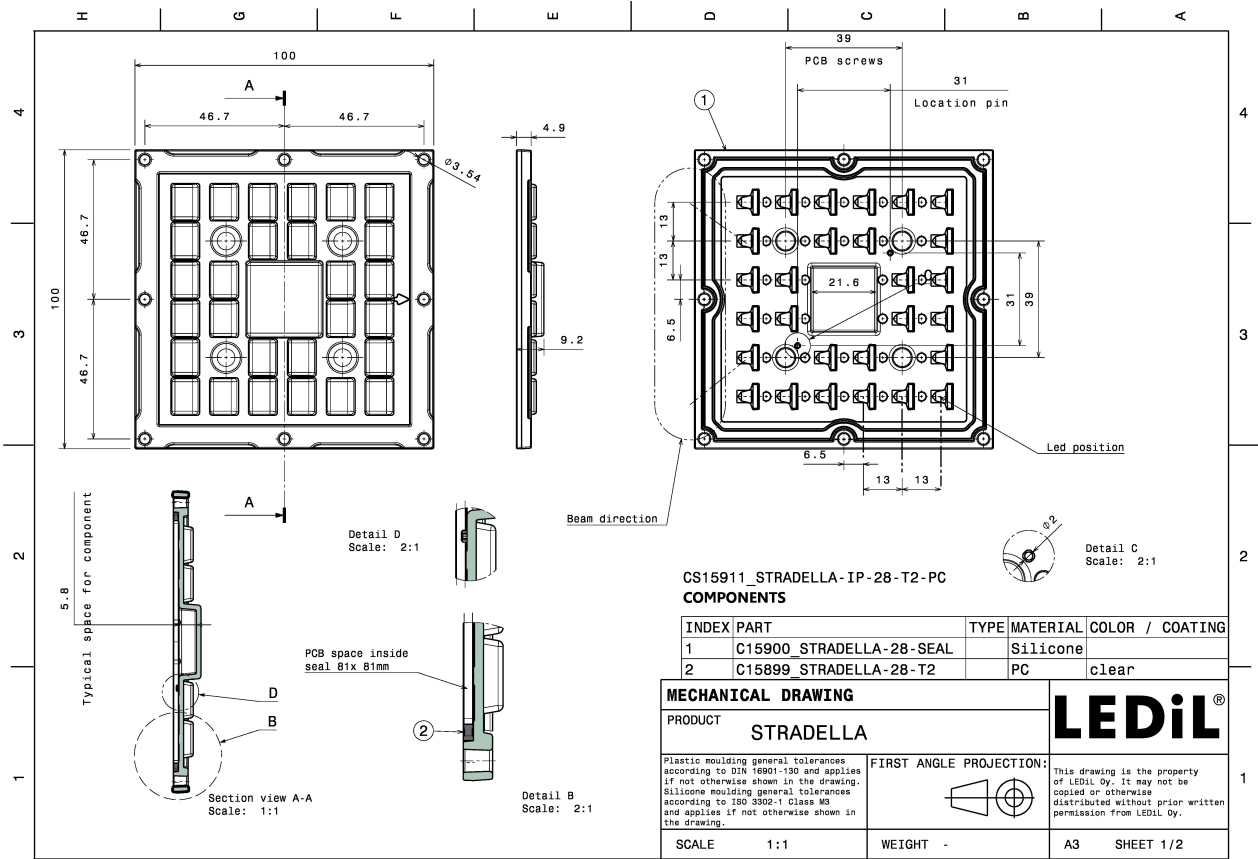
ORDERING INFORMATION:

Component		Qty in box	MOQ	MPQ	Box weight (kg)
CS15911_STRADELLA-IP-28-T2-PC	Multi-lens	156	78	78	6.1
» Box size: 476 x 273 x 247 mm					

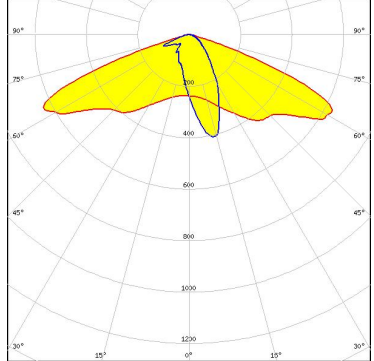

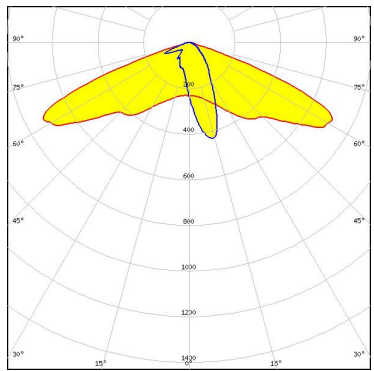

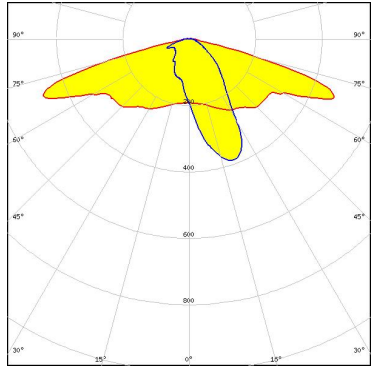
PHOTOMETRIC DATA (MEASURED):

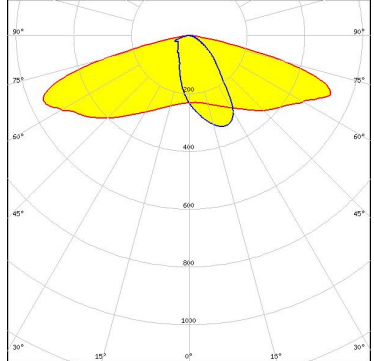
 <p> LED HiQLED STR28 CR JE2835 4x7 xxx FWHM Asymmetric Efficiency 90 % Peak intensity 1 cd/lm LEDs/each optic 1 Light colour White Required components: </p>	
 <p> LED HiQLED STR28 CR JÐ§3030 4x7 xxx FWHM Asymmetric Efficiency 90 % Peak intensity 1.1 cd/lm LEDs/each optic 1 Light colour White Required components: </p>	
 <p> LED QUICK FLUX STR28 XD2x14 xxx G8 FWHM Asymmetric Efficiency 90 % Peak intensity 0.9 cd/lm LEDs/each optic 1 Light colour White Required components: </p>	
 <p> LED QUICK FLUX STR28 XP2x14 xxx G7 FWHM Asymmetric Efficiency 91 % Peak intensity 0.6 cd/lm LEDs/each optic 1 Light colour White Required components: </p>	

PHOTOMETRIC DATA (MEASURED):



LED QUICK FLUX STR28 XT2x14 xxx G5
FWHM Asymmetric
Efficiency 91 %
Peak intensity 0.6 cd/lm
LEDs/each optic 1
Light colour White
Required components:

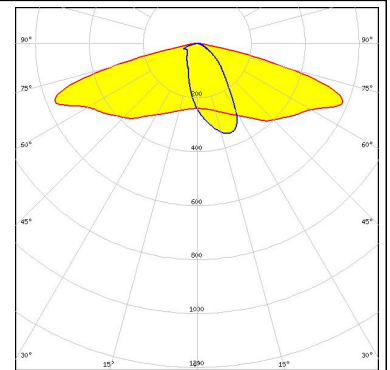

LED J Series 2835
FWHM Asymmetric
Efficiency 90 %
Peak intensity 1 cd/lm
LEDs/each optic 1
Light colour White
Required components:

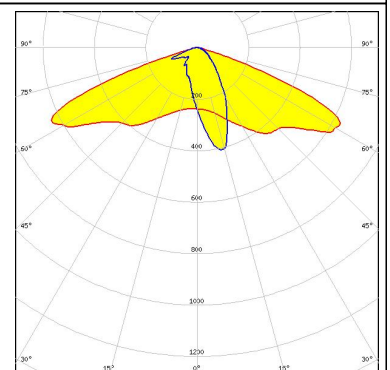

LED J Series 3030
FWHM Asymmetric
Efficiency 90 %
Peak intensity 1.1 cd/lm
LEDs/each optic 1
Light colour White
Required components:

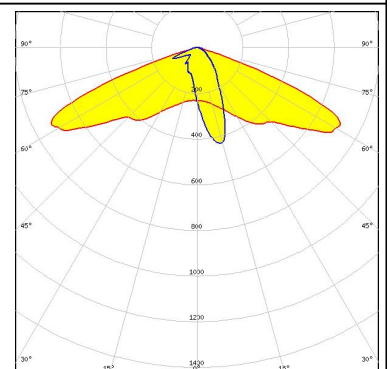

LED XD16
FWHM Asymmetric
Efficiency 90 %
Peak intensity 0.9 cd/lm
LEDs/each optic 1
Light colour White
Required components:

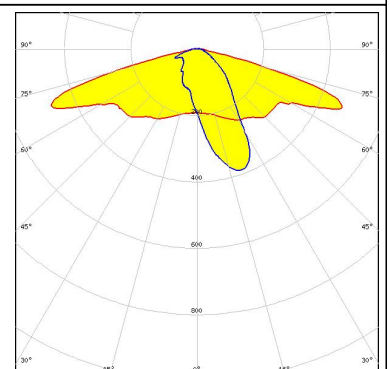

PHOTOMETRIC DATA (MEASURED):

CREE

LED XP-G3
 FWHM Asymmetric
 Efficiency 91 %
 Peak intensity 0.6 cd/lm
 LEDs/each optic 1
 Light colour White
 Required components:

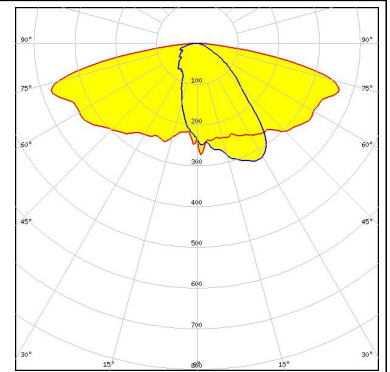

CREE

LED XT-E
 FWHM Asymmetric
 Efficiency 91 %
 Peak intensity 0.6 cd/lm
 LEDs/each optic 1
 Light colour White
 Required components:

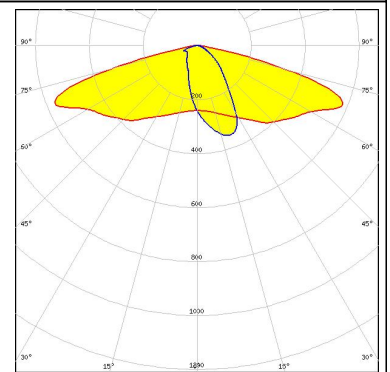

LUMILEDS

LED LUXEON 3030 2D (Round LES)
 FWHM Asymmetric
 Efficiency 91 %
 Peak intensity 0.9 cd/lm
 LEDs/each optic 1
 Light colour White
 Required components:

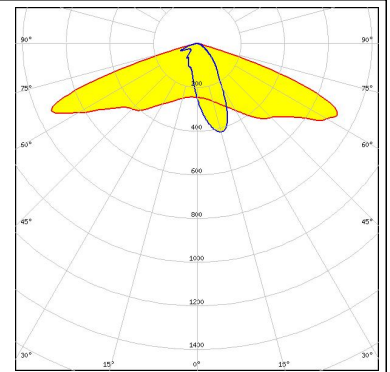

NICHIA

LED NF2x757G
 FWHM Asymmetric
 Efficiency 91 %
 Peak intensity 0.7 cd/lm
 LEDs/each optic 1
 Light colour White
 Required components:

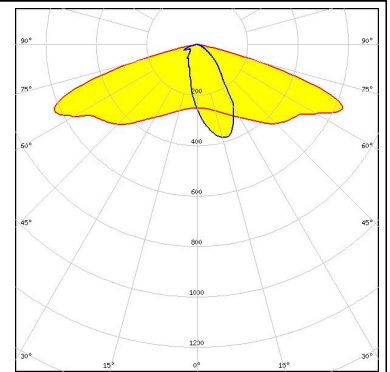

PHOTOMETRIC DATA (MEASURED):

OSRAM

Opto Semiconductors

LED Duris S5 (2 chip)
 FWHM Asymmetric
 Efficiency 92 %
 Peak intensity 0.8 cd/lm
 LEDs/each optic 1
 Light colour White
 Required components:

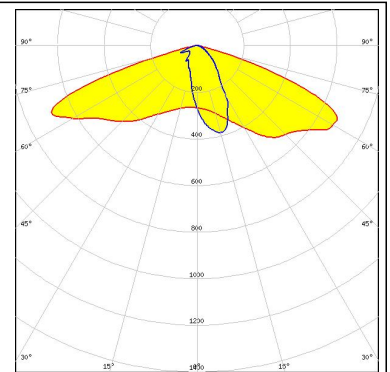

OSRAM

Opto Semiconductors

LED OSCONIQ S 3030
 FWHM Asymmetric
 Efficiency 92 %
 Peak intensity 0.7 cd/lm
 LEDs/each optic 1
 Light colour White
 Required components:

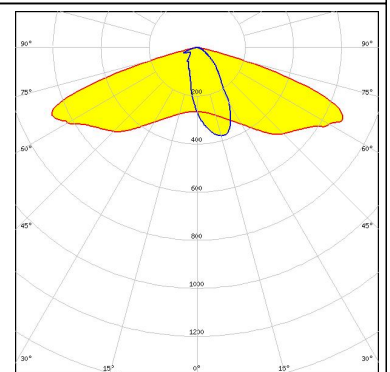

OSRAM

Opto Semiconductors

LED OSLON Square CSSRM2/CSSRM3
 FWHM Asymmetric
 Efficiency 92 %
 Peak intensity 0.8 cd/lm
 LEDs/each optic 1
 Light colour White
 Required components:

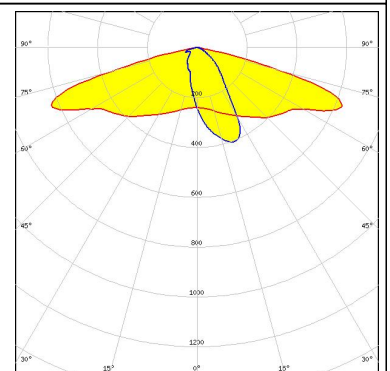

SAMSUNG

LED HiLOM SC28 (LH181B)
 FWHM Asymmetric
 Efficiency 89 %
 Peak intensity 0.9 cd/lm
 LEDs/each optic 1
 Light colour White
 Required components:

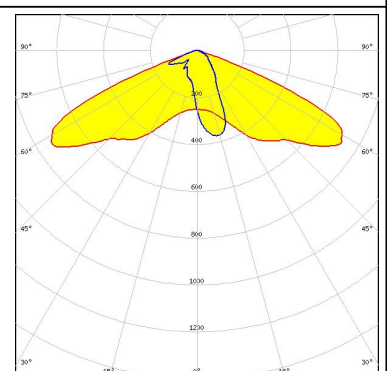

PHOTOMETRIC DATA (MEASURED):

SAMSUNG

LED HiLOM SM28 (LM301B)
FWHM Asymmetric
Efficiency 90 %
Peak intensity 0.9 cd/lm
LEDs/each optic 1
Light colour White
Required components:

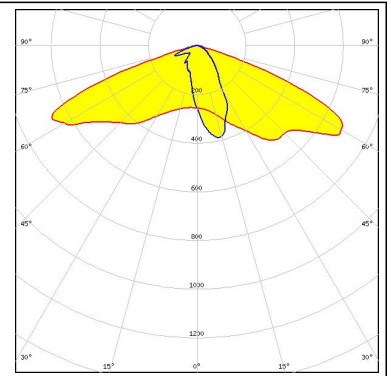

PHOTOMETRIC DATA (SIMULATED):



LED NF2x757G
FWHM Asymmetric
Efficiency 91 %
Peak intensity 0.7 cd/lm
LEDs/each optic 1
Light colour White
Required components:

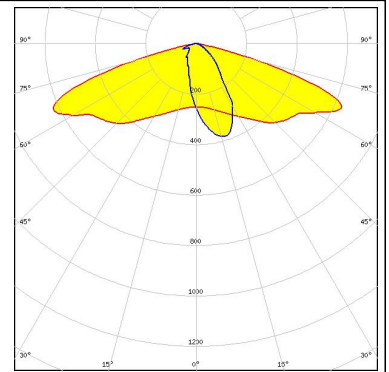

LED NVSW319B
FWHM Asymmetric
Efficiency 84 %
Peak intensity 0.4 cd/lm
LEDs/each optic 1
Light colour White
Required components:

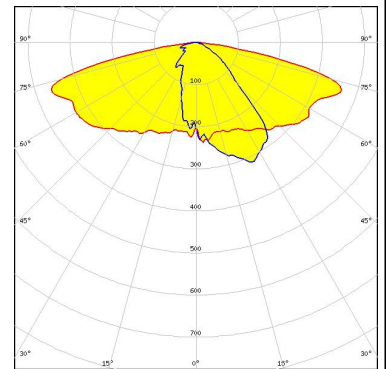

LED NVSxx19B/NVSxx19C
FWHM Asymmetric
Efficiency 87 %
Peak intensity 0.5 cd/lm
LEDs/each optic 1
Light colour White
Required components:

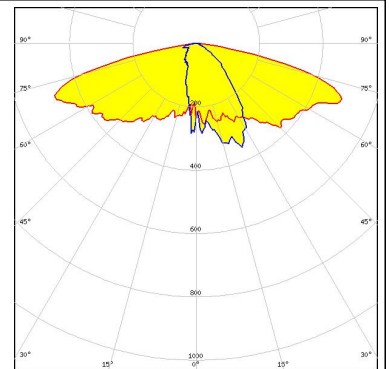

LED OSCONIQ P 3030
FWHM Asymmetric
Efficiency 94 %
Peak intensity 0.7 cd/lm
LEDs/each optic 1
Light colour White
Required components:

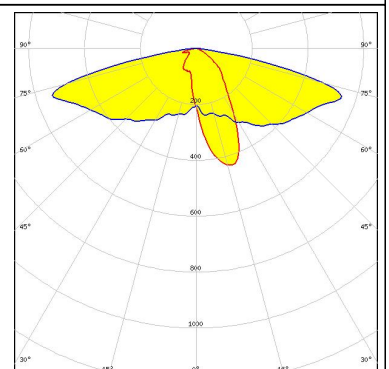

PHOTOMETRIC DATA (SIMULATED):

OSRAM

Opto Semiconductors

LED OSLON Square CSSRM2/CSSRM3
FWHM Asymmetric
Efficiency 93 %
Peak intensity 0.6 cd/lm
LEDs/each optic 1
Light colour White
Required components:

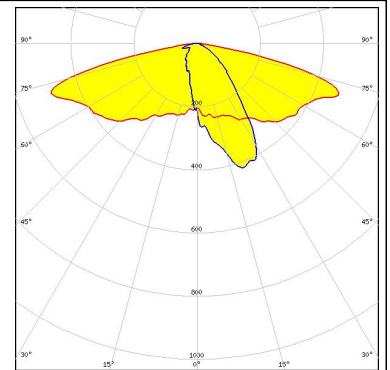

SAMSUNG

LED LH231B
FWHM Asymmetric
Efficiency 88 %
Peak intensity 0.6 cd/lm
LEDs/each optic 1
Light colour White
Required components:

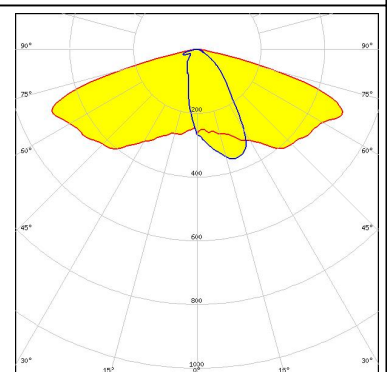

SAMSUNG



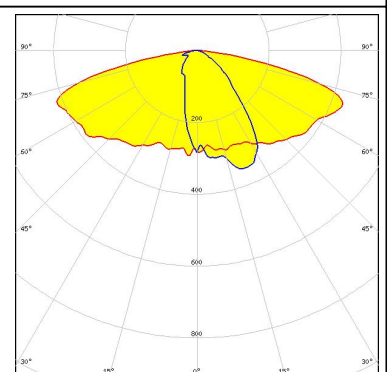

LED LH351B
FWHM Asymmetric
Efficiency 92 %
Peak intensity 0.5 cd/lm
LEDs/each optic 1
Light colour White
Required components:

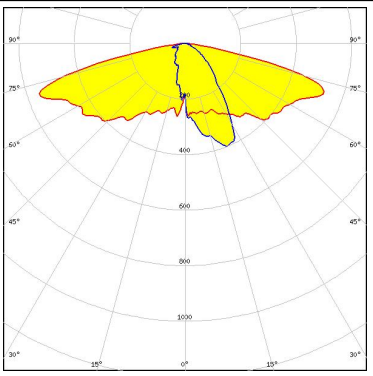

SEOUL SEMICONDUCTOR

LED SEOUL DC 3030
FWHM Asymmetric
Efficiency 90 %
Peak intensity 0.6 cd/lm
LEDs/each optic 1
Light colour White
Required components:

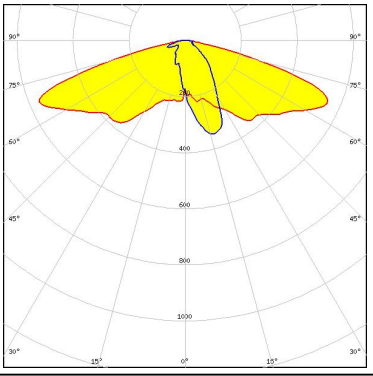
PHOTOMETRIC DATA (SIMULATED):

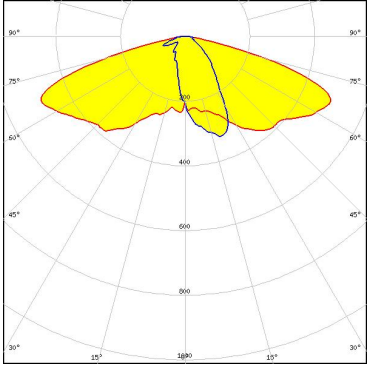
<p> SEUL SEMICONDUCTOR</p> <p>LED: Z5M1/Z5M2 FWHM: Asymmetric Efficiency: 89 % Peak intensity: 0.6 cd/lm LEDs/each optic: 1 Light colour: White Required components:</p>	
<p> SEUL SEMICONDUCTOR</p> <p>LED: Z8Y19 FWHM: Asymmetric Efficiency: 85 % Peak intensity: 0.7 cd/lm LEDs/each optic: 1 Light colour: White Required components:</p>	
<p> SEUL SEMICONDUCTOR</p> <p>LED: Z8Y22 FWHM: Asymmetric Efficiency: 85 % Peak intensity: 0.6 cd/lm LEDs/each optic: 1 Light colour: White Required components:</p>	

GENERAL INFORMATION:

NOTE: The typical beam angle will be changed by different color, chip size and chip position tolerance. The typical total beam angle is the full angle measured where the luminous intensity is half of the peak value.

MATERIALS:

As part of our continuous research and improvement processes, and to ensure the best possible quality and availability of our products, LEDiL reserves the right to change material grades without notice.

PRODUCT DATA USER AGREEMENT AND DISCLAIMER:

The measured data in the provided downloadable LEDiL Product Datasheets and Mechanical 2D-Drawings is rounded and provided as reference for planning. LEDiL Oy's optical specifications have been verified by conducting performance testing of the products in accordance with the company's quality system. The reported data are averaged results of multiple measurements with typical variation. LEDiL Oy reserves the right to without prior notification make changes and improvements to its products.

LEDiL Oy assumes neither warranty, nor guarantee nor any other liability of any kind for the contents and correctness of the provided data. The provided data has been generated with highest diligence but the provided data may in reality not represent the complete possible variation range of all intrinsic parameters. Therefore, in certain cases a deviation from the provided data could occur.

LEDiL Oy reserves the right to undertake technical changes of its products without further notification which could lead to changes in the provided data. LEDiL Oy assumes no liability of any kind for the possible deviation from any provided data or any other damage resulting from the usage of the provided data.

The user agrees to this disclaimer and user agreement with the download or usage of the provided files.

LEDiL Oy

Joensuunkatu 13
FI-24240 SALO
Finland

LEDiL Inc.

228 West Page Street
Suite D
Sycamore IL 60178
USA

Local sales and technical support

[www.ledil.com/
where_to_buy](http://www.ledil.com/where_to_buy)

Shipping locations

Salo, Finland
Hong Kong, China

Distribution Partners

[www.ledil.com/
where_to_buy](http://www.ledil.com/where_to_buy)