

Product Description

The Qorvo TGP2108-SM is a packaged 6-bit digital phase shifter fabricated on Qorvo's high performance 0.15 μm GaAs pHEMT process. It operates over 2.5-4 GHz while providing 360 of phase coverage with a LSB of 5.625. The TGP2108-SM offers an exceptional RMS phase error of $<2^\circ$ and amplitude error of <0.4 dB over most of the operational band. With other equally impressive small signal and linearity characteristics, the TGP2108-SM delivers superior performance for your S-band phased array applications.

Housed in a small 5 x 5 mm plastic overmold QFN package, DC blocked on both ports with bi-directional operation and the use of positive only control logic, the TGP2108-SM supports ease of use and simply system integration. Low DC power consumption also provides the system designer more flexibility in the overall power management of the system.

The device is lead-free and RoHS compliant.

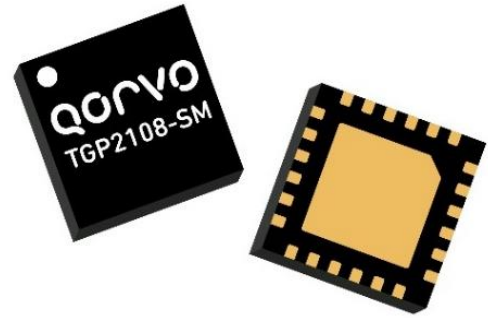

Product Features

- Frequency Range: 2.5 to 4 GHz
- 6-Bit Digital Phase Shifter
- Bi-Directional
- 360° Coverage, LSB = 5.625°
- RMS Phase Error: $< 2^\circ$ (2.7 – 3.7 GHz)
 $< 5^\circ$ (other frequencies)
- RMS Amplitude Error: < 0.4 dB
- Insertion Loss: 5 dB
- Return Loss: 15 dB
- Input P1dB: 29 dBm
- Input IP3: 45 dBm
- Control Voltage: 0 /+3V to +5 V
- QFN Package Dimensions: 5.0 x 5.0 x 0.85 mm

Performance is typical across frequency. Please reference electrical specification table and data plots for more details.

Block Diagram

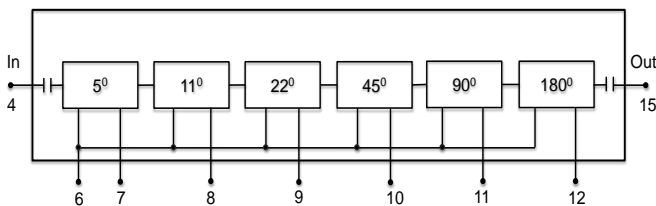

Applications

- S-Band Radar

Ordering Information

Part No.	Description
TGP2108-SM	2.5-4GHz 6-Bit Digital Phase Shifter
TGP2108-SM EVB	TGP2108-SM Evaluation Board



TGP2108-SM

2.5-4GHz 6-Bit Digital Phase Shifter

Electrical Specifications

Test conditions unless otherwise noted: 25°C. Control Voltage (REF, 5°, 11°, 22°, 45°, 90°, 180°) = 0/+5 V; See Bias Truth Table.

Parameter	Phase	Freq. (GHz)	Min	Typical	Max	Units
Operational Frequency Range			2.5		4	GHz
Insertion Loss	5°			5	7.5	dB
	355°				8.5	
Input Return Loss				15		dB
Output Return Loss				15		dB
RMS Phase Error		2.7 – 3.7		< 2		deg
		Others		< 5		
RMS Amplitude Error				< 0.4		dB
Relative Phase	5°	2.5, 3.5, 4	5	6	8	degree
		3	4	5	7	
	11°	2.5	12	13	16	
		3	11	12	14	
		3.5, 4	11	12	15	
	22°	2.5, 3	20	22	26	
		3.5	21	24	28	
		4	22	25	29	
	45°	2.5	43	46	52	
		3	41	44	48	
		3.5	42	45	49	
		4	44	46	50	
	90°	2.5	88	92	99	
		3	84	88	95	
		3.5	85	89	96	
		4	88	91	98	
	180°	2.5	178	184	196	
		3	172	177	189	
		3.5	175	180	192	
		4	184	188	200	
	355°	2.5	355	6	26	
		3	342	355	13	
		3.5	346	356	16	
		4	358	10	30	
Input P1dB				29		dBm
Input IP3 (Spacing = 10 MHz, Pin/Tone = 8 dBm)				45		dBm
Insertion Loss Temperature Coefficient				0.002		dB/°C



TGP2108-SM

2.5-4GHz 6-Bit Digital Phase Shifter

Absolute Maximum Rating

Parameter	Value
Control and Reference Voltage	6 V
Control Current	1 mA
Power Dissipation	1.5 W
Input Power, CW, 50 Ω , 85°C	33 dBm
Channel Temperature	200 °C
Mounting Temperature (30 Seconds)	260 °C
Storage Temperature	-55 to 150 °C

Operation of this device outside the parameter ranges given above may cause permanent damage. These are stress ratings only, and functional operation of the device at these conditions is not implied. Extended application of Absolute Maximum Rating conditions may reduce device reliability.

Recommended Operating Conditions

Parameter	Value
Control Voltage	0/+5 V
Reference Voltage (V_{REF})	+5 V
Current (I_{REF} , I_{CTRL})	< 0.3 mA
Supply Current (I_S)	100 μ A typical
Temperature Range	-40 to +85 °C

Electrical specifications are measured at specified test conditions. Specifications are not guaranteed overall operating conditions.

Bias Truth Table

Logic "0" = 0 V, Logic "1" = V_{REF} = +3V or +5 V

Phase Shifter	5°	11°	22°	45°	90°	180°	REF
0° (Reference)	0	0	0	0	0	0	1
5°	1	0	0	0	0	0	1
11°	0	1	0	0	0	0	1
22°	0	0	1	0	0	0	1
45°	0	0	0	1	0	0	1
90°	0	0	0	0	1	0	1
180°	0	0	0	0	0	1	1
355°	1	1	1	1	1	1	1

Performance Plots – Small Signal

Test conditions unless otherwise noted: 5V and 3V, 25 °C

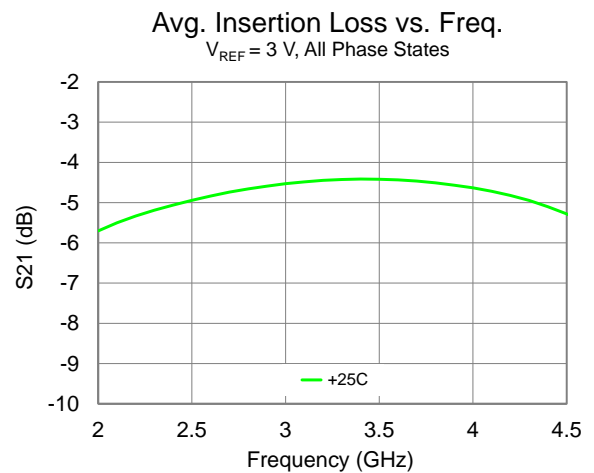
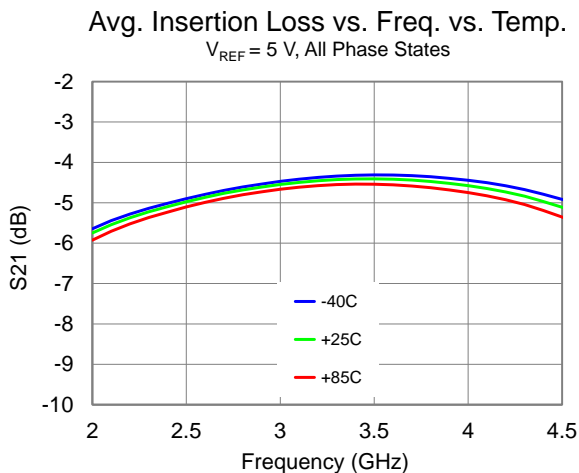
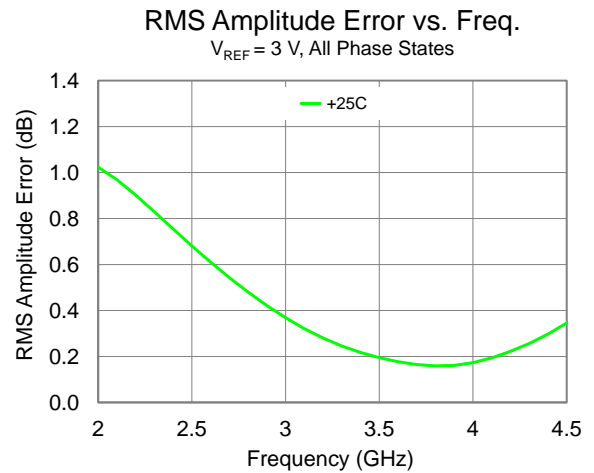
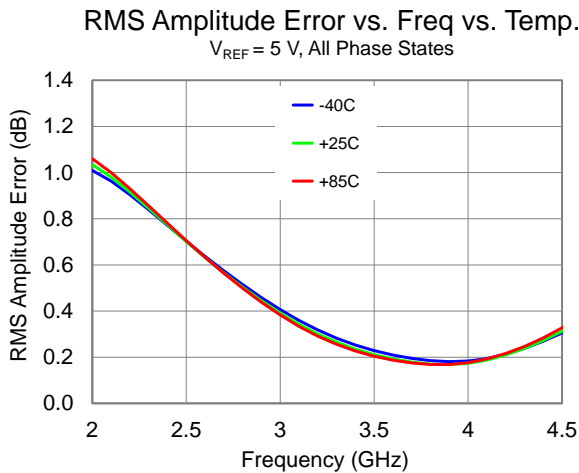
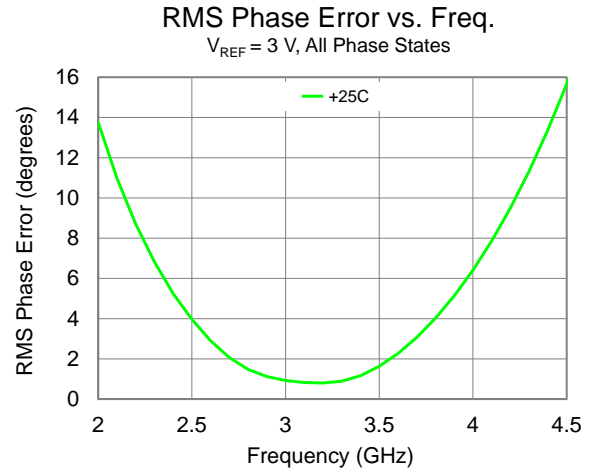
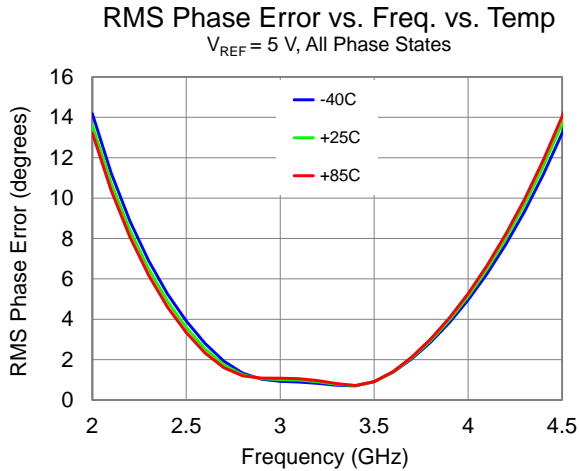

Performance Plots – Small Signal (Cont.)

Test conditions unless otherwise noted: 5V and 3V, 25 °C

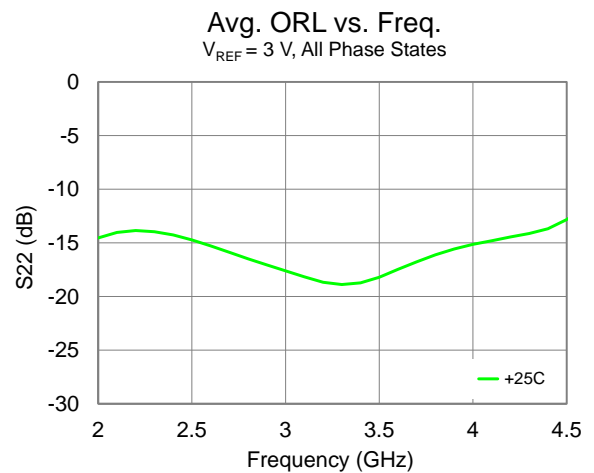
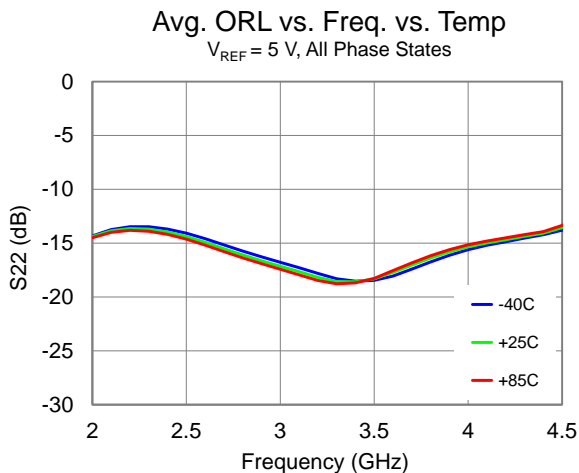
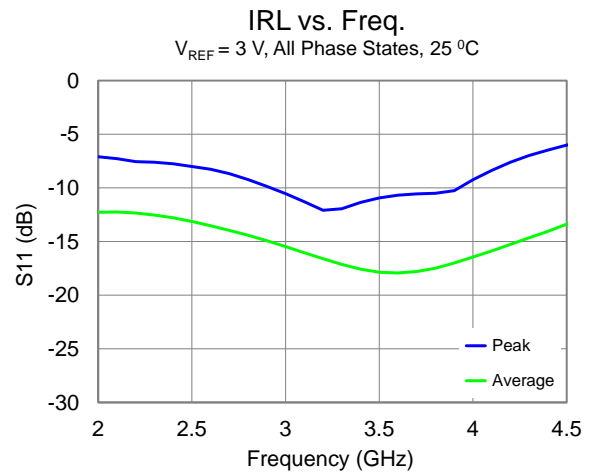
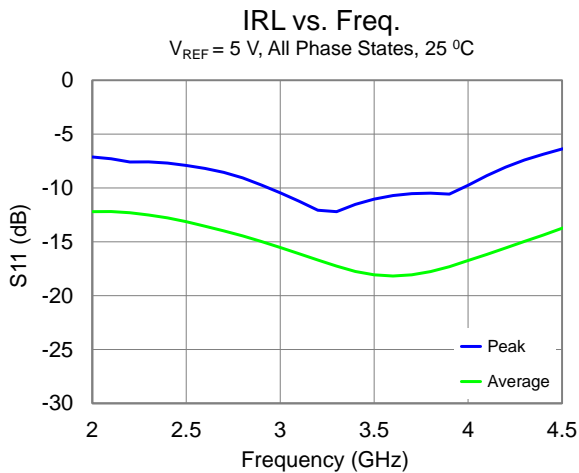
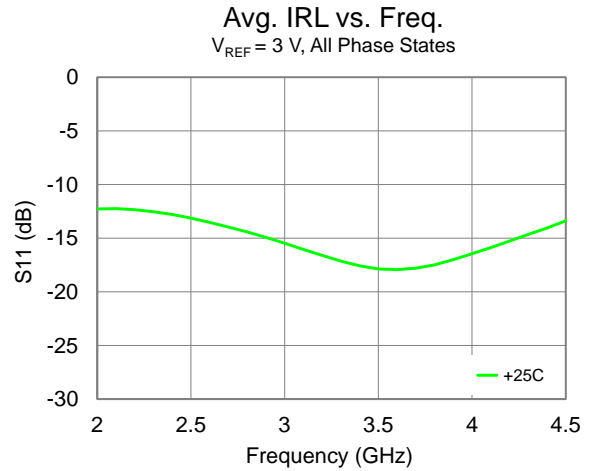
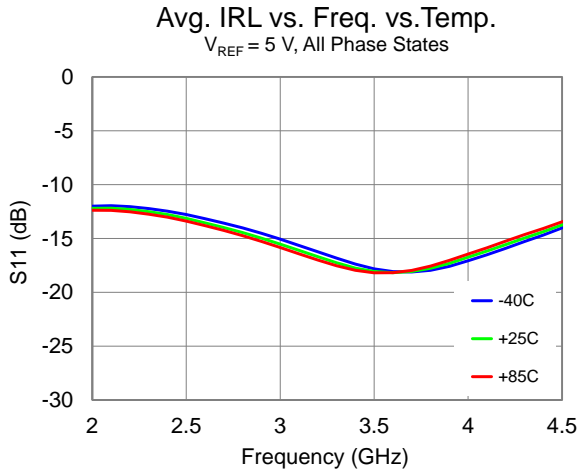

Performance Plots – Small Signal (Cont.)

Test conditions unless otherwise noted: 5V and 3V, 25 °C

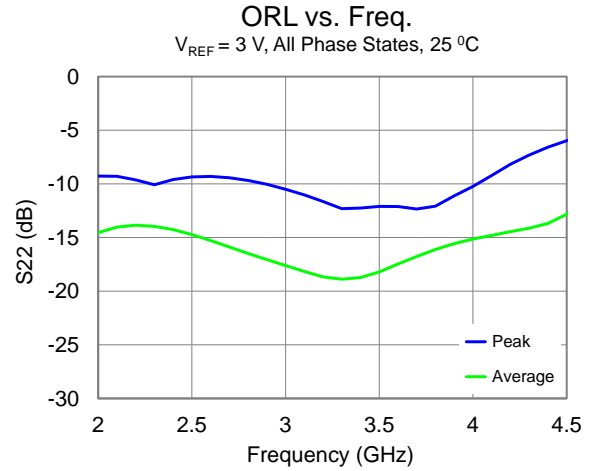
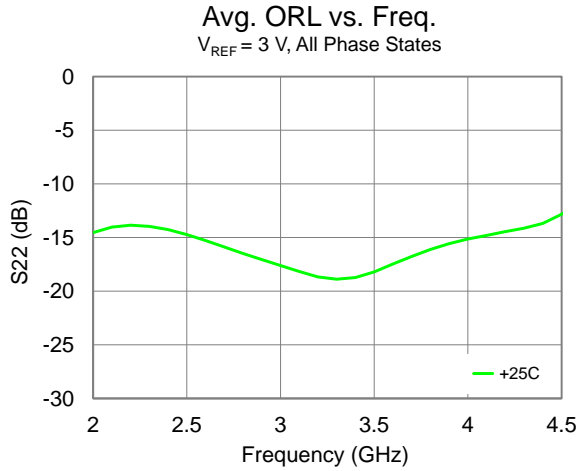

Performance Plots – Large Signal

Test conditions unless otherwise noted: 5V and 3V, 25 °C

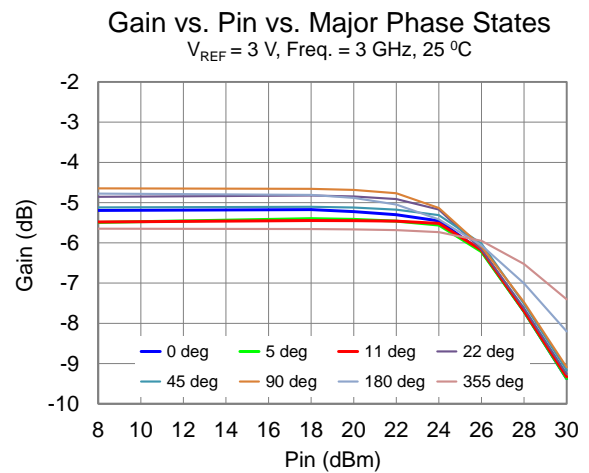
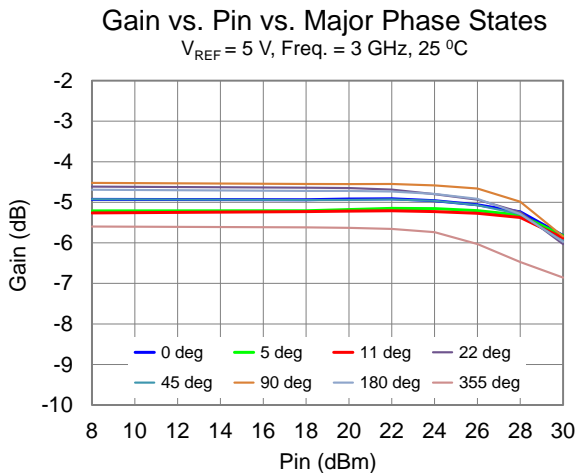
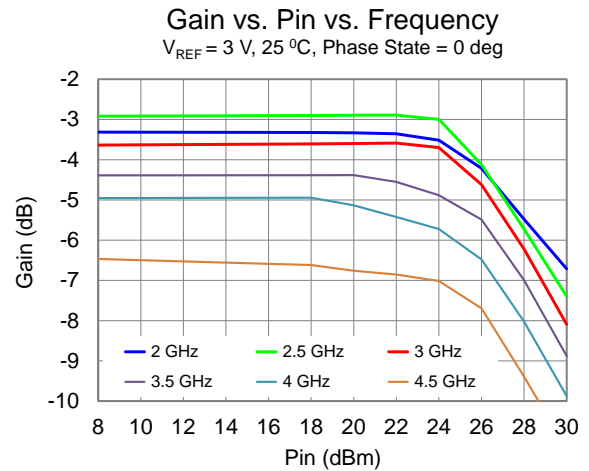
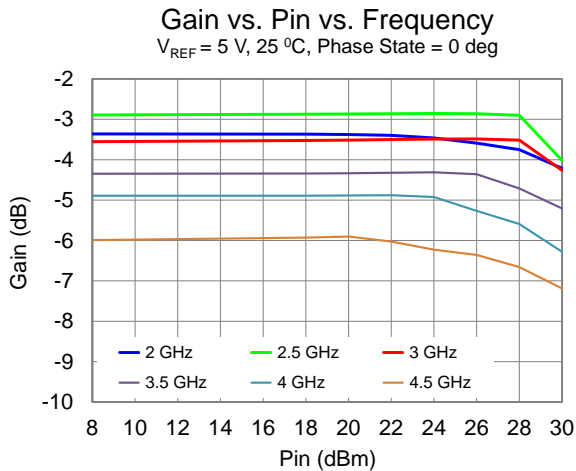
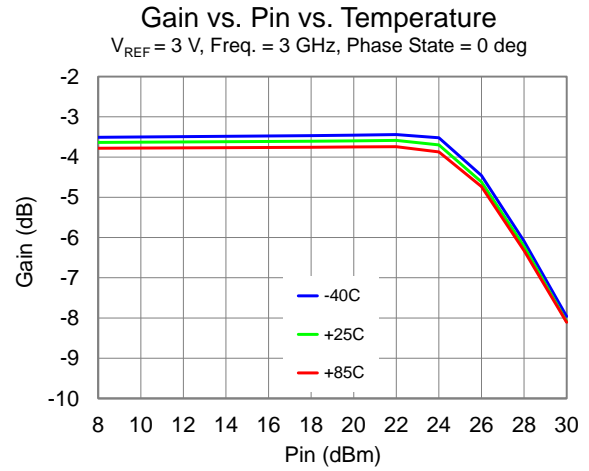
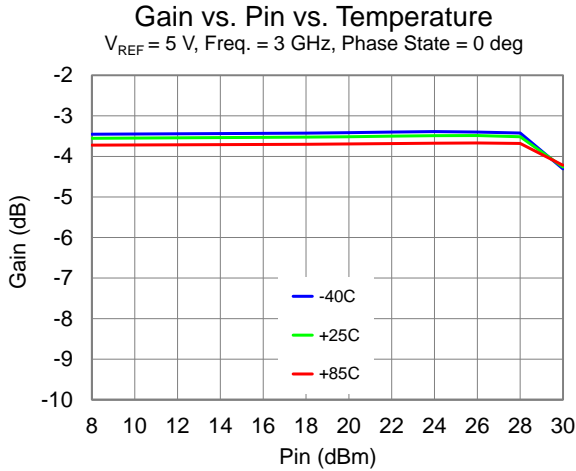

Performance Plots – Large Signal (Cont.)

Test conditions unless otherwise noted: 5V and 3V, 25 °C

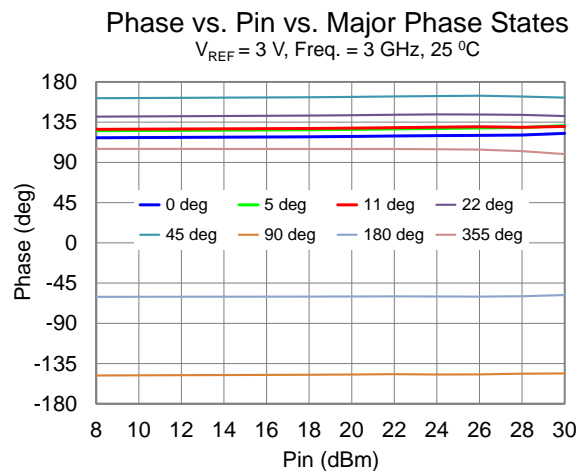
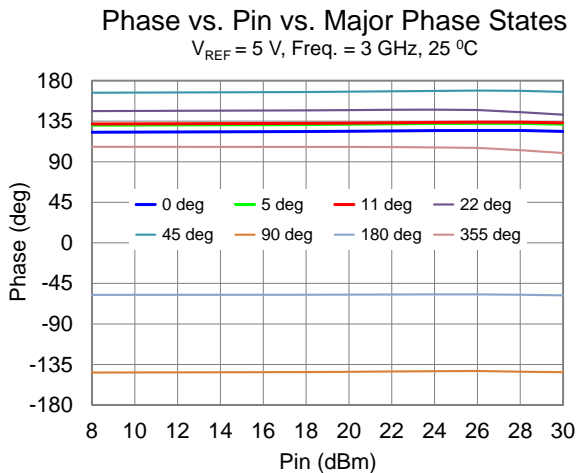
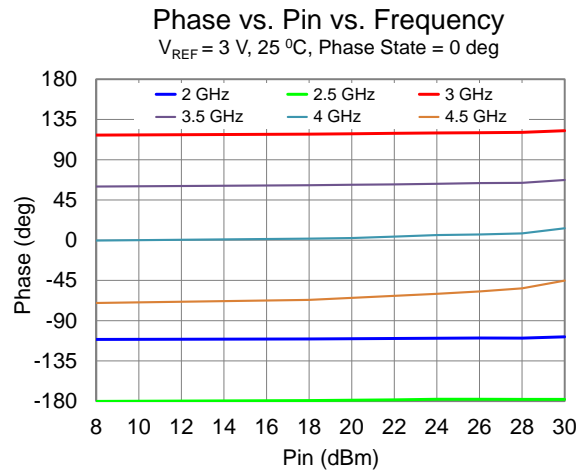
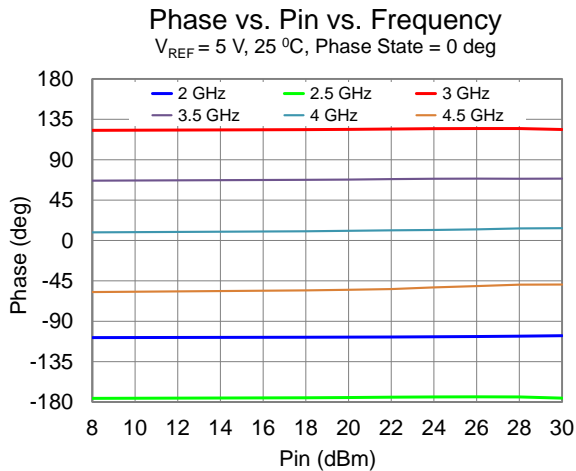
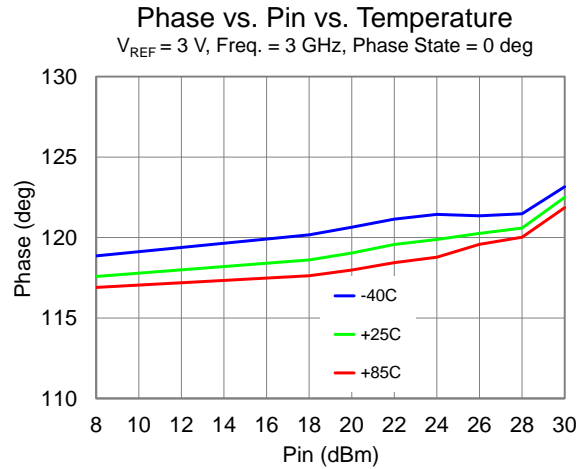
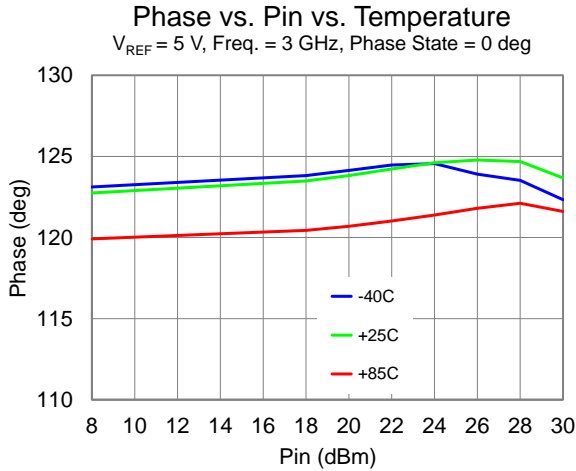

Performance Plots – Large Signal (Cont.)

Test conditions unless otherwise noted: 5V and 3V, 25 °C

Current I_{REF} vs. Pin vs. Temperature
 $V_{REF} = 5\text{ V}$, Freq. = 3 GHz, Phase State = 0 deg

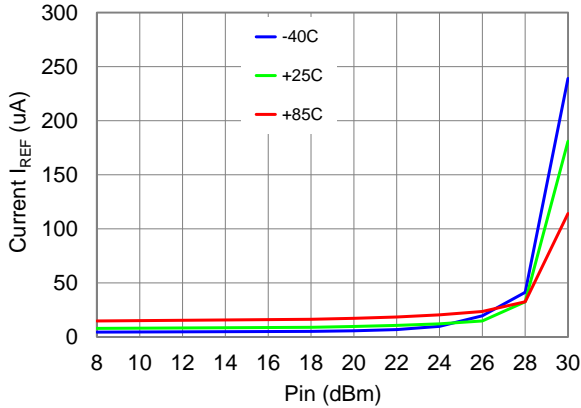

Current I_{REF} vs. Pin vs. Temperature
 $V_{REF} = 3\text{ V}$, Freq. = 3 GHz, Phase State = 0 deg

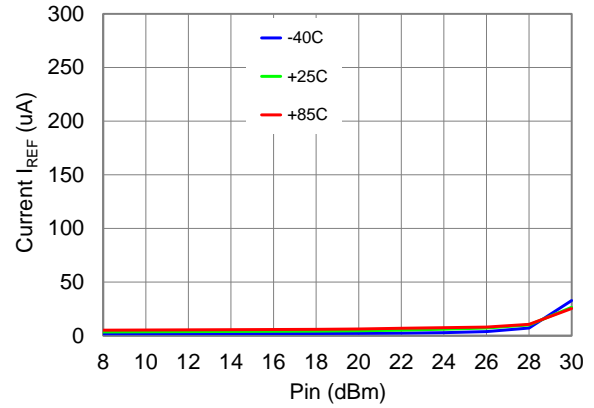

Current I_{REF} vs. Pin vs. Frequency
 $V_{REF} = 5\text{ V}$, 25 °C, Phase State = 0 deg

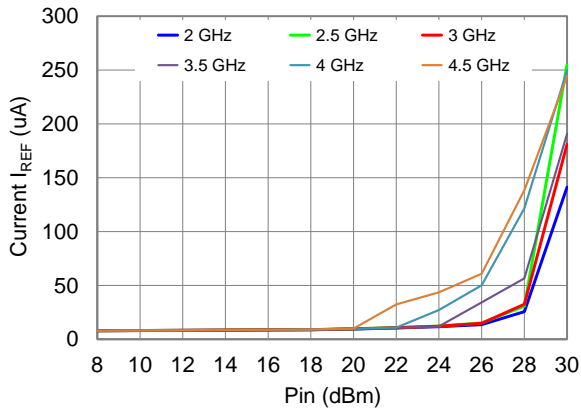

Current I_{REF} vs. Pin vs. Frequency
 $V_{REF} = 3\text{ V}$, 25 °C, Phase State = 0 deg

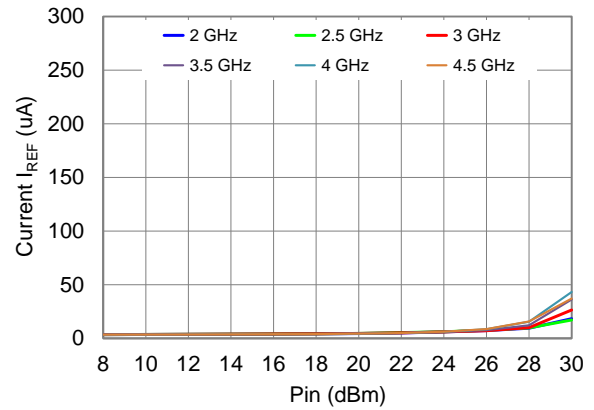

Current I_{REF} vs. Pin vs. Phase States
 $V_{REF} = 5\text{ V}$, Freq. = 3 GHz, 25 °C

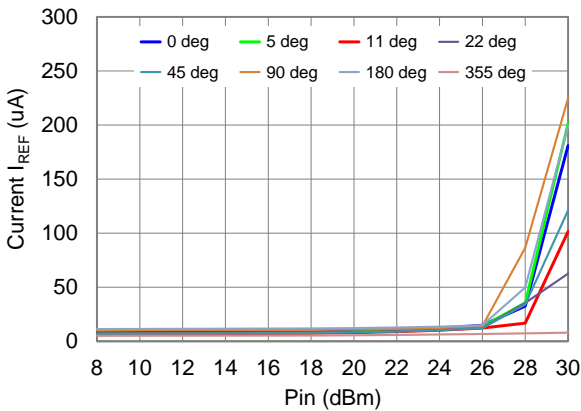

Current I_{REF} vs. Pin vs. Phase States
 $V_{REF} = 3\text{ V}$, Freq. = 3 GHz, 25 °C

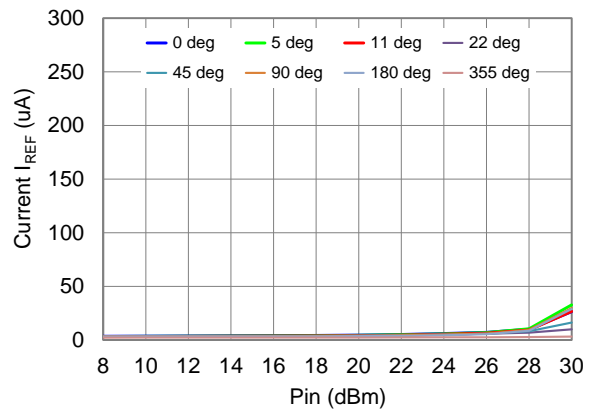

Performance Plots – Linearity

Test conditions unless otherwise noted: 5V and 3V, Tone Spacing = 10 MHz, 25 °C

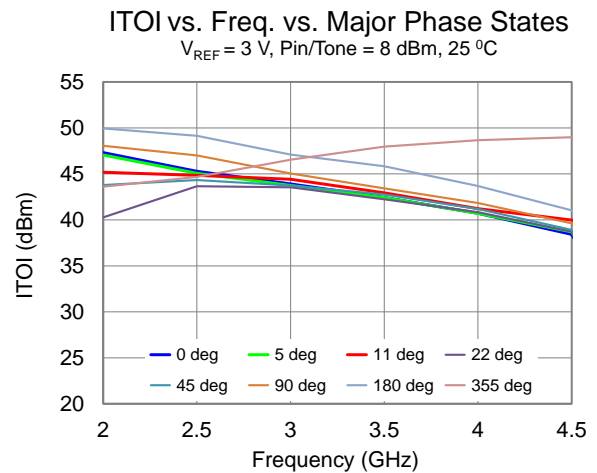
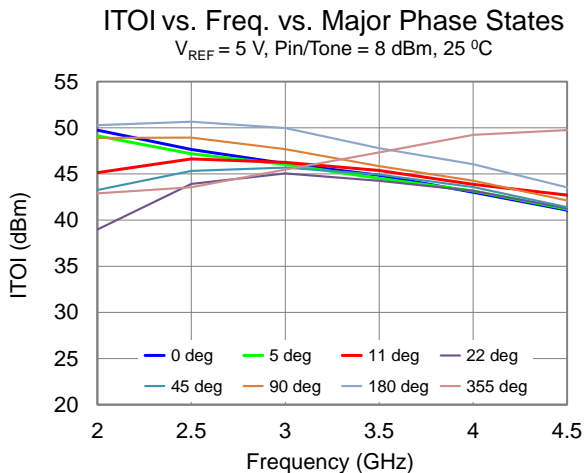
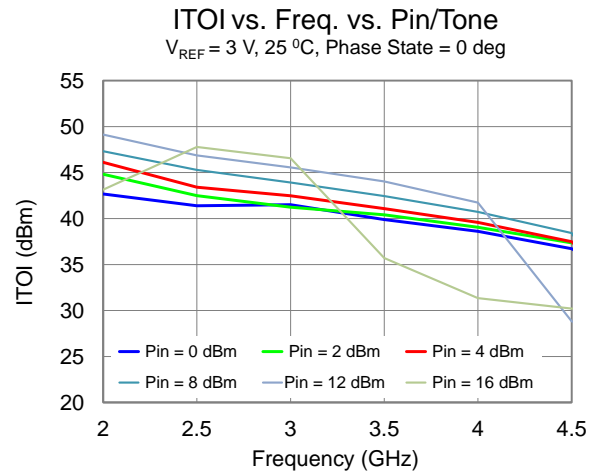
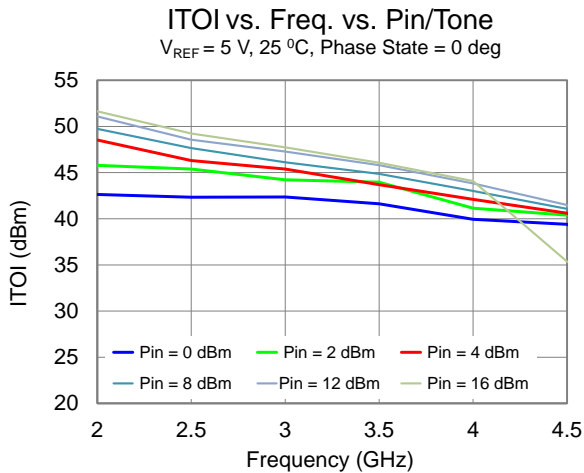
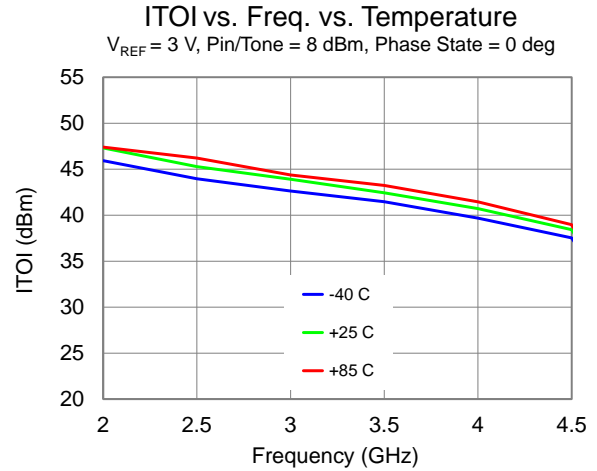
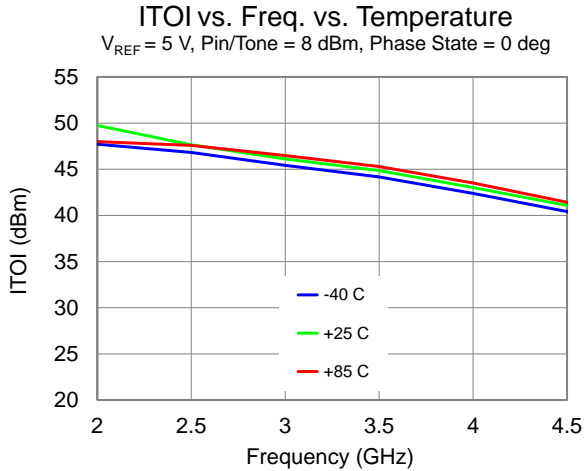

Performance Plots – Linearity (Cont.)

Test conditions unless otherwise noted: 5V and 3V, Tone Spacing = 10 MHz, 25 °C

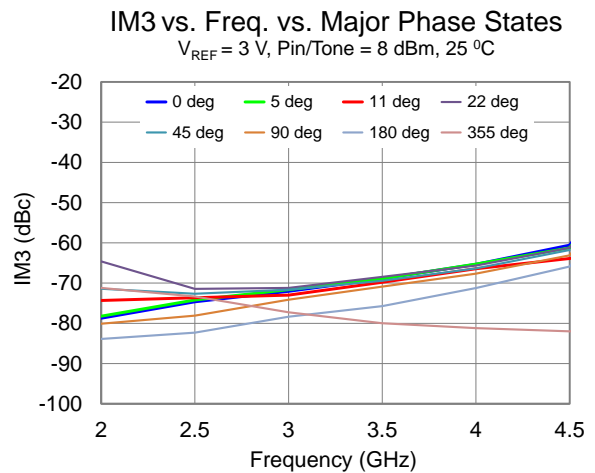
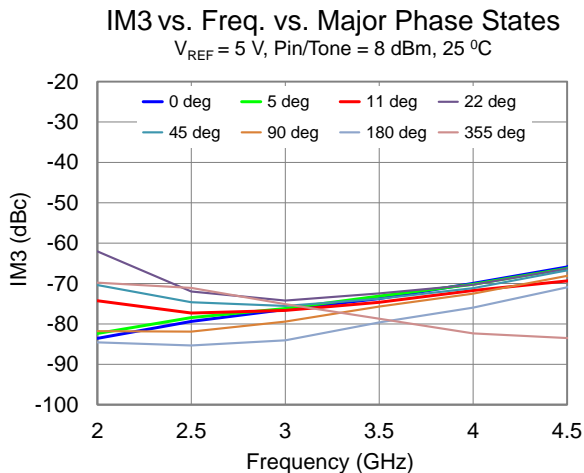
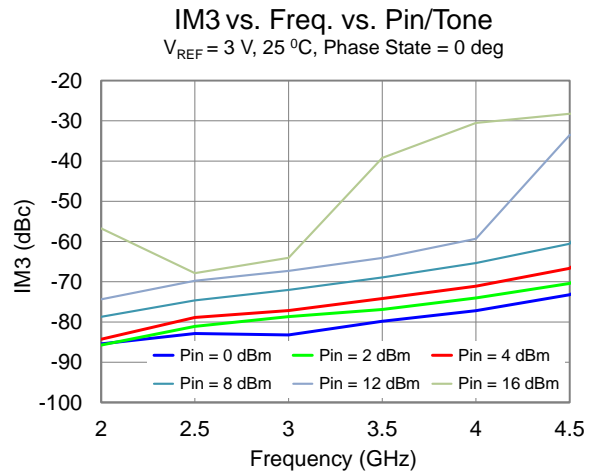
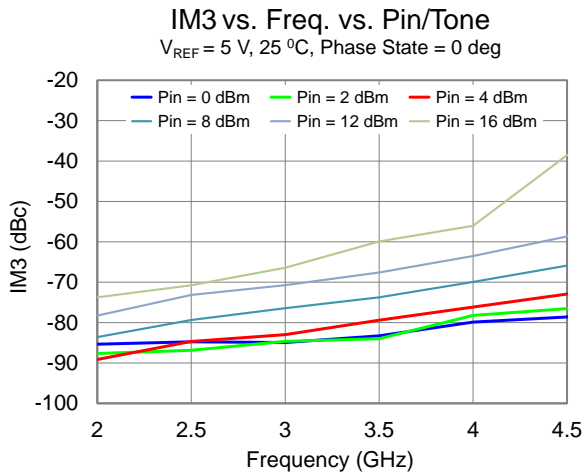
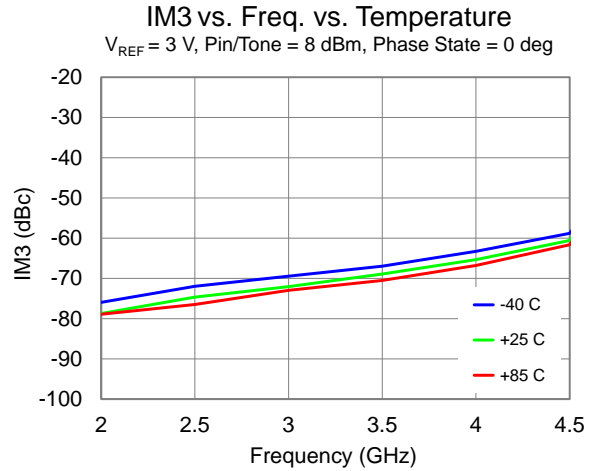
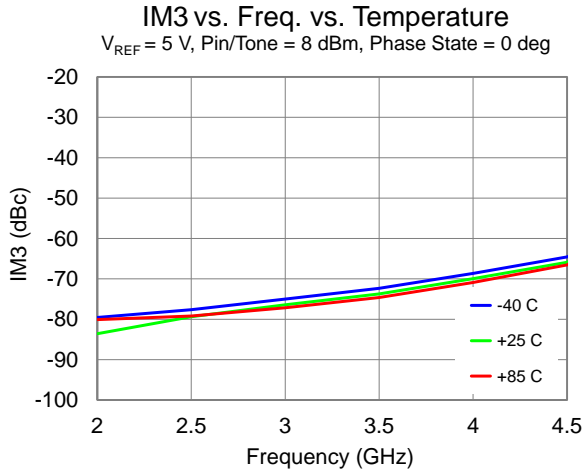

Thermal and Reliability Information

Parameter	Test Conditions	Value	Units
Channel Temperature (T_{CH})	$T_{BASE} = 85^{\circ}C$	85	$^{\circ}C$
Median Lifetime (T_M)		5.2E+9	Hrs

Notes:

- Under normal (lifetime) operating conditions, self-heating is not a significant contributor to channel temperature.

Median Lifetime

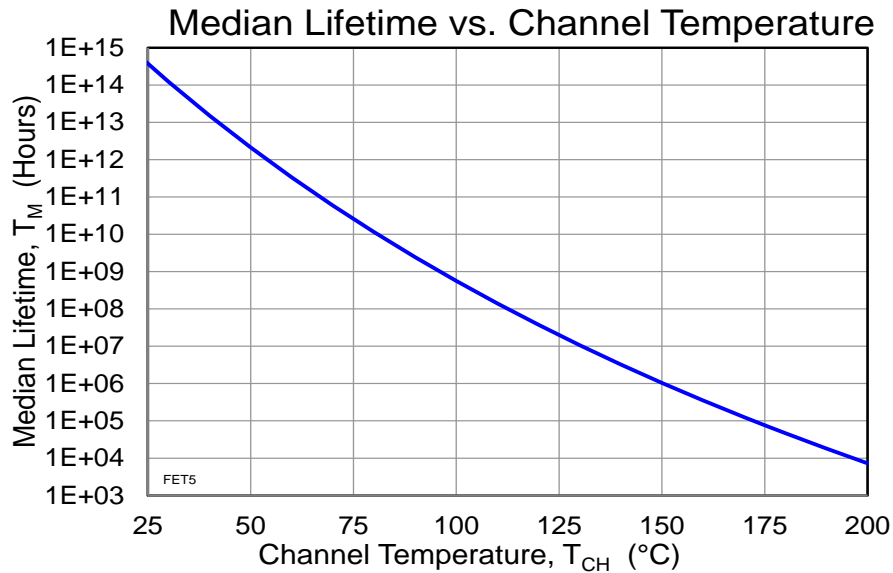

Applications Circuit

De-Quing network is not required

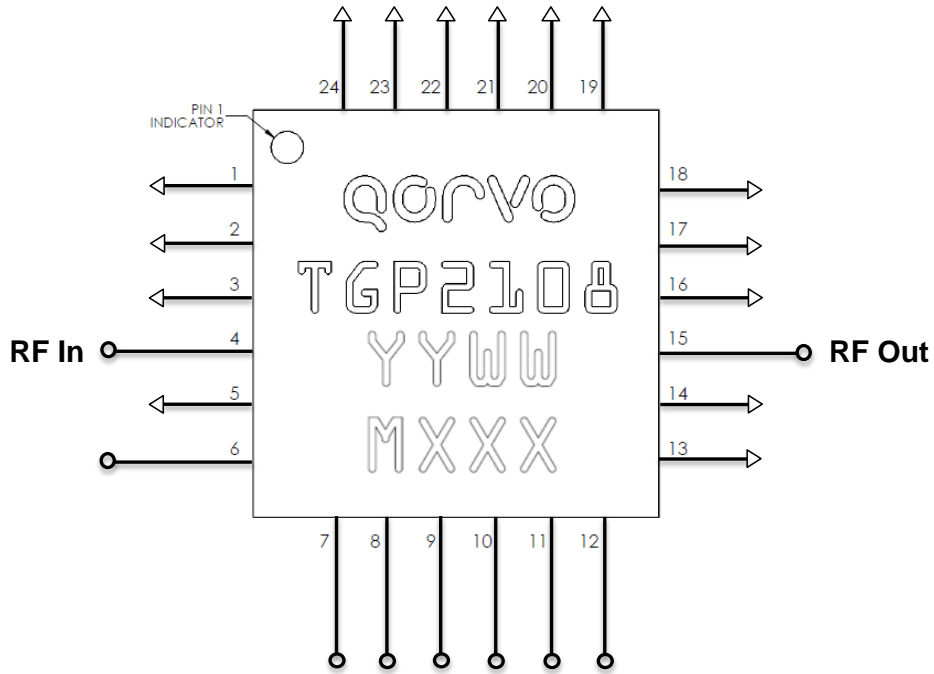

Pin Description

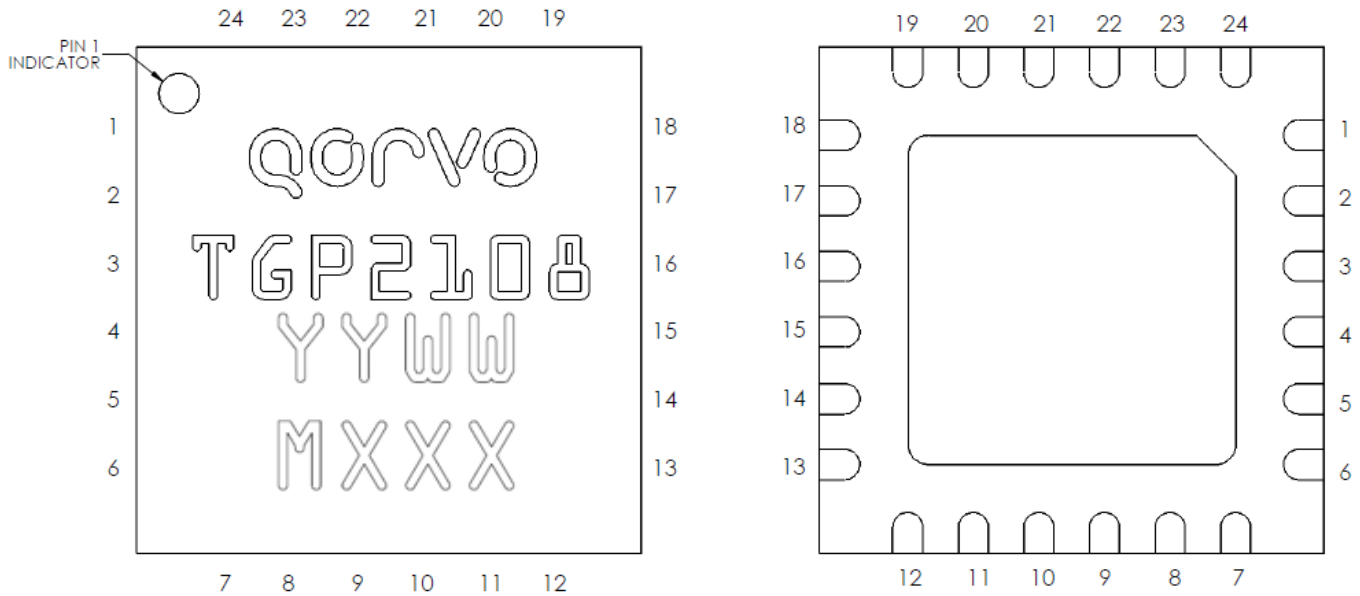

Pin No.	Symbol	Description
1-3, 5, 13-14, 16-24	N/C	No Connection; recommend GND at the EVB level
4	RF Input	Input; matched to 50 Ohms; DC blocked; interchangeable to RF Output
6	REF	Reference
7	5°	5° Bit
8	11°	11° Bit
9	22°	22° Bit
10	45°	45° Bit
11	90°	90° Bit
12	180°	180° Bit
15	RF Output	Output; matched to 50 Ohms; DC blocked; interchangeable to RF Input
25 (Slug)	GND	On PCB; multiple vias should be employed under the center pad (25) to minimize inductance and thermal resistance; see page 12 for suggested vias layout

Evaluation Board (EVB) Layout Assembly

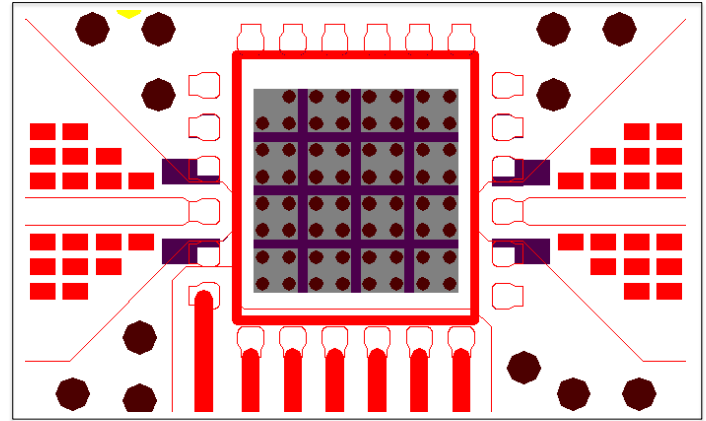
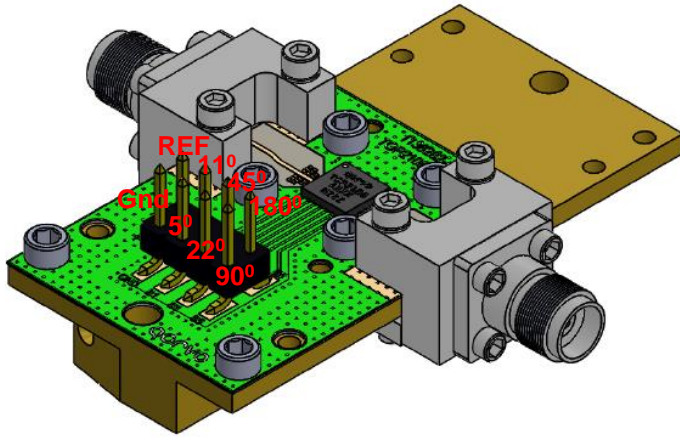

Via pattern

RF layer is 0.008" thick Rogers RO4003C. Metal layers are 0.5-oz copper. Microstrip 50 Ω line width is 0.050". The microstrip line taper at the connector interface is optimized for the Southwest Microwave end-launch connector 1092-02A-5.

Ground / thermal vias under the DUT are critical for the proper performance of this device. The PCB shown herein utilizes copper filled vias (8 mils diameter) under the DUT.

The pad pattern shown has been developed and tested for optimized assembly at Qorvo. The PCB land pattern has been developed to accommodate lead and package tolerances. Since surface mount processes vary from company to company careful process development is recommended.

De-Quing network is not required.

Mechanical Information

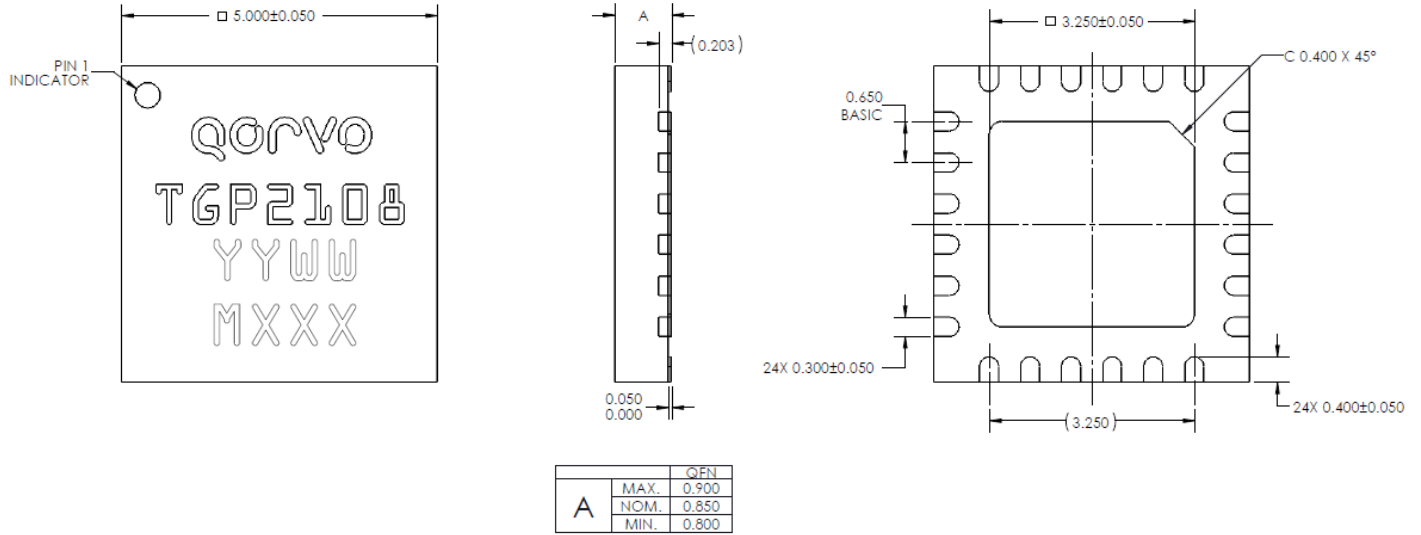

Notes:

- All dimensions are in millimeters. Angles are in degrees.
Tolerances: XX = $\pm .25$
XXX = $\pm .127$
- Package Leads Are Gold Plated (NiPdAu)
- Part Is Mold Encapsulated
- Part Marking:
2108: Part Number
YY: Part assembly Year
WW: Part Assembly Week
MXXX: Batch ID

Solderability

1. Compatible with the latest version of J-STD-020, Lead-free solder, 260 °C.
2. The use of no-clean solder to avoid washing after soldering is recommended.

Recommended Soldering Temperature Profile

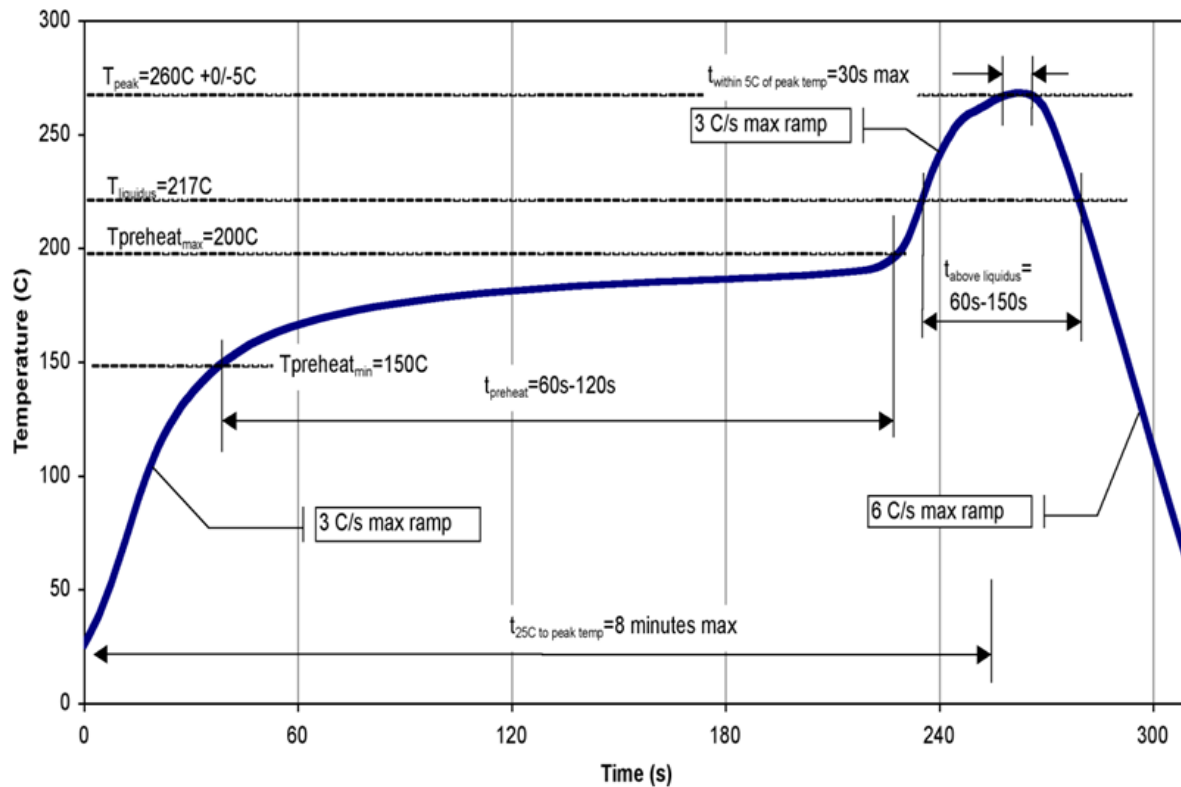

Handling Precautions

Parameter	Rating	Standard
ESD – Human Body Model (HBM)	Class 0B	ESDA / JEDEC JS-001
ESD – Charge Device Model (CDM)	Class C0a	ANSI /ESD/JEDEC JS-002
MSL – Moisture Sensitivity Level	MSL 3	IPC/JEDEC J-STD-020



Caution!
ESD-Sensitive Device

RoHS Compliance

This product is compliant with the 2011/65/EU RoHS directive (Restrictions on the Use of Certain Hazardous Substances in Electrical and Electronic Equipment), as amended by Directive 2015/863/EU. This product also has the following attributes:

- Lead Free
- Halogen Free (Chlorine, Bromine)
- Antimony Free
- TBBP-A (C₁₅H₁₂Br₄O₂) Free
- PFOS Free
- SVHC Free

Contact Information

For the latest specifications, additional product information, worldwide sales and distribution locations:

Tel: 1-844-890-8163

Web: www.qorvo.com

Email: customer.support@qorvo.com

For technical questions and application information: **Email:** appsupport@qorvo.com

Important Notice

The information contained herein is believed to be reliable; however, Qorvo makes no warranties regarding the information contained herein and assumes no responsibility or liability whatsoever for the use of the information contained herein. All information contained herein is subject to change without notice. Customers should obtain and verify the latest relevant information before placing orders for Qorvo products. The information contained herein or any use of such information does not grant, explicitly or implicitly, to any party any patent rights, licenses, or any other intellectual property rights, whether with regard to such information itself or anything described by such information. **THIS INFORMATION DOES NOT CONSTITUTE A WARRANTY WITH RESPECT TO THE PRODUCTS DESCRIBED HEREIN, AND QORVO HEREBY DISCLAIMS ANY AND ALL WARRANTIES WITH RESPECT TO SUCH PRODUCTS WHETHER EXPRESS OR IMPLIED BY LAW, COURSE OF DEALING, COURSE OF PERFORMANCE, USAGE OF TRADE OR OTHERWISE, INCLUDING THE IMPLIED WARRANTIES OF MERCHANTABILITY AND FITNESS FOR A PARTICULAR PURPOSE.**

Without limiting the generality of the foregoing, Qorvo products are not warranted or authorized for use as critical components in medical, life-saving, or life-sustaining applications, or other applications where a failure would reasonably be expected to cause severe personal injury or death.

Copyright 2019 © Qorvo, Inc. | Qorvo is a registered trademark of Qorvo, Inc.