



RoHS  **TMOV®34S Varistor Series**



**Description**

The Littelfuse TMOV®34S thermally protected varistor series consists of a 34mm square format varistor element (MOV) with an integral thermally activated element. This element is designed to open in the event of overheating due to abnormal overvoltage, limited current conditions. Certain TMOV®34S devices are offered with a "monitor" lead which may be connected to signalling circuitry to indicate if the MOV has been disconnected from the circuit. TMOV®34S Series devices offer quick thermal response due to the close proximity of the integrated thermal element to the MOV body. The integrated configuration also offers lower inductance than most discrete solutions resulting in improved clamping performance to fast over voltage transients.

**Agency Approvals**

Agency	Agency File Number	Status
	UL1449 3rd Edition	E320116
	IEC-CECC Spec: QC42201-C001, QC42201-A001, IEC 60950-1 (Annex Q)	E1274/F
	IEC 61051-1, IEC 61051-2, IEC 60950-1 (Annex Q)	40021525

**Features**

- US patent for thermally protected MOV— Patent # 6636403
- High peak current rating to 40 kA
- -55°C to +85°C operating temp
- RoHS Compliant and Lead-free Available
- Alternative design available with narrow 3mm wide monitor (right) lead
- Alternative design available with 2 leads only (no monitor lead)

**Applications**

- SPD (TVSS) Products
- AC Panel Protection Modules
- AC Line Power Supplies
- AC Power Meters
- UPS (Uninterruptable Power Supply)
- Inverters
- AC/DC Power Supplies
- DIN Rail

**TMOV®34S Series**

### Absolute Maximum Ratings

• For ratings of individual members of a series, see Device Ratings and Specifications chart

Continuous	TMOV34S Series	Units
Steady State Applied Voltage:		
AC Voltage Range ( $V_{MIACRMS}$ )	115 to 750	V
Transients:		
Peak Pulse Current ( $I_{TM}$ )		
For 8/20 $\mu$ s Current Wave, single pulse	up to 40,000	A
Single Pulse Energy Range		
For 2ms Current Wave	280 to 1200	J
Operating Ambient Temperature Range ( $T_A$ )	-55 to + 85	°C
Storage Temperature Range ( $T_{STG}$ )	-55 to + 125	°C
Temperature Coefficient (a <sup>v</sup> ) of Clamping Voltage ( $V_C$ ) at Specified Test Current	<0.01	%/°C
Hi-Pot Encapsulation (Isolation Voltage Capability)	2500	V
COATING Insulation Resistance	1000	M $\Omega$

\* Contact your Littelfuse product representative to discuss alternatives and for additional information.

CAUTION: Stresses above those listed in "Absolute Maximum Ratings" may cause permanent damage to the device. This is a stress only rating and operation of the device at these or any other conditions above those indicated in the operational sections of this specification is not implied.

### TMOV<sup>®</sup>34S Series Ratings & Specifications - Standard 3 Lead Design

Lead-free and RoHS Compliant Models		Maximum Rating (85°C)					Specifications (25°C)			
		Continuous		Transient			Varistor Voltage at 1mA Test Current	Maximum Clamping Volt V <sub>c</sub> at 200A Current (8/20μs)	Typical Capacitance f = 1MHz	
		AC Volts	DC Volts	MCOV Surge Arrester	Energy 2ms	Peak Current 8 x 20μs				
Part Number	Branding	V <sub>M(AC)RMS</sub>	V <sub>M(AC)</sub>	V <sub>M(AC)RMS</sub>	W <sub>TM</sub> 1 x Pulse	I <sub>TM</sub> 1 x Pulse	V <sub>N(DC) Min</sub>	V <sub>N(DC) Max</sub>	V <sub>c</sub>	C
		(V)	(V)	(V)	(J)	(A)	(V)	(V)	(V)	(pF)
TMOV34S111MP	TMOV34S111MP	115	150	98	280	40000	163	202	305	11500
TMOV34S131MP	TMOV34S131MP	130	175	111	310	40000	184	228	345	10000
TMOV34S141MP	TMOV34S141MP	140	188	119	340	40000	198	248	375	9000
TMOV34S151MP	TMOV34S151MP	150	200	128	360	40000	212	268	405	8000
TMOV34S181MP	TMOV34S181MP	180	240	153	400	40000	254	312	488	6800
TMOV34S201MP	TMOV34S201MP	200	265	170	430	40000	283	357	540	6500
TMOV34S251MP	TMOV34S251MP	250	330	213	490	40000	354	429	650	5000
TMOV34S271MP	TMOV34S271MP	275	369	234	550	40000	389	473	730	4500
TMOV34S301MP	TMOV34S301MP	300	400	255	590	40000	433	528	780	4050
TMOV34S321MP	TMOV34S321MP	320	420	272	640	40000	462	561	830	3800
TMOV34S331MP	TMOV34S331MP	330	435	281	650	40000	476	581	855	3700
TMOV34S351MP	TMOV34S351MP	350	460	298	700	40000	505	616	910	3500
TMOV34S391MP	TMOV34S391MP	385	506	327	800	40000	555	678	1005	3300
TMOV34S421MP	TMOV34S421MP	420	560	357	910	40000	610	748	1130	3000
TMOV34S461MP	TMOV34S461MP	460	610	391	960	40000	642	783	1188	2800
TMOV34S481MP	TMOV34S481MP	480	640	408	960	40000	670	825	1240	2700
TMOV34S511MP	TMOV34S511MP	510	675	434	960	40000	735	910	1350	2500
TMOV34S551MP	TMOV34S551MP	550	700	468	965	40000	770	939	1415	2250
TMOV34S571MP	TMOV34S571MP	575	730	489	990	40000	805	1000	1480	2200
TMOV34S621MP	TMOV34S621MP	620	800	527	1010	40000	880	1074	1589	2100
TMOV34S661MP	TMOV34S661MP	660	850	561	1030	40000	940	1160	1720	2000
TMOV34S681MP	TMOV34S681MP	680	890	578	1100	40000	980	1195	1772	1970
TMOV34S751MP	TMOV34S751MP	750	970	638	1200	40000	1080	1320	2000	1800

Notes :

Same ratings and specifications apply to 2 leaded alternative design. Replace 'M' with 'E' in part number. Refer to Part Numbering System at the end of this document.

### TMOV®34S Series Ratings & Specifications - Alternative 2 Lead Design

Lead-free and RoHS Compliant Models		Maximum Rating (85°C)					Specifications (25°C)			
		Continuous		Transient			Varistor Voltage at 1mA Test Current	Maximum Clamping Volt $V_C$ at 200A Current (8/20 $\mu$ s)	Typical Capacitance $f = 1$ MHz	
		AC Volts	DC Volts	MCOV Surge Arrester	Energy 2ms	Peak Current 8 x 20 $\mu$ s				
Part Number	Branding	$V_{M(AC)RMS}$ (V)	$V_{M(AC)}$	$V_{M(AC)RMS}$ (V)	$W_{TM}$ 1 x Pulse (J)	$I_{TM}$ 1 x Pulse (A)	$V_{N(DC)} Min$ (V)	$V_{N(DC)} Max$ (V)	$V_C$ (V)	C (pF)
TMOV34S111EP	TMOV34S111EP	115	150	98	280	40000	163	202	305	11500
TMOV34S131EP	TMOV34S131EP	130	175	111	310	40000	184	228	345	10000
TMOV34S141EP	TMOV34S141EP	140	188	119	340	40000	198	248	375	9000
TMOV34S151EP	TMOV34S151EP	150	200	128	360	40000	212	268	405	8000
TMOV34S181EP	TMOV34S181EP	180	240	153	400	40000	254	312	488	6800
TMOV34S201EP	TMOV34S201EP	200	265	170	430	40000	283	357	540	6500
TMOV34S251EP	TMOV34S251EP	250	330	213	490	40000	354	429	650	5000
TMOV34S271EP	TMOV34S271EP	275	369	234	550	40000	389	473	730	4500
TMOV34S301EP	TMOV34S301EP	300	400	255	590	40000	433	528	780	4050
TMOV34S321EP	TMOV34S321EP	320	420	272	640	40000	462	561	830	3800
TMOV34S331EP	TMOV34S331EP	330	435	281	650	40000	476	581	855	3700
TMOV34S351EP	TMOV34S351EP	350	460	298	700	40000	505	616	910	3500
TMOV34S391EP	TMOV34S391EP	385	506	327	800	40000	555	678	1005	3300
TMOV34S421EP	TMOV34S421EP	420	560	357	910	40000	610	748	1130	3000
TMOV34S461EP	TMOV34S461EP	460	610	391	960	40000	642	783	1188	2800
TMOV34S481EP	TMOV34S481EP	480	640	408	960	40000	670	825	1240	2700
TMOV34S511EP	TMOV34S511EP	510	675	434	960	40000	735	910	1350	2500
TMOV34S551EP	TMOV34S551EP	550	700	468	965	40000	770	939	1415	2250
TMOV34S571EP	TMOV34S571EP	575	730	489	990	40000	805	1000	1480	2200
TMOV34S621EP	TMOV34S621EP	620	800	527	1010	40000	880	1074	1589	2100
TMOV34S661EP	TMOV34S661EP	660	850	561	1030	40000	940	1160	1720	2000
TMOV34S681EP	TMOV34S681EP	680	890	578	1100	40000	980	1195	1772	1970
TMOV34S751EP	TMOV34S751EP	750	970	638	1200	40000	1080	1320	2000	1800

Notes :  
 Same ratings and specifications apply to 3 leaded design. Replace 'E' with 'M' in part number. Refer to Part Numbering System at the end of this document.

**Typical time to open circuit under UL1449 Abnormal Overvoltage Limited Current Test**

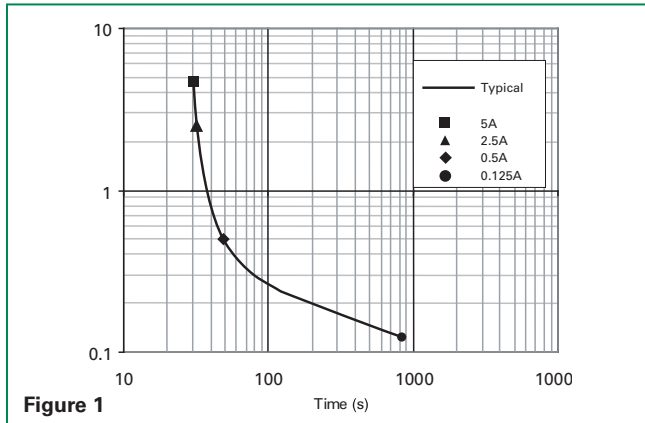

**Figure 1**

Note: The Industrial TMOV<sup>®</sup> Series TMOV<sup>®</sup>34S devices are intended, in conjunction with appropriate enclosure design, to help facilitate SPD module compliance to UL 1449, Section 37.4 (Abnormal Overvoltage Limited Current Requirements). Under these extreme abnormal overvoltage conditions, the units will exhibit substantial heating and potential venting prior to opening. Modules should be designed to contain this possibility. Application testing is strongly recommended.

**Peak Current & Energy Derating Curve**

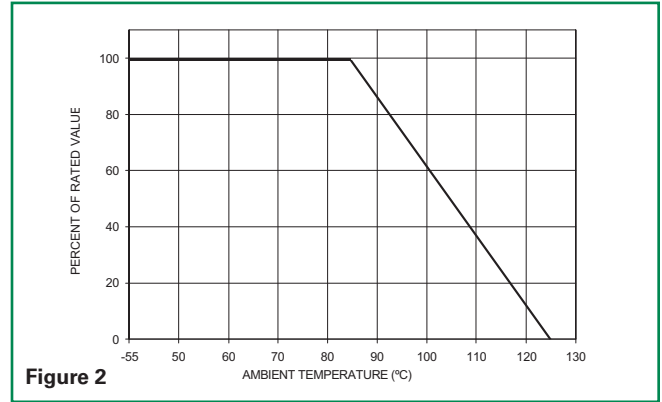

**Figure 2**

For applications exceeding 85°C ambient temperature, the peak surge current and energy ratings must be reduced as shown.

**Pulse Rating Curve**

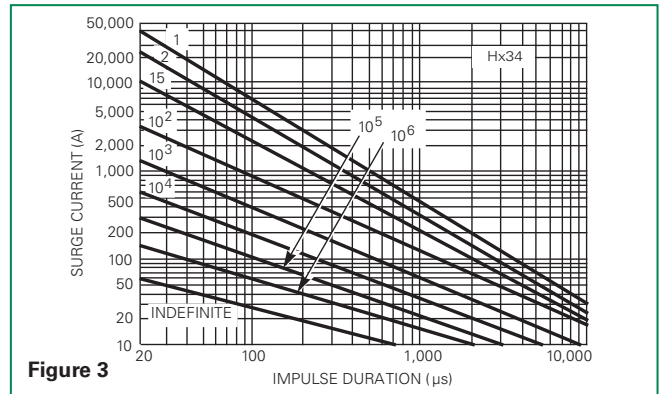

**Figure 3**

**V-I Characteristic Curves for TMOV<sup>®</sup>34S Varistor**

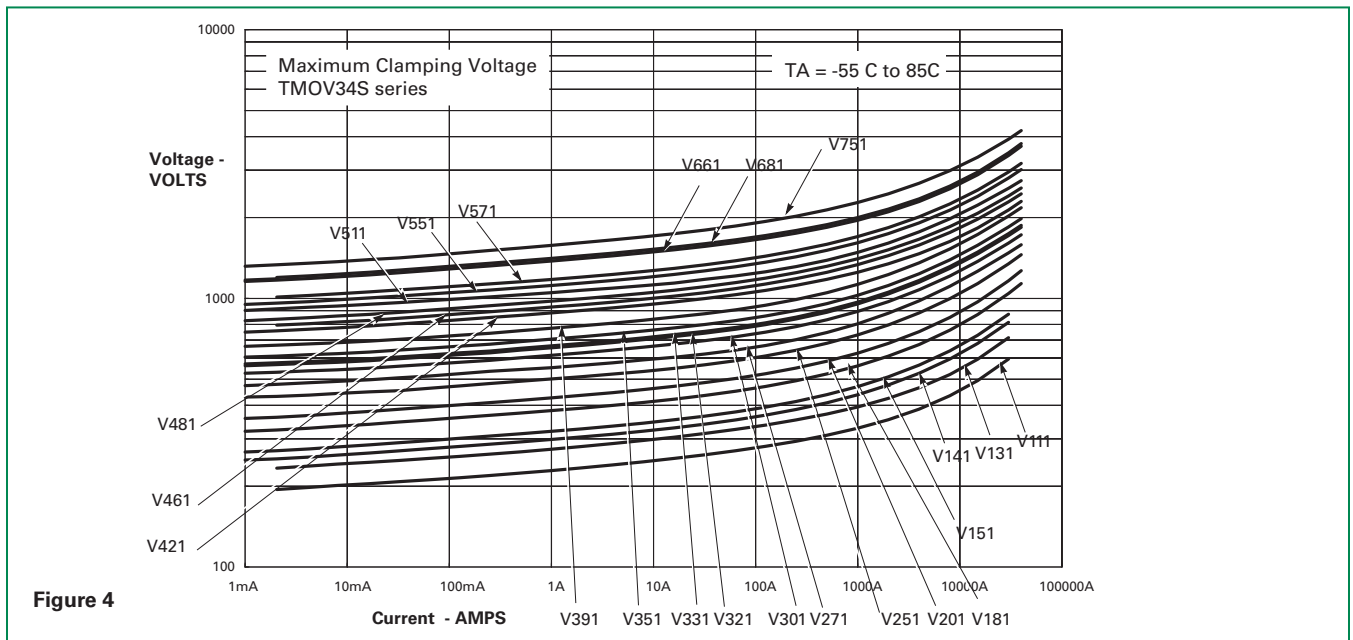
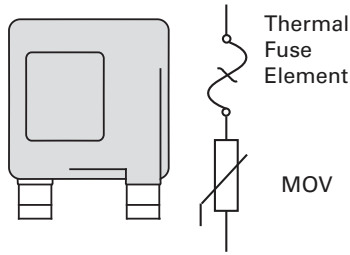

**Figure 4**

TMOV<sup>®</sup>34S Series

### Lead Configurations

#### TMOV®34S "E" 2-Lead Varistor



#### TMOV®34S "M" 3-Lead Varistor

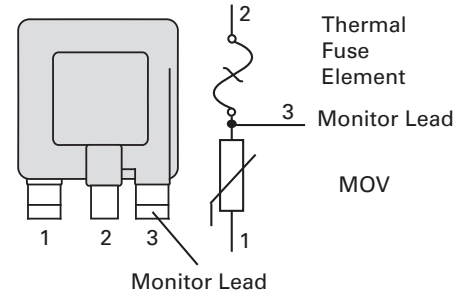

Note: MOVs are non-polarized passive elements

### TMOV®34S Varistor Application Examples

The application examples below show how the monitor lead on the TMOV®34S can be used to indicate that the thermal element has been opened. This signifies that the circuit is no longer protected from transients by the MOV.

#### Application Example 1

In this case, the LED is normally on, and is off when the thermal element opens.

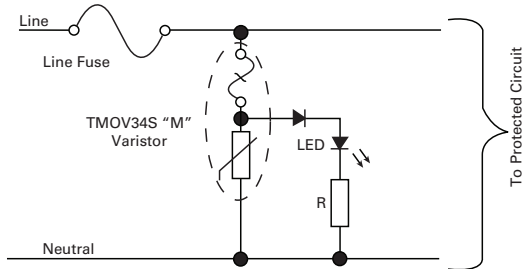

#### Application Example 2

This circuit utilizes an optocoupler to provide galvanic isolations between the TMOV®34S varistor and the indicating or alarm circuitry.

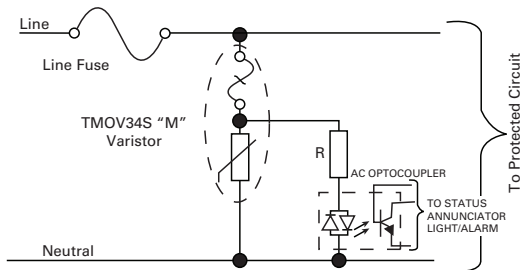

#### Application Example 3

This circuit illustrates the use of the monitoring lead of the TMOV®34S varistor to ensure that equipment is only operated when overvoltage protection is present. In normal operation the load switch relay solenoid is powered via the monitor lead of the TMOV®34S varistor. In the event of the thermal element being activated, the relay will de-activate, cutting power to the protected circuit and the fault LED will illuminate.

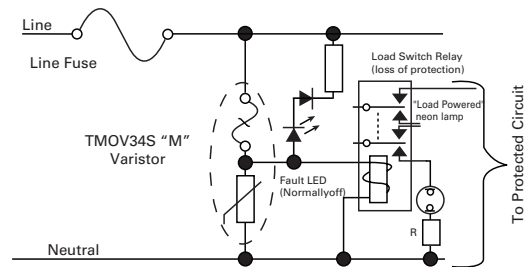

Please note: Indicator circuits are provided as a guideline only. Verification of actual indicator circuitry is the responsibility of the end user. Component values selected must be appropriate for the specific AC line voltage service and application.

### Wave Solder Profile

Because the TMOV®34S Series varistors contain a thermal protection device, care must be taken when soldering the devices into place. Two soldering methods are possible. Firstly, hand soldering:

It is recommended to heat-sink the leads of the device. Secondly, wave-soldering: It is critically important that all preheat stage and the solder bath temperatures are rigidly controlled.

### Non Lead-free Profile

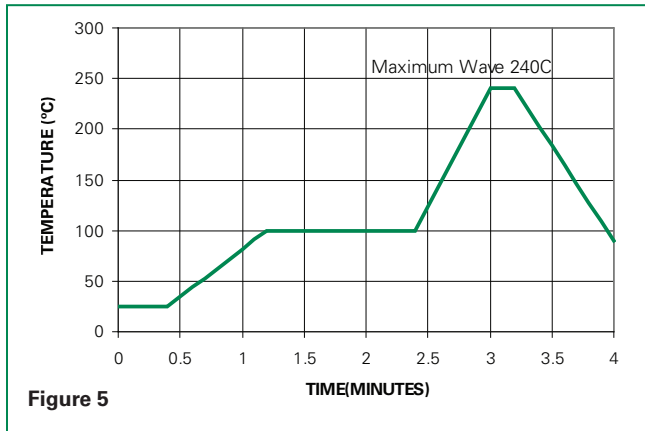

Figure 5

### Lead-free Profile

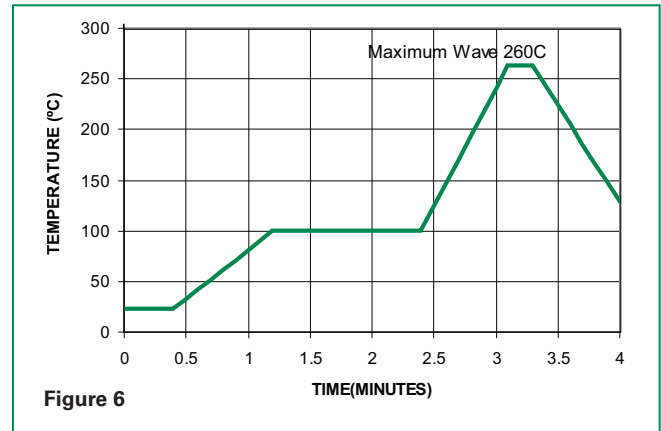

Figure 6

### Physical Specifications

<b>Lead Material</b>	Tin-plated Copper
<b>Soldering Characteristics</b>	Solderability per MIL-STD-202, Method 208E
<b>Insulating Material</b>	Cured, flame retardant epoxy polymer meets UL94V-0 requirements.
<b>Device Labeling</b>	Marked with LF, part identifier, and date code

### Environmental Specifications

<b>Operating/Storage Temperature</b>	-55°C to +85°C/ -55°C to +125°C
<b>Humidity Aging</b>	+85°C, 85% RH, 1000 hours +/-10% voltage
<b>Thermal Shock</b>	+85°C to -40°C 5 times +/-10% voltage
<b>Solvent Resistance</b>	MIL-STD-202, Method 215F
<b>Moisture Sensitivity</b>	Level 1, J-STD-020C

### Part Numbering System

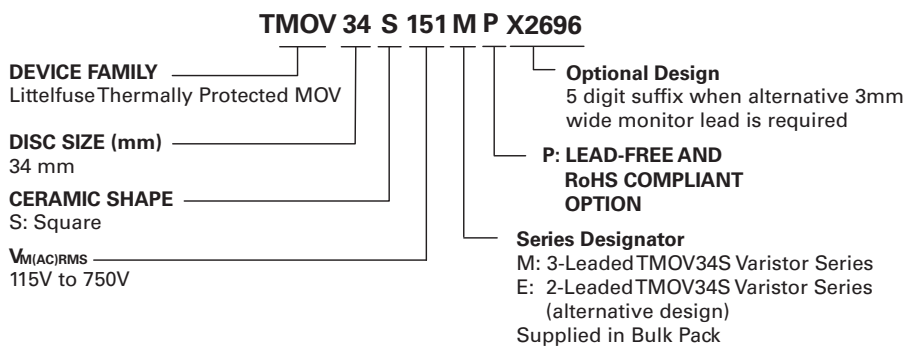

TMOV®34S Series

### Dimensions 3 Leaded Series

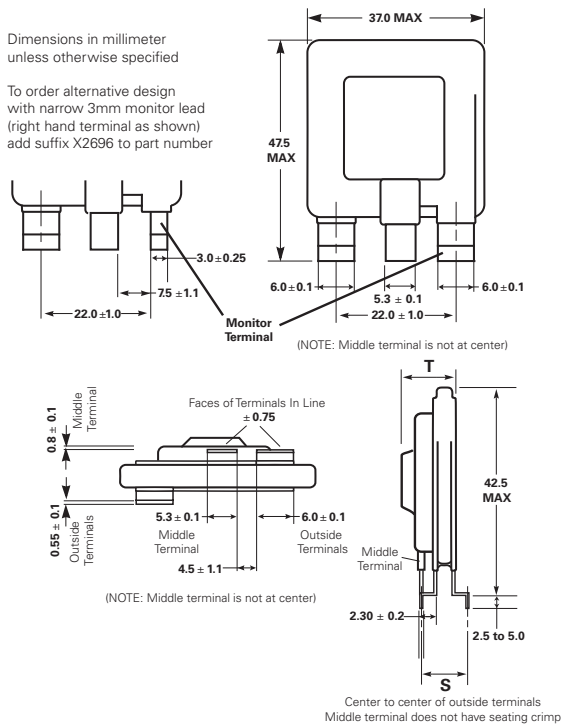

Part Number	"T" Max Body Thickness	"S" Mounting Terminal Offset
TMOV34S111M(P)	11.90	5.2 -/+ .65
TMOV34S131M(P)	12.20	5.5 -/+ .65
TMOV34S141M(P)	12.30	5.7 -/+ 0.85
TMOV34S151M(P)	12.40	5.9 -/+ 0.85
TMOV34S181M(P)	12.80	6.3 -/+ 0.85
TMOV34S201M(P)	13.00	6.5 -/+ 0.85
TMOV34S251M(P)	12.75	6.25 -/+ 0.85
TMOV34S271M(P)	12.95	6.5 -/+ 0.85
TMOV34S301M(P)	13.30	6.8 -/+ 1.0
TMOV34S321M(P)	13.50	6.9 -/+ 1.0
TMOV34S331M(P)	13.60	7.2 -/+ 1.0
TMOV34S351M(P)	13.80	7.4 -/+ 1.0
TMOV34S391M(P)	14.20	7.6 -/+ 1.0
TMOV34S421M(P)	14.50	7.85 -/+ 1.0
TMOV34S461M(P)	14.75	8.15 -/+ 1.0
TMOV34S481M(P)	14.95	8.25 -/+ 1.0
TMOV34S511M(P)	15.40	8.6 -/+ 1.0
TMOV34S551M(P)	15.60	8.65 -/+ 1.0
TMOV34S571M(P)	15.90	8.85 -/+ 1.0
TMOV34S621M(P)	16.40	9.25 -/+ 1.0
TMOV34S661M(P)	16.85	9.65 -/+ 1.0
TMOV34S681M(P)	17.20	9.85 -/+ 1.0
TMOV34S751M(P)	17.80	10.65 -/+ 1.0

### Dimensions - Alternative 2 Leaded Series

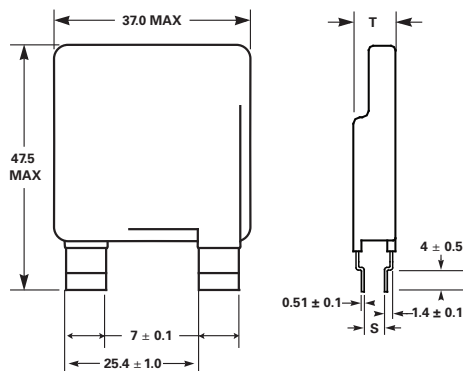

Part Number	T Dimension Max Body Thickness	S Dimension -- Mounting Terminal Offset
TMOV34S111EP	11.9	2.8 -/+ .65
TMOV34S131EP	12.2	2.9 -/+ .65
TMOV34S141EP	12.3	3.0 -/+0.85
TMOV34S151EP	12.4	3.1 -/+0.85
TMOV34S181EP	12.8	3.4 -/+0.85
TMOV34S201EP	13.0	3.6 -/+0.85
TMOV34S251EP	12.8	4.0 -/+0.85
TMOV34S271EP	13.0	4.3 -/+0.85
TMOV34S301EP	13.3	4.5 -/+1.0
TMOV34S321EP	13.5	4.7 -/+1.0
TMOV34S331EP	13.6	4.8 -/+1.0
TMOV34S351EP	13.8	5.0 -/+1.0
TMOV34S391EP	14.2	5.4 -/+1.0
TMOV34S421EP	14.5	5.7 -/+1.0
TMOV34S461EP	14.8	5.9 -/+1.0
TMOV34S481EP	15.0	6.1 -/+1.0
TMOV34S511EP	15.4	6.6 -/+1.0
TMOV34S551EP	15.6	6.8 -/+1.0
TMOV34S571EP	15.9	7.1 -/+1.0
TMOV34S621EP	16.4	7.5 -/+1.0
TMOV34S661EP	16.9	7.9 -/+1.0
TMOV34S681EP	17.2	8.2 -/+1.0
TMOV34S751EP	17.8	8.8 -/+1.0