

INTRODUCTIONS

1. Direct PC board mounting for easy installation and space saving.
2. ME2: UL.

ME3D:
ME3:
ME3G:
ME3B:
ME3DA/GA:
15ME2/ME3:
02ME4E2:
ME4/P: UL, CSA, TUV

UL, CSA, VDE,

COMPONENTS

PART NO.	C1 (uF)	L1 (mH)	PART NO.	C1 (uF)	L1 (mH)
01ME2	0.1	3.7	03ME3G-R/(S)	0.1	2.5
01ME3/(S)	0.033	5	03ME4/P	0.47	15
02ME3G/(S)	0.1	7	06ME2	0.1	0.4
02ME3GA/(S)			06ME3/(S)	0.033	0.6
02ME3G-R/(S)	0.47	25	06ME3D/(S)	0.047	0.53
02ME4E1			06ME3DA/(S)		
*02ME4E2	0.22	25	06ME3G/(S)	0.1	0.8
*02MP1		20	06ME3GA/(S)		
*02MP2		25	06ME3G-R(S)		
03ME2	0.1	1.3	10ME2	0.1	0.1
03ME2A	0.1	2.5	10ME3/(S)	0.033	0.18
03ME3/(S)	0.033	2.3	10ME3G/(S)	0.1	0.2
03ME3G/(S)	0.1	2.5	10ME3		
*03ME3GA/(S)			** 15ME2	0.1	0.12
*03ME3B			** 15ME3/(S)		
03ME3DA/(S)	0.047	1.2			
03ME3D/(S)					

- * UL, CSA approved to 2.5A 115/250VAC
- 03ME3D/(S): 03ME3D, 03ME3D(S)
- VDE, SEV, SEMKO approved to 10A/250VAC

MINIMUM INSERTION LOSS IN dB

COMMON MODE (L-G) IN 50 OHM SYSTEM															
TYPE	CURRENT RATING	FREQUENCY-MHz						TYPE	CURRENT RATING	FREQUENCY-MHz					
		.15	.50	1.0	5.0	10	30			.15	50	1.0	5.0	10	30
01ME2	1A	27	37	42	44	45	35	03ME3G	3A	20	25	30	38	40	40
01ME3/(S)	1A	25	35	40	40	40	40	03ME3GA	3A	20	23	30	40	40	40
02ME3G/(S)	2A	28	35	28	38	40	40	06ME2	6A	12	18	20	35	40	50
02ME3GA/(S)	2A	20	25	35	40	40	40	06ME3	6A	12	20	25	40	45	45
02ME4E1	2A	35	45	45	35	35	35	06ME3D	6A	10	20	20	30	35	40
02ME4E2	2.5/2A	30	40	40	35	35	40	06ME3DA	6A	8	10	15	30	30	40
02ME4/P	2A	35	45	45	35	35	35	06ME3G	6A	10	15	20	35	40	40
02MP1	2.5/2A	45	60	60	45	40	25	06ME3GA	6A	10	15	20	30	35	40
02MP2	2.5/2A	50	55	55	50	40	25	10ME3/(S)	10A	4	10	15	30	38	45
03ME2	3A	15	28	32	45	45	50	10ME3G/(S)	10A	4	10	13	28	35	40
03ME3	3A	22	30	35	45	45	48	15ME2	15A/10A	2	8	10	20	25	40
03ME3B	3A	12	20	28	40	40	40	15ME3/(S)	15A/10A	2	8	10	20	25	40
03ME3D	3A	18	28	39	48	48	55								
03ME3DA	3A	15	25	30	40	40	45								
03ME4/P	3A	30	40	40	35	35	35								

SPECIFICATIONS

1. Maximum leakage current each
line-to-ground @ 115VAC 60Hz: 0.20mA
0.45mA (02ME4E1)
@ 250VAC 50Hz: 0.40mA
0.80mA (02ME4E1)
2. Hipot rating (one minute)
line-to-ground: 2250VDC
line-to-line: 1450VDC
3. Operating frequency: 50/60Hz
4. Rated voltage: 115/250VAC

ELECTRICAL SCHEMATIC

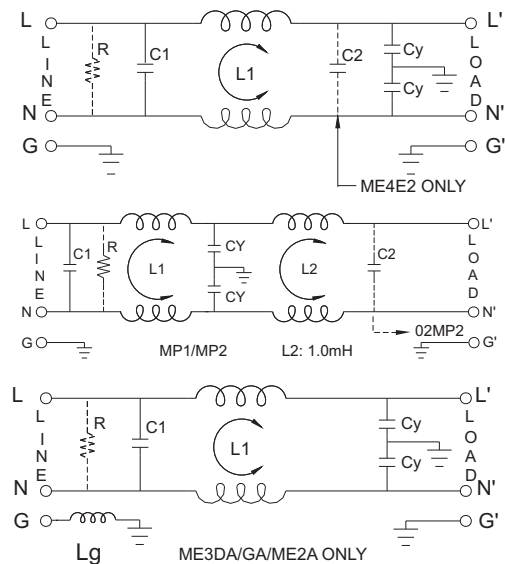

- R: 1MΩ(ME3) C2: 0.1μF(ME4E2/MP2)
- R: 560KΩ(ME4) R: 330KΩ(ME4E2)
- Cy: 2200pF
- Cy: 4700pF(ME4/E1)
- Lg: 18.3μH (2A/GA/DA)



◆ **Proposal of installation for ME3 series please follow these steps to install:**

1. Insert filter to PCB and soldering.
2. Screw panel and filter on PCB.
3. Assemble case with PCB with panel and filter.

Note: - Socket of filter should be assembled with mounting hole of case tightly for easy insertion of power cord.
 - Screw from the outside of case to fix filter for more secured assembly (optional).



ME3



ME3DA



MOUNTING DIMENSIONS OF PC BOARD

SUGGESTED MOUNTING CUTOUT (MOUNTING DIMENSIONS OF SOCKET)

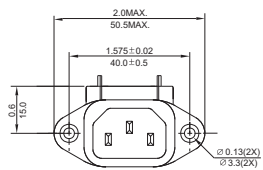
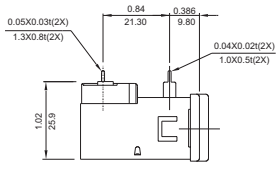

ME4E

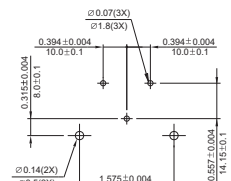
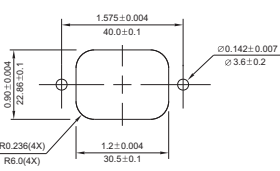
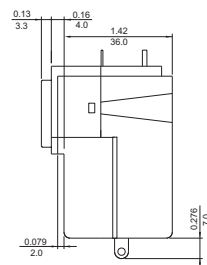
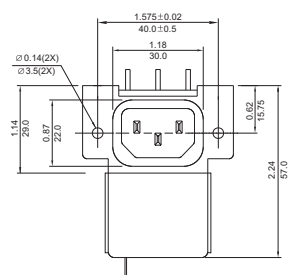

SUGGESTED MOUNTING CUTOUT (MOUNTING DIMENSIONS OF SOCKET)

MOUNTING DIMENSIONS OF PC BOARD

UNIT: INCH
mm

IEC INLET PC BOARD MOUNTING FILTERS