

## Features

- Voltage Operation as low as 1.6 V
- Insertion Loss: 0.20 dB @ 1 GHz
- Lead-Free 1 mm 6-Lead PDFN Package
- RoHS\* Compliant and 260°C Reflow Compatible

## Description

M/A-COM's MASW-009444 is a GaAs PHEMT MMIC single pole two throw (SP2T) switch in a miniature 1x1mm 6-lead PDFN package. The MASW-009444 is ideally suited for applications where low control voltage, low insertion loss, moderate isolation, and small size are required.

Typical applications are for filter and antenna switching in handset systems that connect separate receive functions to a common antenna, as well as other related handset and general purpose applications. This part can be used in all systems operating up to 6 GHz requiring high power at low control voltage.

The MASW-009444 is fabricated using a 0.5 micron gate length GaAs PHEMT process. The process features full passivation for performance and reliability.

## Functional Diagram

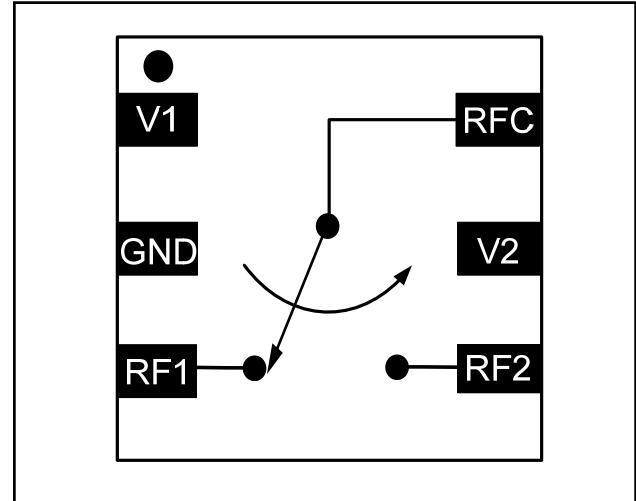

## Pin Configuration

Pin No.	Function	Description
1	V1	Control 1
2	GND	Ground
3	RF1	RF Port 1
4	RF2	RF Port 2
5	V2	Control 2
6	RFC	RF Common

## Ordering Information <sup>1,2</sup>

Part Number	Package
MASW-009444-TR3000	3000 piece reel
MASW-009444-001SMB	Sample Board

1. Reference Application Note M513 for reel size information.
2. All sample boards include 5 loose parts.

## Absolute Maximum Ratings <sup>3,4</sup>

Parameter	Absolute Maximum
Max Input Power (0.5 - 3 GHz, 2.7V Control)	+27 dBm
Operating Voltage	+8.5 volts
Operating Temperature	-40°C to +85°C
Storage Temperature	-65°C to +150°C

3. Exceeding any one or combination of these limits may cause permanent damage to this device.
4. M/A-COM does not recommend sustained operation near these survivability limits.

\* Restrictions on Hazardous Substances, European Union Directive 2002/95/EC.

**Electrical Specifications:**<sup>5</sup>  $T_A = 25^\circ\text{C}$ ,  $V_C = 1.8\text{ V}$ ,  $Z_0 = 50\ \Omega$

Parameter	Test Conditions	Units	Min.	Typ.	Max.
Insertion Loss	DC - 1 GHz	dB	—	0.2	.45
	1 - 2 GHz		—	0.3	—
	2 - 3 GHz		—	0.4	—
Isolation	DC - 1 GHz	dB	22	28	—
	1 - 2 GHz		—	23	—
	2 - 3 GHz		—	19	—
VSWR	DC - 2.5 GHz	dB	—	<1.3	—
	2.5 - 3 GHz		—	<1.3	—
IP3	Two Tone +10 dBm, 5 MHz Spacing, >50 MHz $P_{IN} = 0\text{ dBm}$ $V_C = 0/2.5\text{ V}$	dBm	—	47	—
P1dB	$V_C = 1.8\text{ V}$	dBm	—	15	—
	$V_C = 2.7\text{ V}$		—	24	—
Trise, Tfall	10% to 90% RF, 90% to 10% RF	ns	—	10	—
Ton, Toff	50% control to 90% RF, and 50% control to 10% RF	ns	—	15	—
Transients	In Band	mV	—	30	—
Control Current	$ V_C  = 1.8\text{ V}$	$\mu\text{A}$	—	5	10

5. Insertion Loss can be optimized by varying the DC Blocking Capacitor value, i.e. 1000 pF for 100 - 500 MHz, 39 pF for 0.5 - 3.0 GHz

## Truth Table <sup>6</sup>

V1	V2	RFC - RF1	RFC - RF2
0 V	+1.8 to 5 V	On	Off
+1.8 to 5 V	0 V	Off	On

6. External DC blocking capacitors are required on all RF ports

## Handling Procedures

Please observe the following precautions to avoid damage:

## Static Sensitivity

Gallium Arsenide Integrated Circuits are sensitive to electrostatic discharge (ESD) and can be damaged by static electricity. Proper ESD control techniques should be used when handling these devices.

## Typical Performance Curves

**Insertion Loss**

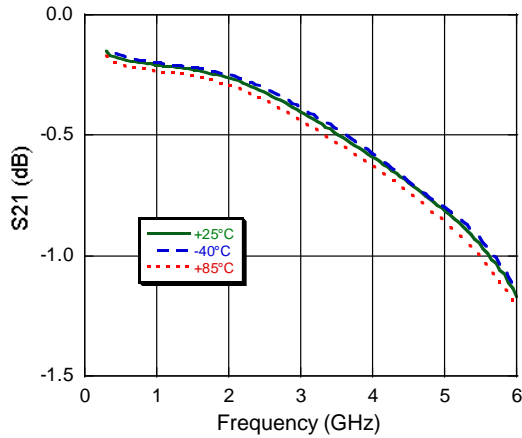

**Isolation**

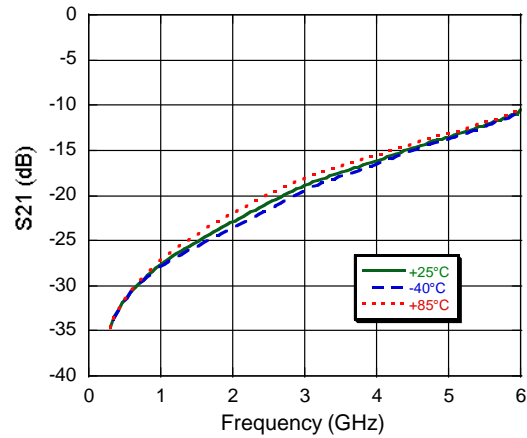

**Input Return Loss**

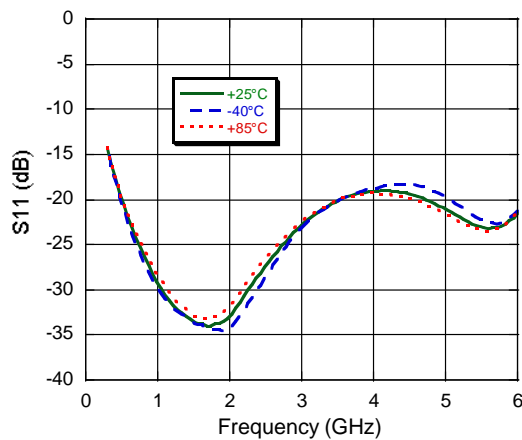

**Output Return Loss**

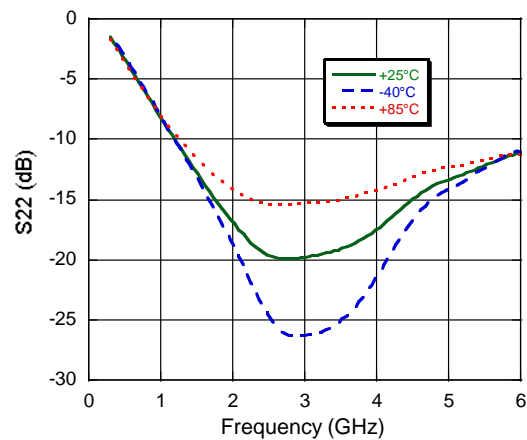

**Input P1dB vs. Control Voltage**

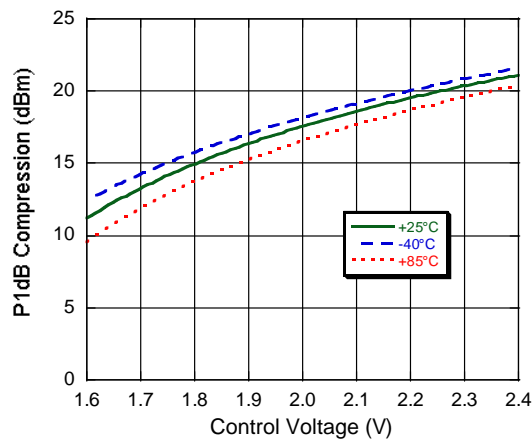

## Lead-Free 1 mm 6-Lead PDFN<sup>†</sup>

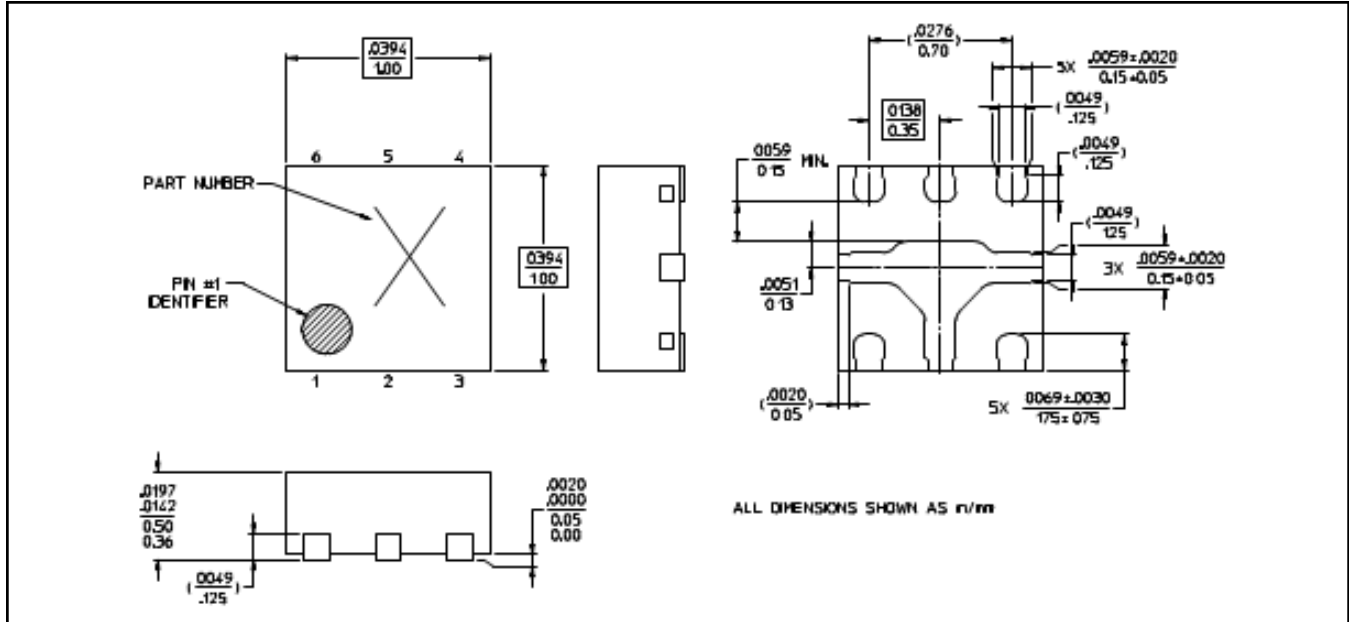

<sup>†</sup> Reference Application Note S2083 for lead-free solder reflow recommendations.  
Meets JEDEC moisture sensitivity level 1 requirements.