



LUXEON XR-3535L

Turnkey solution on a rigid substrate enabling high-efficacy designs

LUXEON XR-3535L is a fully integrated solution optimized for lighting applications requiring LED linear arrays mounted on a rigid and thermally conductive substrate. The turnkey solution minimizes time to market and simplifies supply chain by reducing optical and mechanical design efforts. Combined with LUXEON 3535L, the integrated unit provides the same powerful optical performance guaranteed by LUXEON LEDs. The overall solution delivers optimized performance in combination with the quality of light needed for distributed light source applications.



FEATURES AND BENEFITS

1400–1500 lumen offerings enabling efficacies of up to 152 lm/W

A full range of CCT offerings: 3000–5000K with 80CRI minimum

Complete integrated solution guarantees simplified supply chain and faster time to market

Super CEM3 PCB rigid substrate for mechanical robustness and efficient heat dissipation

Two electrical connector options with snap-together or pushbutton terminal blocks

Zhaga certified mechanical design for easy mounting and assembly

UL-recognized component [E335118]

PRIMARY APPLICATIONS

Indoor Area Lighting

- Troffers

Table of Contents

General Product Information	2
Product Test Conditions	2
Part Number Nomenclature	2
Lumen Maintenance	2
Environmental Compliance	2
Performance Characteristics	3
Product Selection Guide	3
Electrical and Thermal Characteristics	3
Absolute Maximum Ratings	4
Characteristic Curves	5
LED Spectral Distribution Characteristics	5
Radiation Pattern Characteristics	5
Color Bin Definition	6
Mechanical Dimensions	7
L202 – xxxx033C30000	7
L202 – xxxx033C30001	9
Packaging Information	11
Tray Dimensions	11
Assembly Precautions	12
Zhaga Compliance	12
About Lumileds	13

General Product Information

Product Test Conditions

LUXEON 3535L LEDs are tested and binned at 100mA and $T_j=25^{\circ}\text{C}$.

The nominal current for LUXEON XR-3535L is 100mA x the number of parallel LED strings. A LUXEON XR-3535L configuration with 3 parallel strings has a nominal drive current of 300mA.

The LEDs on LUXEON XR-3535L are tested and specified individually at a junction temperature of 25°C with a drive current of 100mA and pulse duration of 20ms. The minimum, typical, and maximum performance numbers for LUXEON XR-3535L in this datasheet are derived from the individual LED measurements. The confidence level on all minimum and maximum performance parameters in this datasheet is 99% to within individual LED tolerance.

Part Number Nomenclature

Part numbers for LUXEON XR-3535L follow the convention below:

L 2 0 2 – **A A B B** 0 3 3 C 3 0 0 0 **D**

Where:

- AA** - designates nominal ANSI CCT (27=2700K, 30=3000K, etc...)
- BB** - designates minimum CRI (80=80CRI)
- D** - designates connector brand/type (0=Molex, snap-together and 1=WAGO, pushbutton)

Therefore, a LUXEON XR-3535L 3000K 80CRI with a WAGO connector will have the following part number:

L 2 0 2 – **3 0 8 0** 0 3 3 C 3 0 0 0 **1**

Lumen Maintenance

Please contact your local Sales Representative or Lumileds Technical Solutions Manager for more information about the long-term performance of this product.

Environmental Compliance

Lumileds is committed to providing environmentally friendly products to the solid-state lighting market. LUXEON LEDs are compliant to the European Union directives on the restriction of hazardous substances in electronics equipment, namely the RoHS directive. Lumileds will not intentionally add the following restricted materials to its products: lead, mercury, cadmium, hexavalent chromium, polybrominated biphenyls (PBB) or polybrominated diphenyl ethers (PBDE).

Performance Characteristics

Product Selection Guide

Table 1. Product performance of LUXEON XR-3535L at 300mA, $T_j=25^\circ\text{C}$ [1].

NOMINAL CCT	MINIMUM CRI [2]	LUMINOUS FLUX [3] (lm)		TYPICAL LUMINOUS EFFICACY (lm/W)	PART NUMBER [4]
		MINIMUM	TYPICAL		
3000K	80	1320	1403	142	L202 - 3080033C3000x
3500K	80	1386	1469	148	L202 - 3580033C3000x
4000K	80	1419	1502	152	L202 - 4080033C3000x
5000K	80	1419	1502	152	L202 - 5080033C3000x

Notes for Table 1:

1. Nominal current is 100mA x 3 parallel strings = 300 mA.
2. Lumileds maintains a tolerance of ± 2 on CRI measurements.
3. Lumileds maintains a tolerance of $\pm 7.5\%$ on flux measurements.
4. "x" is an attribute used to designate connector brand/type. See Part Number Nomenclature.

Electrical and Thermal Characteristics

Table 2. Electrical and thermal characteristics for LUXEON XR-3535L at 100mA, $T_j=25^\circ\text{C}$.

PART NUMBER [6]	FORWARD VOLTAGE (V_f) [1]			TYPICAL TEMPERATURE COEFFICIENT OF FORWARD VOLTAGE ($\text{mV}/^\circ\text{C}$) [2]	TYPICAL THERMAL RESISTANCE JUNCTION TO SOLDER PAD ($^\circ\text{C}/\text{W}$) [3, 4, 5]		
	MINIMUM	TYPICAL	MAXIMUM		$R\theta_{s-B}$	$R\theta_{j-c}$	$R\theta_{j-s}$
L202 - xxxx033C3000x	31.9	33	34.1	-16.5	0.61	1.2	0.55

Notes for Table 2:

1. Lumileds maintains a tolerance of $\pm 0.1\text{V}$ on forward voltage measurements for LUXEON 3535L LEDs.
2. Measured between 25°C and 85°C for coefficient of forward voltage.
3. $R\theta_{j-s}$ specified from LED junction to temperature measurement point (T_j) next to LED. See Application Brief AB203 for details.
4. $R\theta_{s-B}$ specified from temperature measurement point (T_j) next to LED, to bottom of PCB (heat sink).
5. $R\theta_{j-c}$ specified from LED junction to T_c (thermal contact point) on top of PCB.

Absolute Maximum Ratings

Table 3. Absolute maximum ratings for LUXEON XR-3535L.

PARAMETER	MAXIMUM PERFORMANCE	
	L202 – xxxx033C30000	L202 – xxxx033C30001
DC Forward Current ^[1]	425mA	600mA
Peak Pulsed Forward Current ^[2]	545mA	720mA
LED Junction Temperature ^[3] (DC & Pulse)	125°C	
ESD Sensitivity ^[4]	IEC 61000-4-2 Level 4 (8/15 kV contact/air discharge)	
Operating Case Temperature ^[5]	-40°C to 85°C	
Storage Temperature	<30°C, <80%RH, ≤1 year	
CEM3 Substrate ^[6]	130°C	
Reverse Voltage ($V_{reverse}$) ^[7, 8]	-5V x Number of series LEDs	
UL Recognition ^[9]	UL recognized for Class 2 drivers. Substrate and white reflective coating UL94 V0 flammability rated	

Notes for Table 3:

1. Ripple current with a frequency of 50-150Hz is allowed, as long as the average of the current waveform is below 200mA/LED, and the maximum of the current waveform is lower than 240mA/LED.
2. At 10% duty cycle and pulse width 10ms.
3. Proper current de-rating must be observed to maintain junction temperature below the maximum.
4. It is recommended that the LUXEON XR-3535L always be handled/assembled in an ESD safe environment. Handle board around edges and avoid touching the LEDs or exposed metals directly.
5. TC thermal contact point on top of PCB.
6. As per UL746 rating.
7. LUXEON 3535L LEDs are not designed to be driven in reverse bias
8. At maximum reverse current of 10µA/LED.
9. UL Efile number: E335118.

Characteristic Curves

LED Spectral Distribution Characteristics

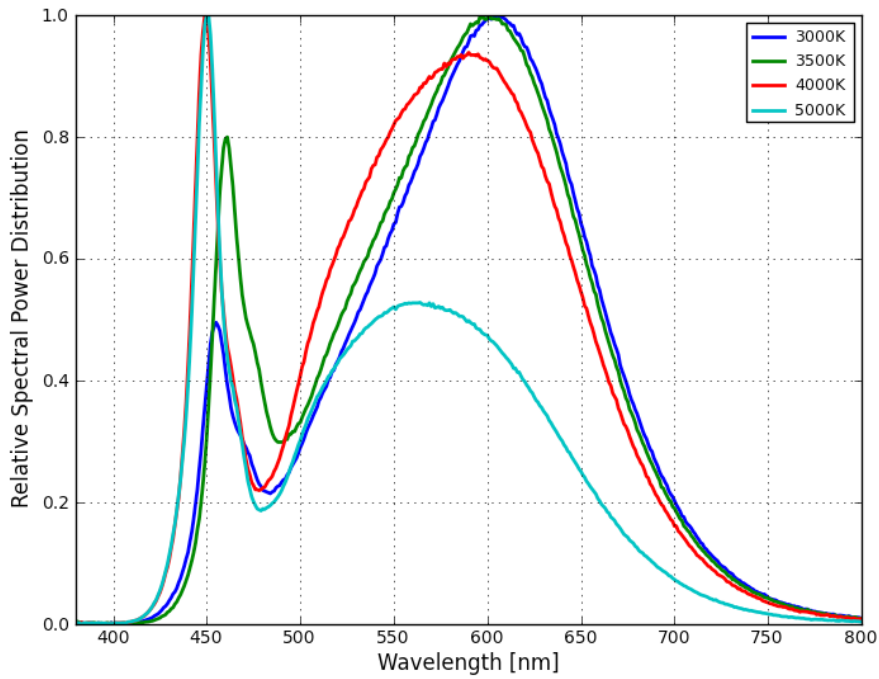

Figure 1: Typical normalized power vs. wavelength for LUXEON 3535L LEDs at 100mA, $T_j=25^\circ\text{C}$.

Radiation Pattern Characteristics

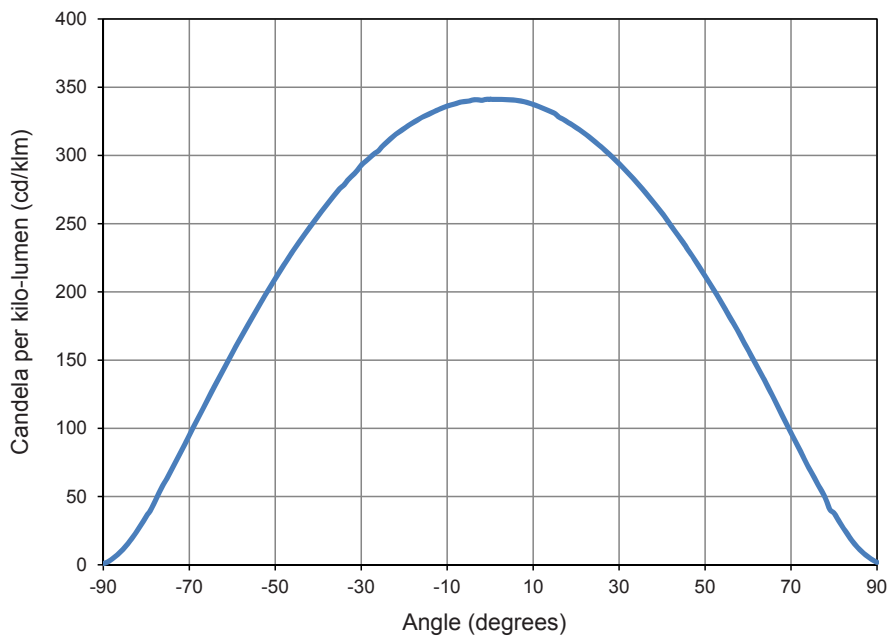

Figure 2: Typical radiation pattern for L202 - xxxx033C3000x at 300mA, $T_j=25^\circ\text{C}$.

Color Bin Definition

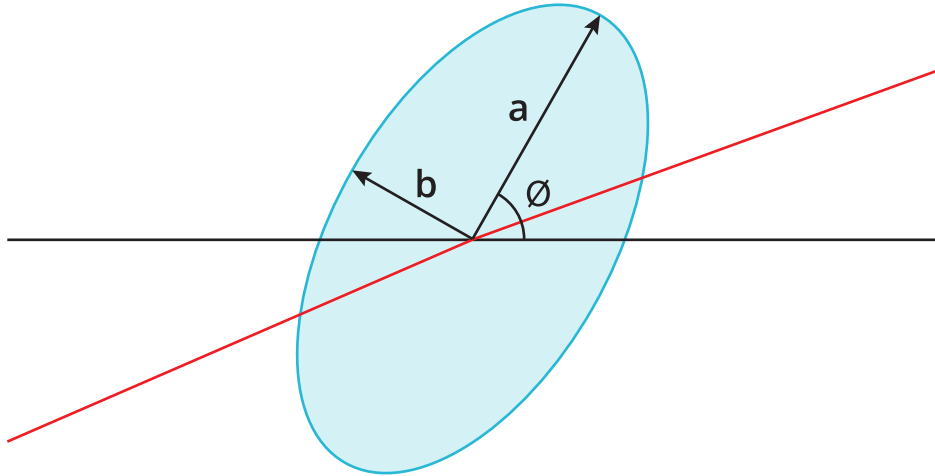

Figure 3: 3-step MacAdam ellipse illustration for Table 4.

Table 4. 3-step MacAdam ellipse color bin definitions for LUXEON XR-3535L.

NOMINAL CCT	COLOR SPACE	CENTER POINT (cx, cy)	MAJOR AXIS, a	MINOR AXIS, b	ELLIPSE ROTATION ANGLE, θ
3000K	Single 3-step MacAdam ellipse	(0.4338, 0.4030)	0.00834	0.00408	53.2°
3500K	Single 3-step MacAdam ellipse	(0.4073, 0.3917)	0.00927	0.00414	54.0°
4000K	Single 3-step MacAdam ellipse	(0.3818, 0.3797)	0.00939	0.00402	53.7°
5000K	Single 3-step MacAdam ellipse	(0.3447, 0.3553)	0.00822	0.00354	59.6°

Notes for Table 4:

1. Lumileds maintains a tolerance of ± 0.01 on x and y color coordinates in the CIE 1931 color space.

Mechanical Dimensions

L202 - xxxx033C30000

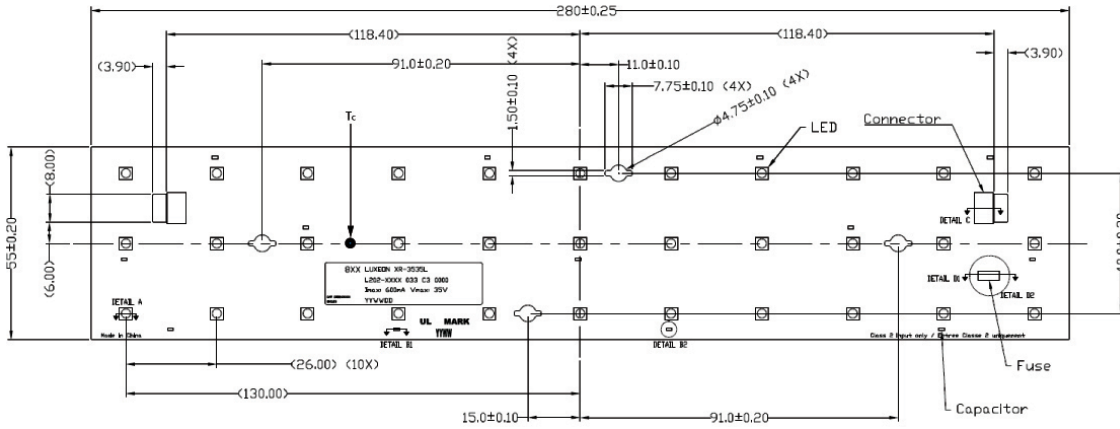

Figure 4: Mechanical dimensions for L202 - xxxx033C30000, outline, screw hole and LED pitch.

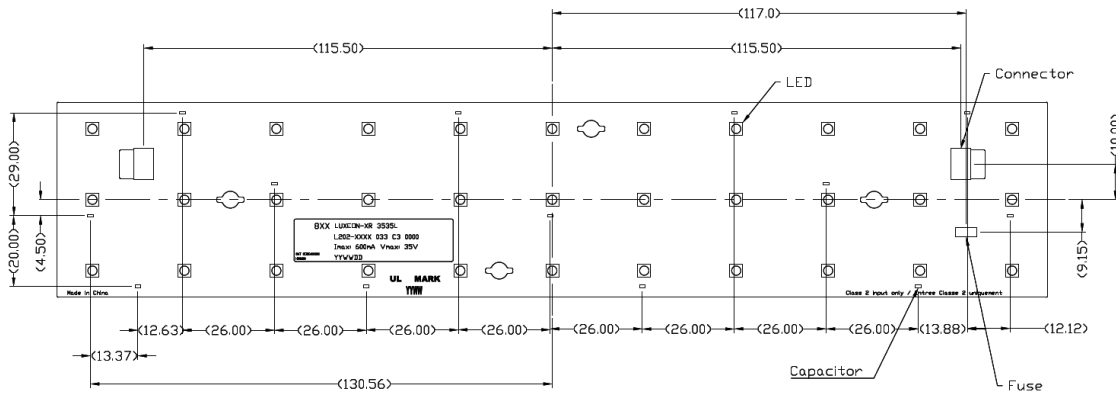

Figure 5: Mechanical dimensions for L202 - xxxx033C30000, component locations.

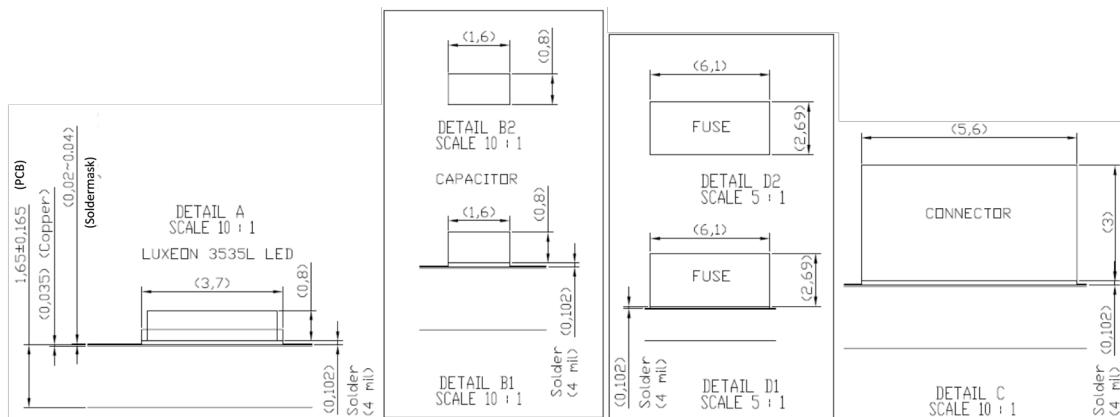

Figure 6: Mechanical dimensions for L202 - xxxx033C30000, component profiles.

- Notes for Figures 4, 5 and 6:
1. Drawings are not to scale.
 2. All dimensions are in millimeters.

Tolerances unless otherwise specified		
	Linear (mm)	Angular
XX.	± 0.30	± 1°
XX.X	± 0.20	± 0°30'
XX.XX	± 0.10	± 0°00'30"

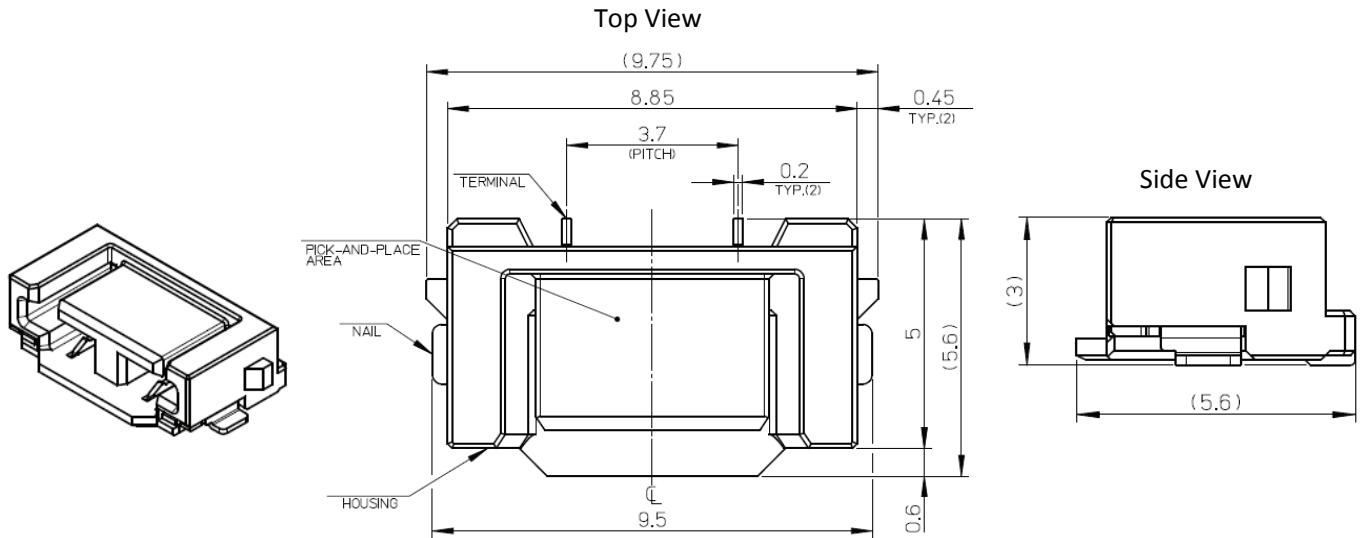

Figure 7: Mechanical dimensions for Molex (snap-together) connectors for L202 - xxxx033C30000.

Notes for Figure 7:

1. Drawings are not to scale.
2. All dimensions are in millimeters.
3. Mates with: Molex 503469-xxxx OR 503473-xxxx.

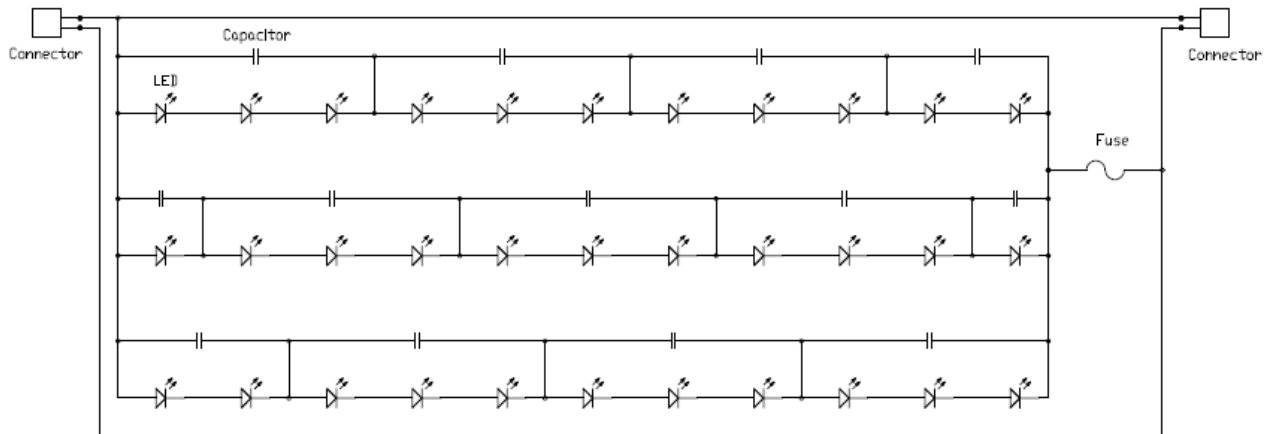

Figure 8: Electrical circuit diagram for L202 - xxxx033C30000.

Notes for Figure 8:

1. Drawings are not to scale.
2. All dimensions are in millimeters.

Table 5. Bill of materials for L202 - xxxx033C3000.

NUMBER	COMPONENT DESCRIPTION	QUANTITY
1	LED: LUXEON 3535L	33
2	Connector: Molex 503471-0290	2
3	Fuse: 125V max, 630mA	1
4	Capacitor: 100nF, X7R, 0603, 50V	13

L202 - xxxx033C30001

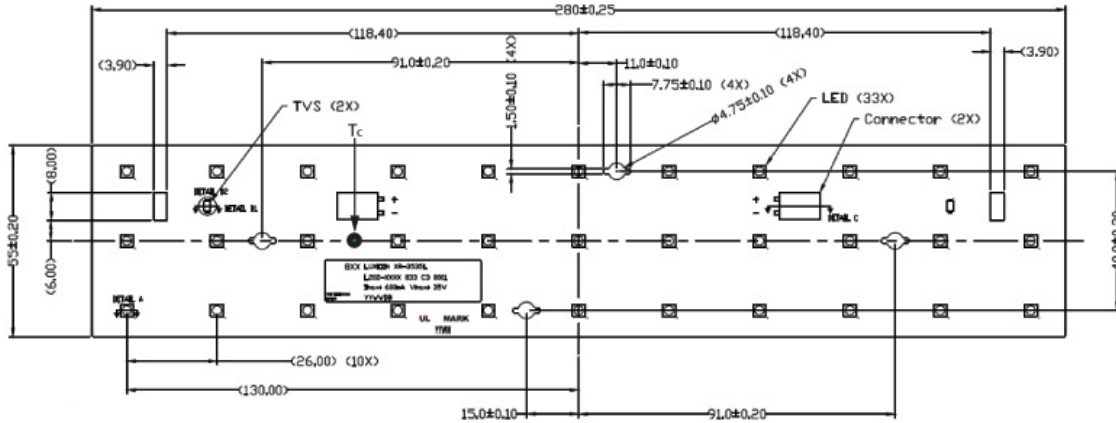

Figure 9: Mechanical dimensions for L202 - xxxx033C30001, outline, screw hole and LED pitch.

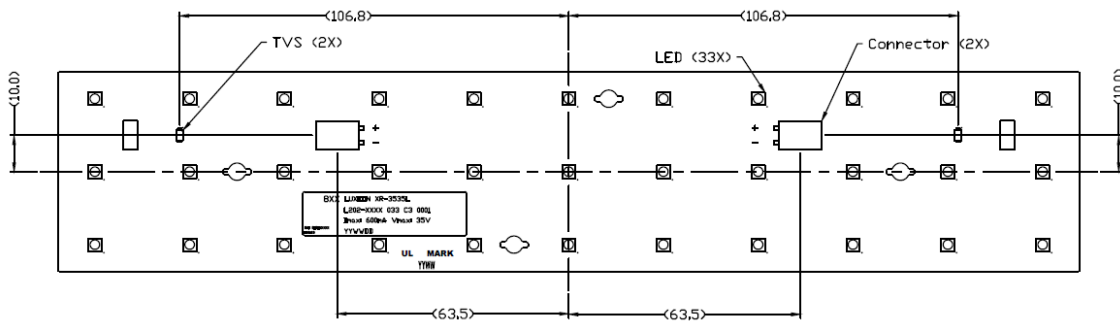

Figure 10: Mechanical dimensions for L202 - xxxx033C30001, component locations.

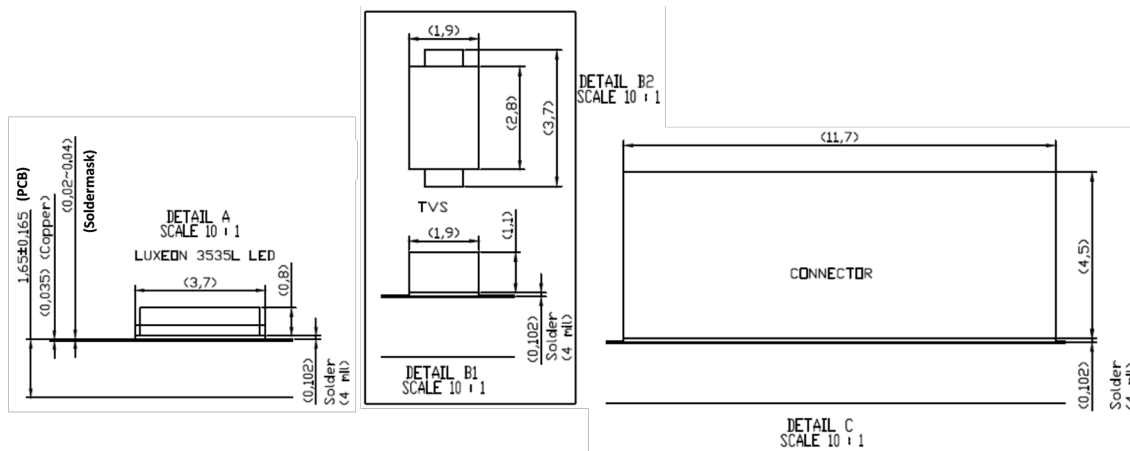

Figure 11: Mechanical dimensions for L202 - xxxx033C30001, component profiles.

- Notes for Figures 9, 10 and 11:
1. Drawings are not to scale.
 2. All dimensions are in millimeters.

Tolerances unless otherwise specified		
	Linear (mm)	Angular
XX.	± 0.30	± 1°
XX.X	± 0.20	± 0°30'
XX.XX	± 0.10	± 0°00'30"

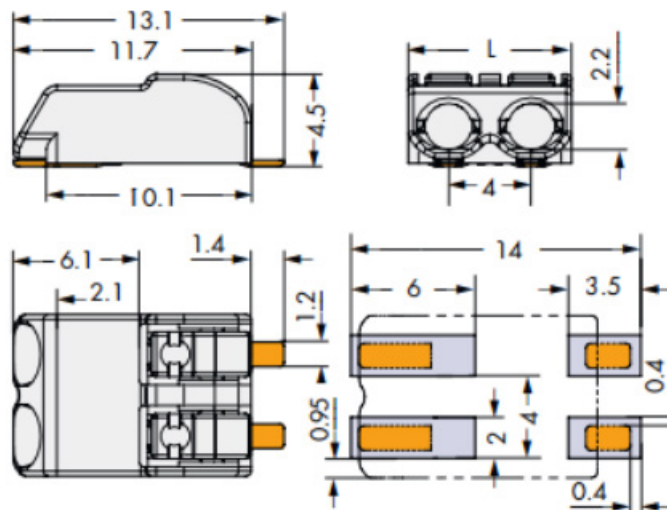

Figure 12: Mechanical dimensions for WAGO (pushbutton) connectors for L202 – xxxx033C30001.

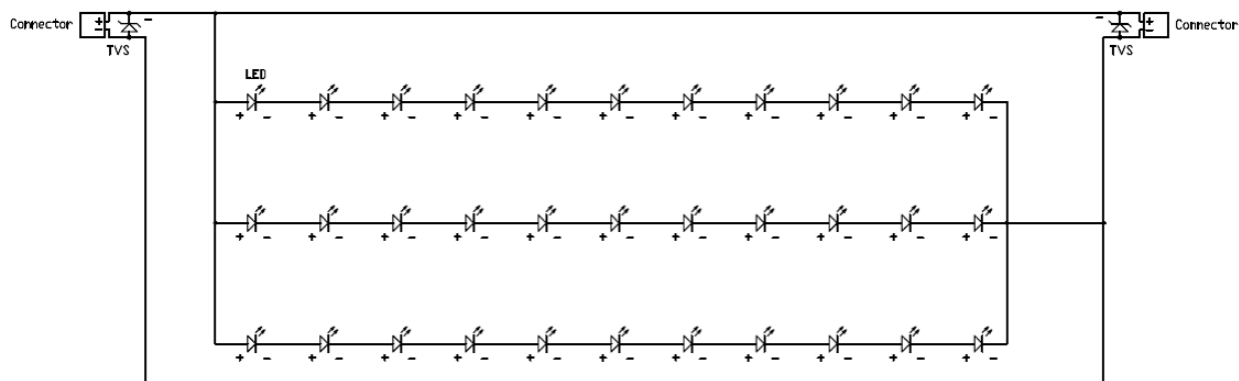

Figure 13: Electrical circuit diagram for L202 – xxxx033C30001.

Notes for Figures 12 and 13:
 1. Drawings are not to scale.
 2. All dimensions are in millimeters.

Table 6. Bill of materials for L202 – xxxx033C30001.

NUMBER	COMPONENT DESCRIPTION	QUANTITY
1	LED: LUXEON 3535L	33
2	Connector: WAGO 2060-402/998-404	2
3	Diode: 400W, SOD123W	2

Packaging Information

Tray Dimensions

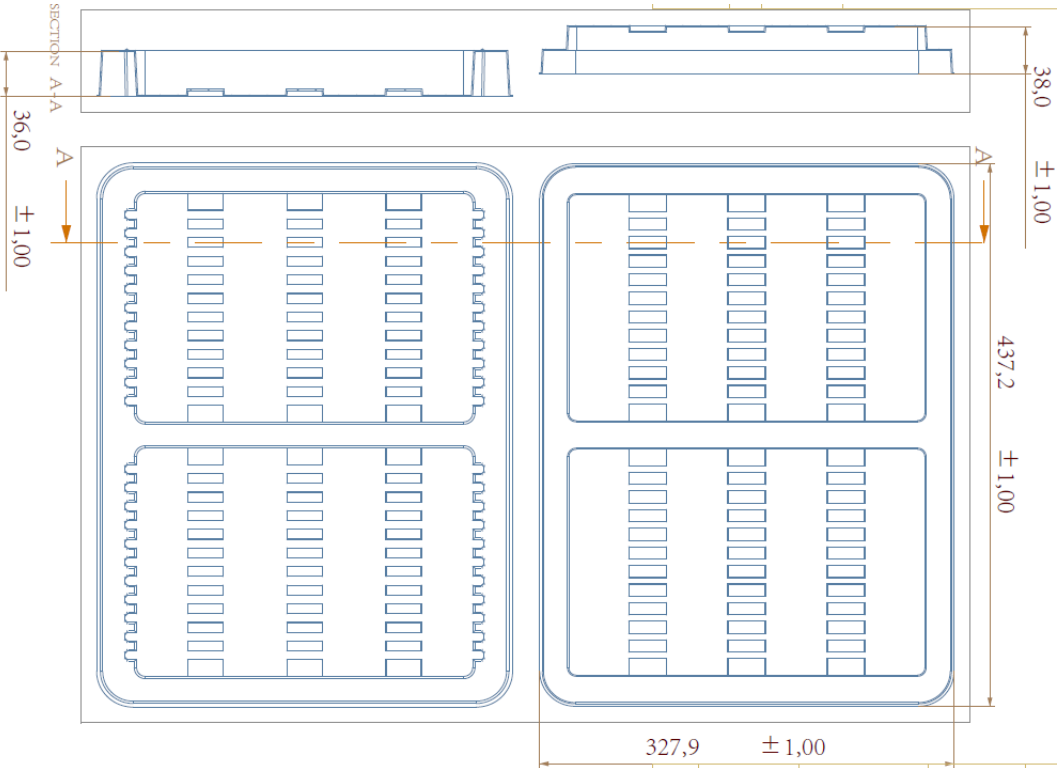

Figure 14: Tray dimensions for LUXEON XR-3535L.

- Notes for Figure 14:
- 1. Drawings are not to scale.
 - 2. All dimensions are in millimeters.
 - 3. Height with PCB inside is 56.7 ±1.0mm.
 - 4. Each tray fits 44 boards placed back to back.

Assembly Precautions

The LUXEON 3535L emitter package contains a silicone overcoat to protect the LED chip and extract the maximum amount of light. As with most silicones used in LED optics, care must be taken to prevent any incompatible chemicals from directly or indirectly reacting with the silicone.

The silicone overcoat used in the LUXEON emitter is gas permeable. Consequently, oxygen and volatile organic compound (VOC) gas molecules can diffuse into the silicone overcoat. VOCs may originate from adhesives, solder fluxes, conformal coating materials, potting materials and even some of the inks that are used to print the PCBs.

Some VOCs and chemicals react with silicone and produce discoloration and surface damage. Other VOCs do not chemically react with the silicone material directly but diffuse into the silicone and oxidize during the presence of heat or light. Regardless of the physical mechanism, both cases may affect the total LED light output. Since silicone permeability increases with temperature, more VOCs may diffuse into and/or evaporate out from the silicone.

Please refer to Application Brief AB203 for more details on VOCs and other incompatible chemicals.

It is recommended that LUXEON XR-3535L always be handled/assembled in an ESD safe environment. Handle board around edges and avoid touching LEDs or exposed metals directly. LUXEON XF-3535L is designed for operation within maximum boundaries as described in this datasheet. Operation outside of maximum ratings may result in LED failure and induce light output loss or uncontrolled failure modes. If multiple products are connected in parallel, failure of one module may result in excessive current in remaining modules. Make sure wires are connected in the correct polarity and use only recommended wire gauge (18-24 AWG).

Zhaga Compliance

Table 7. Zhaga compliance information for LUXEON XR-3535L.

Designation of the ECG housing (book-1 / annex C)	NA
Designation of the Book-7 LLE category	L28W6
Luminous Flux Category at $t_{p,max}$	C020
CCT category at $t_{p,max}$	3000, 3500, 4000, 5000 K
CRI at $t_{p,max}$	80
CCT/CRI codes per IEC 62732	830, 835, 840, 850
Position of temperature measurement point t_p	Same as T_c point
Value of $t_{p,max}$	85°C
Value of $t_{p, headroom}$	30°C
Number of LED modules in LLE	1



About Lumileds

Lumileds is the light engine leader, delivering innovation, quality and reliability.

For 100 years, Lumileds commitment to innovation has helped customers pioneer breakthrough products in the automotive, consumer and illumination markets.

Lumileds is shaping the future of light with our LEDs and automotive lamps, and helping our customers illuminate how people see the world around them.

To learn more about our portfolio of light engines, visit lumileds.com.



©2015 Lumileds Holding B.V. All rights reserved.
LUXEON is a registered trademark of the Lumileds Holding B.V.
in the United States and other countries.

lumileds.com

Neither Lumileds Holding B.V. nor its affiliates shall be liable for any kind of loss of data or any other damages, direct, indirect or consequential, resulting from the use of the provided information and data. Although Lumileds Holding B.V. and/or its affiliates have attempted to provide the most accurate information and data, the materials and services information and data are provided "as is," and neither Lumileds Holding B.V. nor its affiliates warrants or guarantees the contents and correctness of the provided information and data. Lumileds Holding B.V. and its affiliates reserve the right to make changes without notice. You as user agree to this disclaimer and user agreement with the download or use of the provided materials, information and data.