

Comprehensive Selection Guide

THERMAL CLAD



Index

THERMAL CLAD

THERMAL CLAD Overview	2-3
THERMAL CLAD Applications	4
THERMAL CLAD Reliability.....	5

Dielectrics

Selecting Dielectric Materials.....	6-7
Dielectric Performance Considerations	8
Summary Of Key Dielectric Characteristics.....	9
Advanced Circuit Processing	10-11

Design Considerations

Baseplate Design Considerations.....	12-13
Selecting A Circuit Layer.....	14-15
Electrical Design Considerations.....	16-17
Assembly Recommendations.....	18-19

Other BERGQUIST Thermal Products..... 20-21

Appendix..... 22

THERMAL CLAD Configurations..... 23

Henkel. Developing solutions for the electronics industry.

Proven thermal management solutions and problem-solving partnership.

We make it our business to know your business. We understand your problems. We also know that there will always be a better way to help you reach your goals and objectives. To that end, our company continually invests considerable time and money into research and development.

Henkel is in the business of solving problems. With our history and experience in the electronics industry, our experts can help find ways to improve your process, control and manage heat, and back it all with exceptional service.

Let us show you the value Henkel offers.



THERMAL MANAGEMENT LEADER

Our solutions to control and manage heat in electronic assemblies and printed circuit boards are used by many of the world's largest OEMs in a wide range of industries



GLOBAL SUPPORT

with locations in North America, Asia and Europe, and sales staff in 30 countries



INNOVATION

Henkel's BERGQUIST thermal solutions were often developed for specific customer requests

WHY Henkel?

Henkel, the leading solution provider for adhesives, sealants and functional coatings worldwide, uses high-quality BERGQUIST thermal management products—like BERGQUIST TCLAD, BERGQUIST SIL-PAD and BERGQUIST LIQUI-BOND—to offer technological solutions for electronics. Beyond that, we work closely with our customers to understand your problems and deliver technologically advanced solutions backed by exceptional service.



GLOBAL SUPPLY CHAIN

to maintain a reliable supply of products to our customers



BROAD PRODUCT PORTFOLIO

that includes LOCTITE, TECHNOMELT and BERGQUIST products



R&D

Over 10 R&D Centers around the world staffed by 3,000 design and application professionals

THERMAL CLAD Overview

Key Benefits Of THERMAL CLAD

Henkel is the world leader in the development and manufacture of thermally conductive interface materials. THERMAL CLAD Insulated Metal Substrate (IMS®) was developed by Henkel as a thermal management solution for today's higher watt-density surface mount applications where heat issues are a major concern.

THERMAL CLAD substrates minimize thermal impedance and conduct heat more effectively and efficiently than standard printed wiring boards (PWB's). These substrates are more mechanically robust than thick-film ceramics and direct bond copper constructions that are often used in these applications.

THERMAL CLAD is a cost-effective solution which can eliminate components, allow for simplified designs, smaller devices and an overall less complicated production processes. Additional benefits of THERMAL CLAD include lower operating temperatures, longer component life and increased durability.

Henkel's BERGQUIST brand THERMAL CLAD substrates are not limited to use with metal base layers. In one example, power conversion applications can enhance their performance by replacing FR-4 with THERMAL CLAD dielectrics in multi-layer assemblies. In this application, the thickness of the copper circuit layer can be minimized by the high thermal performance of THERMAL CLAD. For additional information on this topic, refer to the "Specialty Applications" section on pages 12-13 of this guide.



Traditionally, cooling an FR-4 board required use of a large heat sink, interface material and various hardware (brackets, screws or clamps); a configuration requiring labor intensive manual assembly.

Cooling with THERMAL CLAD can eliminate the need for heat sinks, device clips, cooling fans and other hardware. An automated assembly method will reduce long term costs.



Conventional methods measured junction temperature 5W=Tj 43°C



THERMAL CLAD measured junction temperature 5W=Tj 35°C

Original Power Board Assembly (Actual)

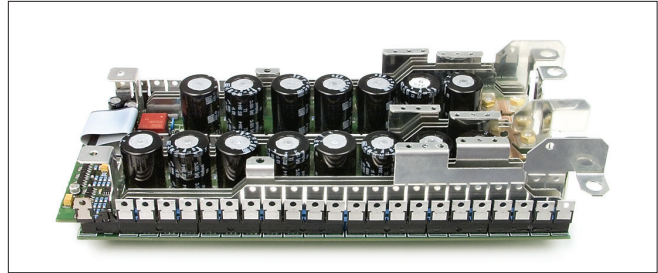

(66) Thru-hole FETs (15) High profile capacitors (9) High profile bus bars
Total Weight 3.4 lbs (1543.6 g)

New Power Board Assembly (Actual)

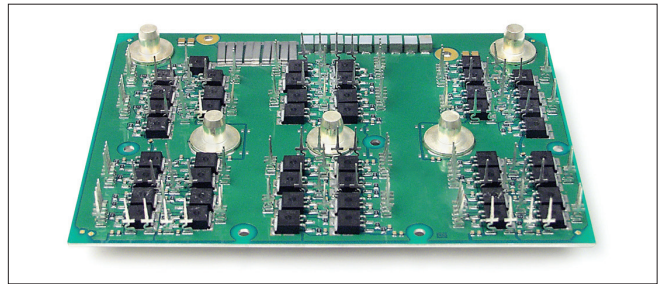

(48) FETs (9) Low profile capacitors (5) Low profile bus bars
Total Weight 0.82 lbs (370.6 g)

THERMAL CLAD is a complete thermal management system, unlike traditional technology which uses heat sinks, clips and other mounting hardware. THERMAL CLAD enables low-cost production by eliminating the need for costly manual assembly.

THERMAL CLAD Benefits

- RoHS and Reach compliant and halogen-free
- Lower component operating temperatures
- Reduce printed circuit board size
- Increase power density
- Extend the life of dies
- Reduce the number of interconnects
- Improve product thermal and mechanical performance
- Combine power and control
- Improve product durability
- Enable better use of surface mount technology
- Reduce heat sinks and other mounting hardware, including thermal interface material
- Replace fragile ceramic substrates with greater mechanical durability
- Henkel is your one-stop source from raw materials to finished circuit boards

Improve Durability and Performance

THERMAL CLAD improves durability because designs can be kept simple while components are kept cool. The low thermal impedance of the THERMAL CLAD dielectric outperforms other insulators for power components, allowing for cooler operation.

THERMAL CLAD keeps assemblies cool by eliminating thermal interfaces and using thermally efficient solder joints. Voltage breakdown and thermal performance improve in potted assemblies using SMD's and bare die on THERMAL CLAD.

THERMAL CLAD can also reduce production costs by enabling automated pick-and-place equipment for SMD's.

Reduce Board Size and Replace Hardware

THERMAL CLAD greatly reduces board space while replacing other components including heat sinks. It offers the opportunity to eliminate mica and grease or rubber insulators under power devices by using direct solder mount to THERMAL CLAD. By eliminating this hardware, heat transfer is improved.

Interconnects can be eliminated by using etched traces on the THERMAL CLAD board. In fact, whole sections of PWB's are often eliminated. It permits the use of surface mount power and passive devices to reduce real estate. With THERMAL CLAD, many discrete devices can be replaced at the board level.

The Anatomy Of A THERMAL CLAD Board

THERMAL CLAD is a dielectric (ceramic-polymer blend) coated metal base with a bonded copper circuit layer. This unique material offers superior heat transfer to help cool components while eliminating the problems associated with fragile ceramics. Different than others, Henkel's BERGQUIST brand doesn't use fiberglass, allowing for better thermal performance.

THERMAL CLAD is a three layer system comprised of the following:

- **Circuit Layer:** This is the printed circuit foil with a thickness range of .5oz. to 10oz. (17-350 μ m) in standard THERMAL CLAD.
- **Dielectric Layer:** This offers electrical isolation with minimum thermal resistance. Glass carriers degrade thermal performance which is why our dielectrics are glass-free. CML is the one exception because of its prepreg form, a glass carrier is needed for handling purposes. The dielectric layer is the key element of THERMAL CLAD, and bonds the base metal and circuit metal together. The dielectric has UL recognition, simplifying agency acceptance of final assemblies.
- **Base Layer:** This is often aluminum, but other metals such as copper may also be used. The most widely used base material thickness is 0.062" (1.57mm) in aluminum, although many thicknesses are available. In some applications, the base layer of metal may not be needed. See "Advanced Circuit Processing" on page 12.

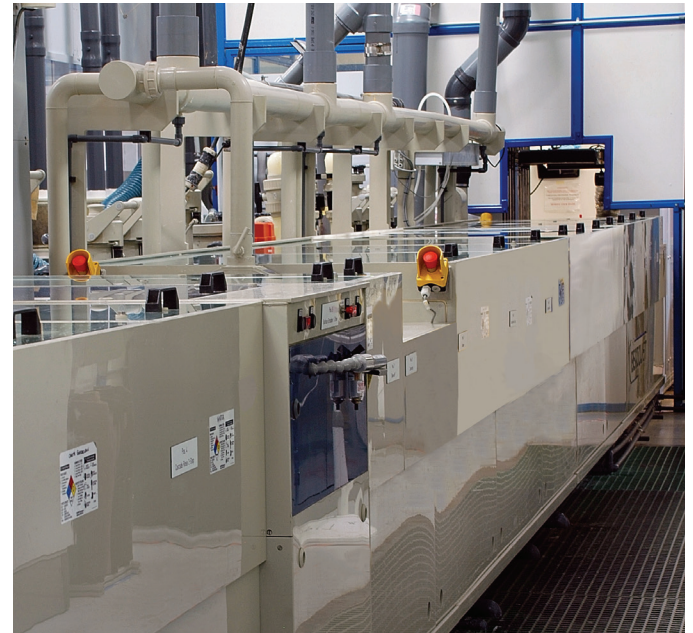

Henkel's BERGQUIST manufacturing facility located in Prescott, Wisconsin features state-of-the-art process capabilities. Process manufacturing uses the latest in technology including environmental clean room control, surface finishing, coating and lamination.

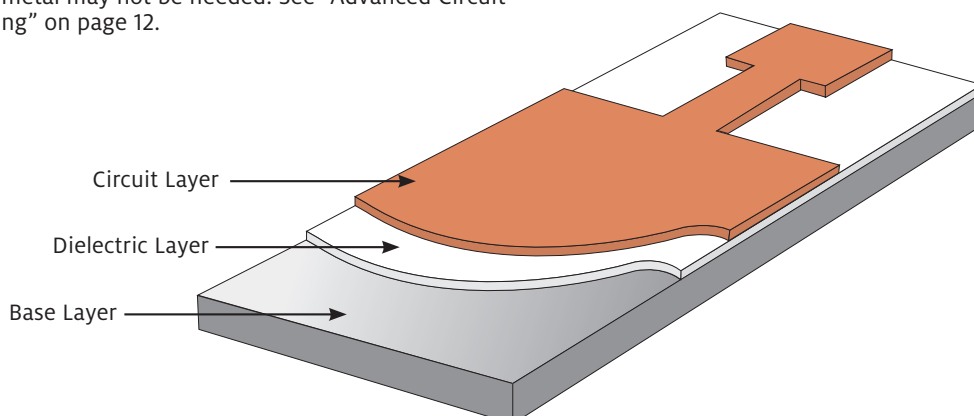

THERMAL CLAD Applications

Power Conversion

Due to the size constraints and watt-density requirements in DC-DC conversion, THERMAL CLAD has become the favored choice. THERMAL CLAD is available in a variety of thermal performances, is compatible with mechanical fasteners and is highly reliable. It can be used in almost every form-factor and fabricated in a wide variety of substrate metals, thicknesses and copper foil weights.



Heat-Rail And Forming

The use of THERMAL CLAD in heat-rail applications has increased significantly and is currently used in automotive, audio, motor control and power conversion applications. THERMAL CLAD offers many advantages including surface mount assembly, attachment capabilities and excellent thermal performance. The dielectric can be selectively removed and the metal can be formed with three-dimensional features making THERMAL CLAD a versatile substrate.



Solid State Relays/Switches

The implementation of Solid State Relays in many control applications calls for thermally efficient, and mechanically robust substrates. THERMAL CLAD offers both. The material construction allows mounting configurations not reasonably possible with ceramic substrates. New dielectrics meet the high thermal performance expectations and can even out-perform existing ceramic based designs.



Motor Drives

Compact high-reliability motor drives built on THERMAL CLAD have set the benchmark for watt-density. Dielectric choices provide the electrical isolation necessary to meet operating parameters and safety agency test requirements. With the ability to fabricate in a wide variety of form-factors, implementation into either compact or integrated motor drives is realized. The availability of THERMAL CLAD HT makes high temperature operation possible.



LEDs

In Power LED applications, light output and long life are directly attributable to how well the LED's are managed thermally. THERMAL CLAD is an excellent solution for designers. T-Clad is a metal based material (often referred to as a MCPCB), and can be configured for special shapes, bends and thicknesses thus allowing the designer to put LED light engines in virtually any application. Mounting Power LED's on T-Clad assures the lowest possible operating temperatures and maximum brightness, color and life.



*Want to maximize
the lifecycle and color
consistency of your LEDs?*

*Henkel's Thermal Management for
LED Applications Solutions Guide
addresses important factors and
recommendations for selecting a
thermal management solution
ideal for your LED design.*



THERMAL CLAD Reliability

THERMAL CLAD Long Term Reliability

New materials undergo a rigorous 12 to 18 month qualification program prior to being released to the market.

In state-of-the-art laboratories and test facilities, Henkel performs extensive testing on all their thermal materials for electrical integrity. Henkel utilizes stringent development procedures. The lab facilities at Henkel are UL certified and manufacturing facilities are ISO 9001:2008 certified.

Extensive qualification testing consists of mechanical property validation, adhesion, temperature cycling, thermal and electrical stress. To validate long term reliability, electrical testing is performed at selected intervals to 2,000 hours where final evaluation is completed.

To ensure consistent product performance with manufactured materials, we couple the up-front qualification test with regular audits. Audits include physical, electrical and thermal property tests.

Typical Qualification Programs						
Physical Properties	Electrical Properties				Other Properties Evaluated	
Peel Adhesion Pull Strength Sequential Aging	Breakdown Voltage DC and AC Sequential Aging	Insulation Impedance Temp/Hum/Bias 85°C/85%RH/100V 2000 hours	Permittivity/Dissipation Temp/Hum/Bias 85°C/85%RH/100V 2000 hours	Thermal Shock Sand Bath 300°C/1 minute and 200°C/72 hour post	Ten Cycle Solder Shock	
Thermal Stress 230°C/10 min.	Thermal Stress Flammability 230°C/10 min.	Thermal Bias Aging 125°C/100V/2000h	Thermal Bias Aging 125°C/100V/2000h	Thermal Conductivity	Flammability	
Thermal Aging 125°C/2000 hours	Thermal Aging 125°C/2000 hours	Thermal Bias Aging 125°C/480V/2000h	Thermal Bias Aging 125°C/480V/2000h			
Temp Cycling 500 cycles/-40°C-150°C 350 hours	Temp Cycling 500 cycles/-40°C-150°C 350 hours	Thermal Bias Aging 175°C/100V/2000h	Thermal Bias Aging 175°C/100V/2000h			
Temp/Hum/Bias 85°C/85%RH/100V 2000 hours	Temp/Hum/Bias 85°C/85%RH/100V 2000 hours					
Chemical Soak Lonicoterge - 15 min. Alcohol - 15 min.	Chemical Soak Lonicoterge - 15 min. Alcohol - 15 min.					



Dynamic Mechanical Analysis (DMA) – Measures the modulus of materials over a range of temperatures.



Chamber Ovens – Over 3000 cubic feet (85 cubic meters) of oven capacity is dedicated to long term thermal bias age testing. The ovens take material to temperatures above T_g. At selected intervals, samples are removed and tested to verify material integrity.



Thermogravimetric Analyzer (TGA) – Measures the stability of our dielectrics at high temperatures, baking the materials at prescribed temperatures and measuring weight loss.

Selecting Dielectric Materials

Dielectric Layer

The technology of THERMAL CLAD resides in the dielectric layer. It is the key element for optimizing performance in your application. The dielectric is a proprietary polymer/ceramic blend that gives THERMAL CLAD its excellent electrical isolation properties and low thermal impedance.

The polymer is chosen for its electrical isolation properties, ability to resist thermal aging and high bond strengths. The ceramic filler enhances thermal conductivity and maintains high dielectric strength. The result is a layer of isolation which can maintain these properties even at 0.0015" (38µm) thickness. Contact a Henkel Sales Representative for thinner dielectric information. We will help you select the best dielectric to suit your needs for watt-density, electrical isolation and operating temperature environment.

Standardized Methods For Measuring Thermal Conductivity

There are several different test methods for determining a material's thermal conductivity value. Results can be different depending on the method chosen, so it is important to use similar test methods in material comparisons. See chart at right.

Standard test methods include ASTM D5470 and ASTM E1461. ASTM D5470 is a steady state method and is referred to as the guarded hot plate. This method provides an analytically derived value and does not use approximations. ASTM E1461 is a transient method referred to as Laser Flash Diffusivity. In E1461, thermal diffusivity is the test output and thermal conductivity is calculated.

Non-Standard In-House Test Methods

The adjacent chart shows how vastly different thermal conductivity values can be achieved by using "in-house" or non-standard test methods. For example, when the same dielectric is chosen we can derive a completely different and much higher thermal conductivity value by testing a stack-up or laminate with base layer. We can modify the test further by using different materials for the substrate to obtain even higher results. Although thermal conductivity values are still relative to one another so a comparison can be made, these test methods do not give us an accurate depiction of true thermal performance in the application. Included in the chart is a modeled value for thermal conductivity, a respected model for predicting the effective thermal conductivity of anisotropic particulate composites, but not helpful for determining thermal performance in application. We emphasize using standard test methods such as ASTM D5470 and ASTM E1461, which are universally accepted and repeatable.

Note: The hot disk method is not a method we use for comparison because typically this method measures the conductivity of the dielectric alone, which neglects thermal interfacial resistance between layers and carrier holding the dielectric. These values must be understood in order to calculate the actual thermal impedance or thermal performance data. See section regarding thermal impedance on page 9.

Thermal Conductivity

Thermal conductivity is relevant to the application's thermal performance when the thickness of the dielectric material, interfacial resistance and area are taken into consideration. See "Thermal Impedance" section for more information, as this data will be the most relevant to your application.

Lower Thermal Performance
CML - Circuit Material Laminate
HR T30.20
MP - Multi-Purpose
HT - High Temperature
HPL - High Power Lighting
Higher Thermal Performance

Standardized Test Methods (W/m-K)		
PART NUMBER	ASTM D5470 ¹	ASTM E1461 ²
HPL-03015	3.0	3.3
HT-04503	2.2	2.0
HT-07006	2.2	2.0
MP-06503	1.3	1.2
HR T30.20	1.0	1.1

Method Description
 1 - ASTM D5470 Guarded Hot Plate
 2 - ASTM E1461 Laser Flash Diffusivity

Non-Standard Thermal Conductivity Test Methods and Model (W/m-K)					
PART NUMBER	MODEL ¹	GUARDED HOT PLATE LAMINATE ²	GUARDED HOT PLATE LAMINATE ³	LASER FLASH LAMINATE ²	LASER FLASH LAMINATE ³
HT-04503	9.0	32.2	36.4	67.6	115
HT-07006	9.0	21.5	23.3	46.0	86.5
MP-06503	4.5	14.0	24.0	34.9	102

Method Description
 1 - Bruggeman Model
 2 - Tested with 0.062" (1.57mm) 5052 aluminum substrate and 2 oz. (70µm) copper foil
 3 - Tested with 0.062" (1.57mm) 1100 copper substrate and 2 oz. (70µm) foil

Electrical Isolation - Power Applications

Dielectrics are available in thicknesses from 0.0015" (38µm) to 0.009" (229µm), depending on your isolation needs. See "Electrical Design Considerations" on pages 18-19 to help determine which thickness is appropriate for your application.



High Power Lighting Applications

HPL is a dielectric specifically formulated for high power lighting LED applications with demanding thermal performance requirements. This thin dielectric at 0.0015" (38µm) has an ability to withstand high temperatures with a glass transition of 185°C and phenomenal thermal performance of 0.30°C/W. For detailed information, call Henkel Sales or go online.

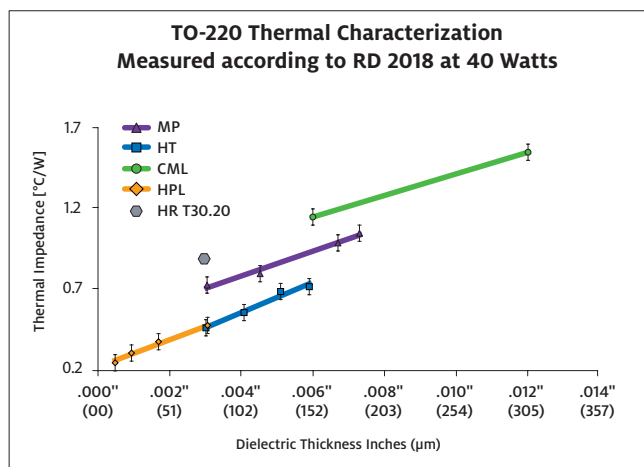

Thermal Impedance Determines Watt Density

Thermal impedance is the only measurement that matters in determining the watt density capability of your application because it measures the temperature drop across the stack-up for each watt of heat flow. Lower thermal impedance results in lower junction temperatures. The lower the thermal impedance, the more efficiently heat travels out of the components.

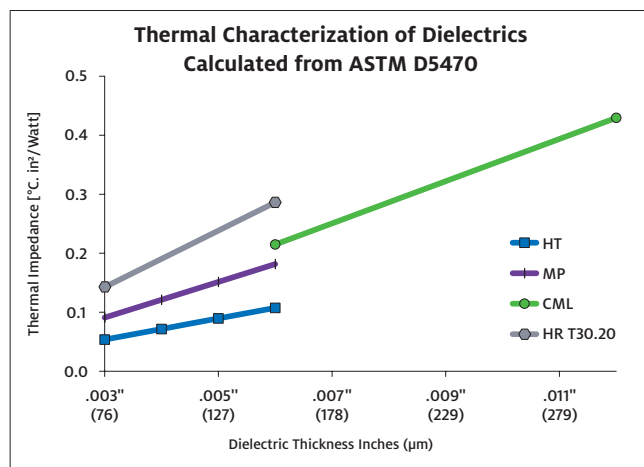

$$\text{TOTAL IMPEDANCE} = \frac{\text{Sample Thickness}}{\text{Thermal Conductivity}} + \text{Interfacial Resistance}$$

Lower Thermal Impedance = Lower Junction Temperatures

Dielectric Performance Considerations

Peel Strength



This chart graphs the stability of the bond strength between the dielectric and the circuit layer during temperature rise. Although bond strength goes down at higher temperatures, it maintains at least 3 lbs/inch (0.53 N/mm) even at 175°C.

Storage Modulus



This chart depicts the storage modulus of the material over a temperature range. All of our dielectrics are robust, but you will want to choose the one that best suits your operating temperature environment. See "Assembly Recommendations" on pages 18-19 for additional information.

Coefficient of Thermal Expansion



Thermomechanical Analysis (TMA) measures the dimensional stability of materials during temperature changes, monitoring the Coefficient of Thermal Expansion (CTE). Note: In the application, the CTE of the base material is a dominant contributor to thermal mechanical stress. See pages 14-15 for base layer selection.

CTE OF IMS BOARDS - The concerns in exceeding T_g in standard FR-4 materials from a mechanical standpoint should be tempered when using THERMAL CLAD. The ceramic filler in the polymer matrix of THERMAL CLAD dielectrics results in considerably lower Z-axis expansion than in traditional FR-4 materials, while the low thickness of the dielectric means significantly less strain on plated-through-hole (PTH) connections due to expansion.

Operating THERMAL CLAD Materials Above T_g

Above the T_g of the material, mechanical and electrical properties begin to change. Mechanical changes of note are a reduction of peel strength of the copper foil, an increase in the CTE, and decreasing storage modulus. There is a potential benefit of relieving residual stress on the dielectric interfaces, in solder joints and other interconnects due to CTE mismatches by choosing a dielectric with T_g below the operating temperature. The dielectric material above T_g is in its elastomeric state (much lower storage modulus), allowing some of the stresses to relax. Changes in electrical properties must also be considered in operation above T_g , although they are typically only important at frequencies above 1 MHz. Effects to consider are changes in the permittivity, dielectric loss and breakdown strength of the material. Important Note: Many THERMAL CLAD products have UL rating up to 45% higher than their glass transition temperature and are used extensively in applications above rated T_g .

Summary Of Key Product Characteristics

Performance Characteristics									
SINGLE LAYER		PRODUCT PERFORMANCE			DIELECTRIC PERFORMANCE			OTHER	
Part Number	Thickness ¹ [.000"/μm]	Thermal Performance ² [°C/W]	Impedance ³ [°C in ² /W] / [°C cm ² /W]	Conductivity ² [W/m-K]	Breakdown ⁵ [kVAC]	Permittivity ⁶ [Dielectric Constant]	Dielectric Conductivity ⁴ [W/m-K]	Glass Transition ⁷ [°C]	Peel Strength ⁸ [lbs/in] / [N/mm]
HPL-03015	1.5/38	0.30	0.02 / 0.13	7.5	5.0	6	3.0	185	5 / 0.9
HT-04503	3/76	0.45	0.05 / 0.32	4.1	8.5	7	2.2	150	6 / 1.1
HT-07006	6/152	0.70	0.11 / 0.71	4.1	11.0	7	2.2	150	6 / 1.1
MP-06503	3/76	0.65	0.09 / 0.58	2.4	8.5	6	1.3	90	9 / 1.6
MULTI-LAYER									
HT-09009	9/229	0.90	0.16 / 1.03	4.1	20.0	7	2.2	150	6 / 1.1
HT-07006	6/152	0.70	0.11 / 0.71	4.1	11.0	7	2.2	150	6 / 1.1
CML-11006*	6/152	1.10	0.21 / 1.35	N/A	10.0	7	1.1	90	10 / 1.8
LAMINATE ONLY									
HR T30.20	3/76	0.9	0.15 / 0.97	1.5	7.5	7	1.0	90	9 / 1.6

*CML is available in prepreg form only

Method Description

1 - Optical	2 - MET-5.4-01-40000-Test Thermal Performance of Insulated Metal Substrates (IMS)	3 - Calculation from ASTM 5470	4 - Extended ASTM 5470	5 - ASTM D149, See page 16	6 - ASTM D150	7 - MET-5.4-01-7800	8 - ASTM D2861
-------------	---	--------------------------------	------------------------	----------------------------	---------------	---------------------	----------------

Note: For applications with an expected operating voltage of 480 Volts AC or above, Henkel recommends a dielectric thickness greater than 0.003" (76μm).
Note: Circuit design is the most important consideration for determining safety agency compliance.
Breakdown Voltage does not represent max operating or proof test voltage. For additional information reference page 16.

Operating Temperatures

Choose the dielectric that best suits your operating temperature environment. For high temperature applications, such as automotive, HT offers the right solution. All of our dielectrics are UL recognized.

MATERIAL	RTI - ELECTRO / MECHANICAL PER U.L. 746 E	CTI*
HPL	140°C / 140°C	0 / 600
HT	140°C / 140°C	0 / 600
MP	130°C / 140°C	0 / 500 (425)
CML	130°C / 130°C	NA / NA
HR T30.20	150°C / 155°C	0 / 600

+CTI=Comparative Tracking Index - ASTM D3638 / IEC 60112

MATERIAL	U.L. SOLDER LIMIT RATING
HPL*	325°C / 60 seconds
HT*	325°C / 60 seconds
MP	300°C / 60 seconds
CML	260°C / 60 seconds
HR T30.20*	325°C / 60 seconds

*Covers all soldering options including Eutectic Gold / Tin.



Thermal Performance

This drawing represents the MET-5.4-01-40000-Test Thermal Performance of Insulated Metal Substrates (IMS) TO-220 thermal performance (25°C Cold Plate Testing).

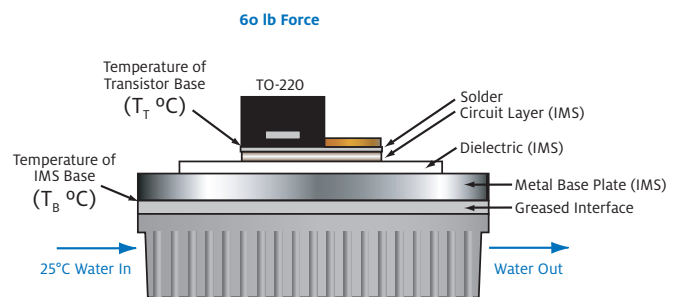

$$\theta \left(\frac{^{\circ}\text{C}}{\text{W}} \right) = \frac{(T_T - T_B)}{40\text{W typ}}$$

Advanced Circuit Processing

Two-Layer Systems Using THERMAL CLAD Circuits

Henkel's BERGQUIST brand dielectrics are ideal for applications requiring a two-layer solution. Two-layer constructions can provide shielding protection and additional electrical interconnects for higher component density. Henkel's BERGQUIST brand dielectrics will provide superior thermal performance over traditional FR-4 constructions. In addition, thermal vias can maximize thermal capabilities for applications utilizing power components. When vias can not be used, selecting higher performance dielectrics can solve thermal issues independently (see graph, below).

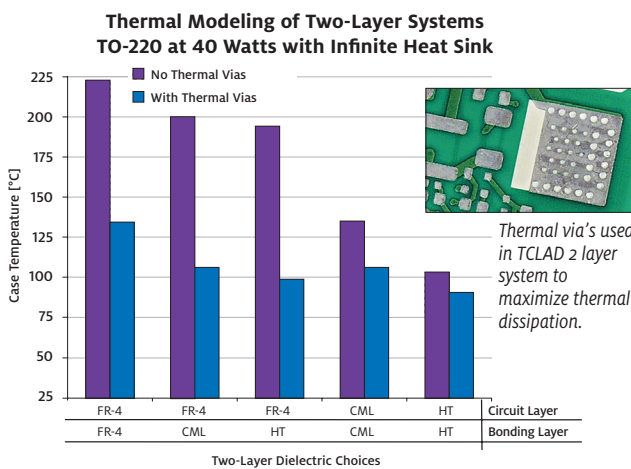

The graph depicts the modeled thermal result of various two-layer constructions as a function of device case temperature. The emphasis is the thermal effect of proper vias utilization.

DBC Replacement Replace Ceramic Substrates

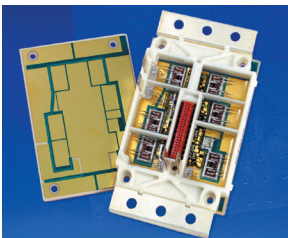

THERMAL CLAD can replace large-area ceramic substrates. It can also be used as a mechanically durable support for ceramic circuits or direct-bond copper subassemblies. The copper circuit layer of THERMAL CLAD has more current carrying capability than thick-film ceramic technology.

THERMAL CLAD has replaced ceramics and DBC in applications due to mechanical robustness and its ability to be fabricated in a wide variety of form-factors.

Direct Die Application

Direct die attach and wirebond are increasingly popular methods of component mounting to THERMAL CLAD substrates. A key benefit to this structure is lower thermal resistance as compared to conventional surface mount component packages soldered to an IMS substrate.

When designing circuits using Chip-On-Board (COB) technology it is important to use the appropriate surface finish to achieve excellent die mounting and wire bond connections. The die attachment is accomplished using SnPb, Pb-free solders, eutectic gold/tin solder or an electrical/thermal conductive adhesive, depending on the application requirements to adhere the die to the substrate. The wirebonding performed to make circuit connections is usually either gold or aluminum. ENEPIG (Electroless Nickel/Electroless Palladium/Immersion Gold) or Immersion Silver is recommended for gold wire and ENIG (Electroless Nickel/ Immersion Gold) for aluminum wire applications. HT dielectrics are UL solder rated at 325°C/60 seconds, enabling Eutectic Gold/Tin solders.

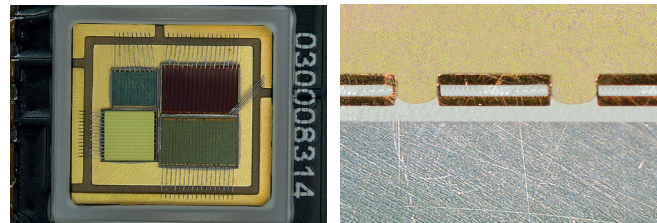

Close-up view of direct die attachment in an LED application. The THERMAL CLAD substrate is used to mount the die or module.

Henkel has the ability to laminate heavy copper up to 5 oz. (175µm) finished on the internal layer utilizing a thicker deposit of HT dielectric.

Heavy Copper

Applications requiring heavy copper for high current or heat spreading are not limited to single-layer needs. The ability to have internal layers of heavy copper can provide greater application flexibility. Direct access to the internal copper layer to directly attach or mount components provides unique applications capability. Look for opportunities to reduce the copper thickness. In many applications, Henkel's BERGQUIST brand TCLAD thermal performance reduces the need for heavy copper.

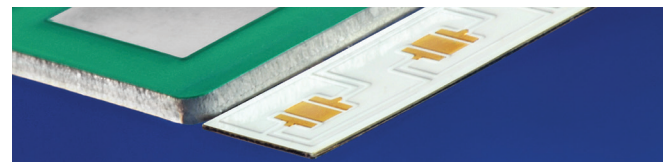

Photographic example of UTC versus a standard 0.062" (1.57mm) aluminum substrate.

Ultra Thin Circuits

Ultra Thin Circuits (UTC) utilize TCLAD dielectrics without the typical thick base layer. These circuits are often used for component level packaging where the thick aluminum or copper base is not required for mechanical or thermal mass. The circuit layer is a "stand-alone" ceramic submount replacement where the heat spreading and heat sinking is done in a different location. In addition, UTC can often be used for standard component package mounting. In some cases, the thermal performance and heat dissipation of the UTC is adequate to eliminate the need for heat sinking altogether. The total profile of a UTC can be as thin as 0.009" (0.23mm) and can be built up into multilayer structures. This type of structure is also available with BOND-PLY 450 thermally conductive PSA tape pre-applied to the back. See page 17 for examples of this format.

Custom Baseplate Applications



Selective Dielectric Removal

Henkel has developed a process for selectively removing dielectric to expose the baseplate. This surface can be surface finished like the other circuit pads. We are not limited to geometry or size of the dielectric removal area. Selective removal features can be placed very accurately with respect to the circuits.

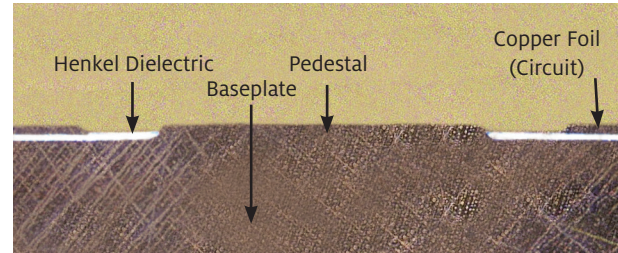

Pedestal

Using a copper base and by selectively removing the dielectric a pedestal can be formed moving the baseplate metal up to be co-planar with adjacent circuits.



Blind Plated Via to Baseplate

Allows for a copper base metal connection to the surface copper circuit and the inner-layer copper circuit can also be included if required. Provides a direct thermal path to baseplate.

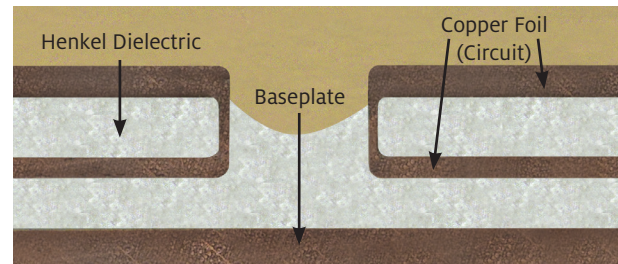

Electrical/Thermal Via

Typical "Thru Via" connecting inner to outer layer. Reduces thermal impedance by shortening the thermal path while maintaining electrical isolation.



Filled Via

This has been filled with an electrical and thermally conductive polymer material. It is also overplated to provide a plateable, solderable and nearly coplanar surface that is void free.

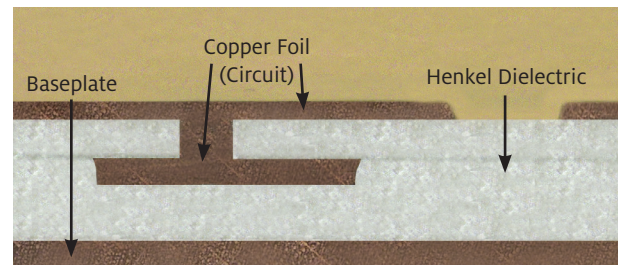

Filled Via

This has been filled with an electrical and thermally conductive polymer material. It is also overplated to provide a plateable, solderable and nearly coplanar surface that is void free.

For more detail regarding design and tolerance recommendations for active baseplates, please contact your Henkel representative for a White Paper.

Baseplate Design Considerations

METAL / ALLOY	THERMAL CONDUCTIVITY [W/m-K]	COEFFICIENT OF THERMAL EXPANSION [ppm/K]	DENSITY [g/cc]	MODULUS OF RIGIDITY [GPa]	YIELD STRENGTH [MPa]
Copper	400	17	8.9	44.1	310
Aluminum 5052	140	25	2.7	25.9	215
Aluminum 6061	170	25	2.7	26	230

Coefficient Of Thermal Expansion And Heat Spreading

The adjacent graph depicts the CTE of the baseplate material in relationship to the heat spreading capability of the metal. Although Aluminum and Copper are the most popular baseplates used in THERMAL CLAD, other metals and composites have been used in applications where CTE mismatch is a factor. The adjacent table represents standard and non-standard baseplate materials.



Coefficient Of Thermal Expansion And Solder Joints

Solder joint fatigue can be minimized by selecting the correct base layer to match component expansion. The major concern with thermal expansion is the stress the solder joint experiences in power (or thermal) cycling. Stress induced by heating and cooling may cause the joint to fatigue as it absorbs stress. Large devices, extreme temperature differential, badly mismatched materials, or lead-free minimum solder thickness may all place increased cyclic strain on solder joints.

Solder joint fatigue is typically first associated with ceramic based components and with device termination. The section on "Assembly Recommendations" (page 20-21) covers these issues in more detail.

Extra Long Circuits

Finished circuits up to 26" (660mm) long



Base Thickness

Copper and aluminum THERMAL CLAD is normally purchased in one of the standard-gauge thicknesses shown in the table below. Non-standard thicknesses are also available.

Electrical Connections To Baseplate

If a connection to the base plate is desired, copper is the most compatible base layer to use. When using electrical or thermal vias, it is important to match the circuit and base coefficients of thermal CTE expansion as closely as possible. Otherwise, excessive stress to the plated-hole will occur during thermal cycles. Other base layer materials can be used for connection, but will require different connection schemes.

Costs

The most cost effective base layers are aluminum and copper because they represent industry standards. Copper is more expensive than aluminum when comparing the like thicknesses, but can be a competitive option if design considerations allow for a thinner copper base. As an example, typically the cost of 0.040" (1.0mm) copper is equal to the cost of 0.125" (3.2mm) aluminum.

ALUMINUM - THICKNESSES	
Inches	Millimeters
0.020	0.51
0.032	0.81
0.040*	1.02*
0.062*	1.57*
0.080	2.03
0.125	3.18
0.160	4.06
0.190	4.83

COPPER - THICKNESSES	
Inches	Millimeters
0.020	0.51
0.031	0.79
0.040*	1.02*
0.060	1.52
0.080	2.03
0.125	3.18

*Standard thicknesses

Surface Finish

Aluminum and copper base layers come with a uniform commercial quality brushed surface. Aluminum is also available anodized or with other conversion coatings.

Standard THERMAL CLAD Panels

Available in:

- 18" (457mm) x 24" (610mm)
Usable area: 17" (432mm) x 23" (584mm)
- 18" (457mm) x 25" (635mm)
Usable area: 17" (432mm) x 24" (610mm)
- 20" (508mm) x 24" (610mm)
Usable area: 19" (483mm) x 23" (584mm)



Selecting A Circuit Layer

Current Carrying Capabilities

The circuit layer is the component-mounting layer in THERMAL CLAD. Current carrying capability is a key consideration because this layer typically serves as a printed circuit, interconnecting the components of the assembly. The advantage of THERMAL CLAD

is that the circuit trace interconnecting components can carry higher currents because of its ability to dissipate heat due to I²R loss in the copper circuitry.

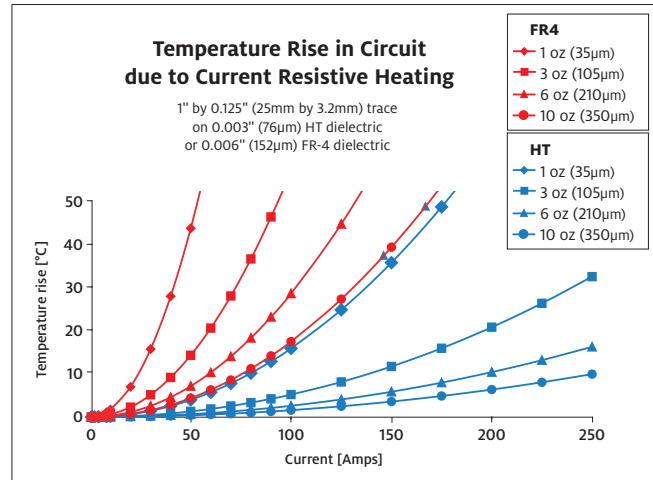

Relative temperature rise comparison graph depicts the significant difference between Henkel Dielectric HT and FR-4. Additional comparison charts regarding all Henkel Dielectrics are available. Note: No base metal used in calculation.

Temperature rise comparison graph depicts the significant difference between Henkel Dielectric HT and FR-4. Additional comparison charts regarding all Henkel Dielectrics are available. Note: No base metal used in calculation.



Want a cost effective, optimized circuit design?

This THERMAL CLAD White Paper addresses

specific design recommendations

including mechanical, circuit,

soldermask, fabrication and test options

to help optimize your design.

Heat Spreading Capability

Dielectric thickness and foil thickness both influence heat spreading capability in THERMAL CLAD. Heat spreading is one of the most powerful advantages derived from IMS. By increasing copper conductor thickness, heat spreading increases and brings junction temperature down. In some cases very heavy copper can be utilized along with bare die to eliminate the need for a standard packaged component.

The following graphs depict both the thermal impedance value and case temperature when relating dielectric and foil thickness.



Ultra Thin Circuits utilizing BOND-PLY 450 PA. See pages 12 and 20 for additional information.



Standard Circuit Layer Thickness			
MATERIAL	WEIGHT (oz/ft²)	REFERENCE inches	THICKNESS µm
Copper (Zinc Treatment)	0.5	0.0007	18
	1	0.0014	35
	2	0.0028	70
	3	0.0042	105
	4	0.0056	140
	5	0.0070	175
	6	0.0084	210
	8	0.0112	280
	10	0.0140	350

NOTE: Copper foil is NOT measured for thickness as a control method. Instead, it is certified to an area weight requirement per IPC-4562. The nominal thickness given on 1 oz. copper is 0.0014" (35 µm).

CAUTION! Values in IPC-4562 (Table 1.1) are not representative of mechanical thickness.

Electrical Design Considerations

Proof Test

The purpose of “Proof Testing” THERMAL CLAD substrates is to verify that no defects reside in the dielectric material. Because testing requires that voltages be above the onset of partial discharge, we recommend the number of “Proof Tests” be kept at a minimum.

The term “Partial Discharge” includes a broad spectrum of life reducing (i.e. material damaging) phenomena such as:

1. Corona discharge
2. Treeing and surface tracking contamination
3. Surface discharges at interfaces, particularly during fault induced voltage reversal
4. Internal discharges in voids or cavities within the dielectric



“Proof Test” fixture to test multiple number of finished circuit boards at one time.

The purpose of the “Proof Test” is to verify that there has been no degradation of the dielectric insulation due to the fabrication process or any material defects. Continued testing at these voltage levels will only take away from the life of the dielectric on the circuit board. It has been repeatedly verified that “Proof Testing” above the inception of partial discharge (700 VAC or 1200 VAC with proper use of soldermask) will detect any and all defects in the dielectric isolation in the THERMAL CLAD circuit board. Any micro-fractures, delaminations or micro-voids in the dielectric will breakdown or respond as a short during the test.

The use of a DC “Proof Test” is recommended, from an operator safety standpoint. The voltage levels typically used are 1500 to 2250 VDC. Due to the capacitive nature of the circuit board construction, it is necessary to control the ramp up of the voltage to avoid nuisance tripping of the failure detect circuits in the tester and to maintain effective control of the test. This is to avoid premature surface arcing or voltage overshoot. There is safety consideration when DC testing, in that the operator must verify the board tested is fully discharged, prior to removing from the test fixture. A more detailed discussion of “Proof Test” is available upon request.

Breakdown Voltage

The ASTM D149 definition of dielectric breakdown voltage is: the potential difference at which dielectric failure occurs under prescribed conditions in an electrical insulating material located between two electrodes. This is permanent breakdown and is not recoverable. ASTM goes on to state that the results obtained by this test can seldom be used directly to determine the dielectric behavior of a material in an actual application. This is not a test for “fit for use” in the application, as is the “Proof Test”, which is used for detection of fabrication and material defects to the dielectric insulation.

Due to circuit board construction and layout, it is always recommended to “Proof Test” at a value which is less than 50% of the specified ASTM D149 dielectric breakdown voltage. This should include provisions for creepage distance to avoid surface arcing to the metal base.

Leakage Current HiPot Testing

Due to the variety of dielectric types, thicknesses and board layouts, not all boards test alike. All insulated metal substrates closely resemble a parallel plate capacitor during HiPot testing. Capacitance is equal to:

$$C = \epsilon A/d$$

where:

ϵ = Permittivity (Dielectric Constant)

A = Surface Area

d = Distance (Dielectric Thickness)

The capacitance value changes with different configurations of materials and board layouts. This can be demonstrated where one board fails the test and another passes, but when both are actually tested for dielectric strength and leakage current in a controlled environment, both pass. Therefore, it is very important to properly design the testing and test parameters with the material characteristics in mind. Test set-up and parameters that over-stress or do not consider reactance of the material and its capacitive and resistive components, can lead to false failures and/or test damage of the board.

Another test characteristic that is generally misunderstood with insulated metal substrates is the leakage and charge current that take place during the test. In most cases, the leakage current value on insulated metal substrates is much smaller than the measurement capability of a typical HiPot tester. What is most misunderstood is the charge current that takes place during the test. Leakage current measurements can only be realized once the board has been brought to the full test voltage (DC voltage) and is held at that voltage during the test. This current value and rate di/dt is directly related to the capacitance of the board. Therefore, a board that has an effective capacitance higher than another board will have a higher charge current rate than the one with a lower effective capacitance. This does not reflect the leakage current or the voltage withstand of the dielectric insulation instead, it represents the characteristic transient response of the dielectric. Therefore, one is not able to determine comparable leakage current based on the instantaneous charge current. For accurate leakage test data, bring the board up to full DC test voltage and hold.

Creepage Distance And Discharge

Creepage distance and discharge has to be taken into account because THERMAL CLAD dielectrics often incorporate a metal base layer. Circuit board designers should consider “Proof Testing” requirements for: conductor-to-conductor and conductor-to-circuit board edge or through holes. The graphs below depict flashover: without soldermask, with soldermask and under oil.



Assembly Recommendations

Solder Assembly

Solder joints deserve additional consideration in the design of THERMAL CLAD assemblies. This section covers solder surface finishes, application and thickness, alloy and flux.

Surface Finishes

Standard circuit board finishes are available for THERMAL CLAD circuit boards.

- ENIG (Electroless Nickel/Immersion Gold)
- ENEPIG (Electroless Nickel/Electroless Palladium/Immersion Gold)
- OSP (Organic Solderability Protectant)
- Immersion Silver or Immersion Tin
- Lead-Free HASL or Standard Tin/Lead HASL
- Electrolytic Gold - for edge connectors

Application and Thickness - Solder Paste

With the majority of applications now requiring lead-free soldering, there are still some specialized applications using the Tin-Lead solder paste. In either case, the final solder joint is key to long-term reliability. The solder joint thickness, component alignment and solder fillet requirements should comply with the industry standard: IPC-A-610 "Acceptability of Electronic Assemblies". The section on solder joints for surface mount assemblies provides the information on acceptance criteria for solder joints. It also describes defects that will require rework to meet acceptance levels.

Note: Additional thickness and/or larger stencil opening may need to be utilized for RoHS compliance applications. Use profile recommended by the component manufacturer.



Wire soldering on THERMAL CLAD.



Your most popular LED footprints are available through distribution. Contact Henkel Sales for more information.



Now Available

TCLAD BOND-PLY 450 PA

THERMAL CLAD with BOND-PLY 450 PA is a thermally conductive adhesive tape that features a release liner on the back side for easy removal and application to a heat sink. TCLAD PA substrate release liners can withstand high temperatures and will maintain adhesion and release characteristics even after exposure to the extreme heat of solder reflow. For a complete data sheet, contact Henkel Sales.



Connection Techniques

Connection techniques common throughout the industry are being used successfully on THERMAL CLAD IMS substrates. Surface mount connectors are manufactured using plastic molding materials with thermal coefficients of expansion that roughly match the characteristics of the baseplate metal. However, the plastic molding compounds do have a different thermal capacity and thermal conductivity that can cause stress in the assembly as it cools after soldering and during any significant temperature excursion. Process-caused thermal mechanical stress is specific to the solder reflow process used. For this reason, designs that capture the metal pin without rigidity are preferred, particularly if the major dimension of the connector is large.

Pin Connectors

Pin connectors and pin headers are often used in THERMAL CLAD assembly when an FR-4 panel is attached to a THERMAL CLAD assembly. The differential coefficient of expansion between the control panel and the base metal will cause stress in the solder joint and dielectric. The most advanced designs incorporate stress relief in the fabrication of the pin. Redundant header pins are often used to achieve high current carrying capacity.

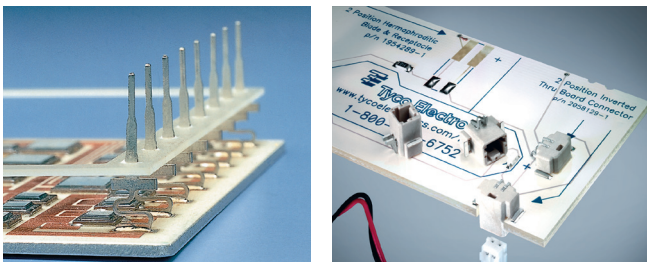

Manufacturers such as AutoSplice and Zierick have off the shelf pins ideal for IMS applications. Custom pins and connectors are also available.

This Tyco Electronics™ SMT thru-board connector provides a way to bring power from the underside of a THERMAL CLAD IMS board, eliminating issues of dressing wires on the top side of LED boards.

Power Connections

Only a few companies supply spade or threaded fastener connectors for surface mount power connections. In many cases these are lead frame assemblies soldered to the printed circuit pads and bent to accommodate the shell used for encapsulation. Designs incorporating stress relief and a plastic retainer suitable for high amperage are also available. Thru-board connectors will require adherence to fabrication design rules for IMS PWB's.

Edge Connectors

When using edge connectors as part of the THERMAL CLAD printed wiring pattern, it is suggested that interfacing conductors be finished with an electrolytic hard gold plating over sulfamate nickel plating. A 45° chamfer is recommended when using an edge connector. Remember to maintain the minimum edge to conductor distance to prevent shorting.

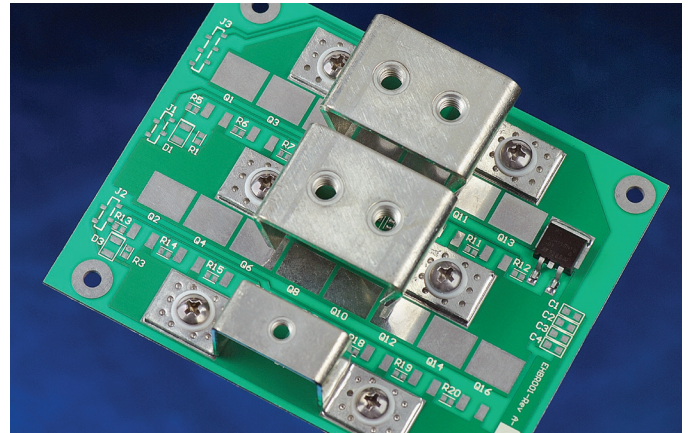

Custom Connectors

In the example above, the application required a large cable connection to the THERMAL CLAD IMS board. Precautions were taken for the best electrical connection with minimized mechanical strain on the etched circuit. This solution addresses both electrical and mechanical fastening. The small holes allow for complete void-free soldering. Also, the insulated shoulder washer prevents shorting to the base plate. These types of connectors are usually custom made and are not commercially available.

Wire Bonding Direct Die Attach

Wire bonding is particularly useful in the design of packages with Chip-On-Board (COB) architecture. This technique uses the surface mount and interconnect capability of THERMAL CLAD in a highly efficient thermal design. See page 12 for additional information.

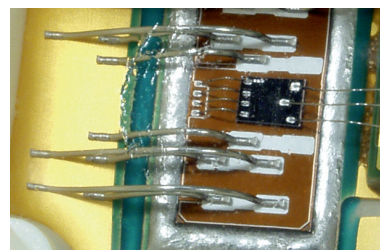

Close up view of a direct die attachment in a power application.

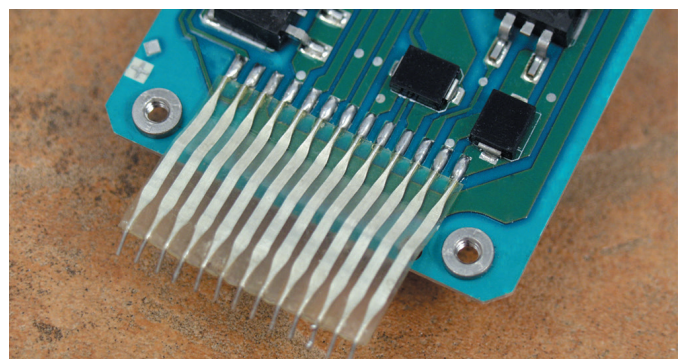

Flex attachment on THERMAL CLAD.

Solutions For Surface-Mount Applications



HI-FLOW

The HI-FLOW family of phase change materials offers an easy-to-apply thermal interface for many surface mount packages. At the phase change temperature, HI-FLOW materials change from a solid and flow with minimal applied pressure. This characteristic optimizes heat transfer by maximizing wet-out of the interface. HI-FLOW is commonly used to replace messy thermal grease.

Henkel phase change materials are specially compounded to prevent pump-out of the interface area, which is often associated with thermal grease. Typical applications for HI-FLOW materials include:

- DC/DC converters
- Power modules

HI-FLOW materials are manufactured with or without film or foil carriers. Custom shapes and sizes for non-standard applications are also available.

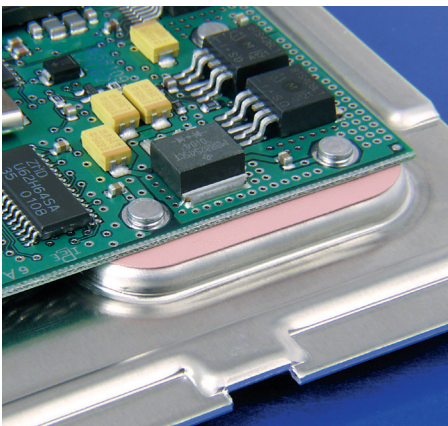

SIL-PAD™

SIL-PAD is the benchmark in thermal interface materials. The SIL-PAD family of materials are thermally conductive and electrically insulating. Available in custom shapes, sheets, and rolls, SIL-PAD materials come in a variety of thicknesses and are frequently used in SMT applications such as:

- Interface between thermal vias in a PCB, and a heat sink or casting
- Heat sink interface to many surface mount packages



Where Thermal Solutions Come Together

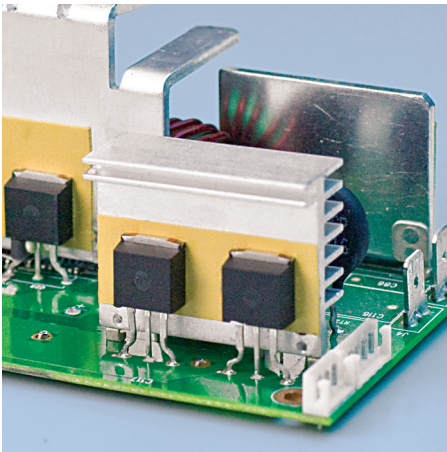

BOND-PLY and LIQUI-BOND

The BOND-PLY family of materials are thermally conductive and electrically isolating. Bond-Ply is available in a pressure sensitive adhesive or laminating format. BOND-PLY provides for the mechanical decoupling of bonded materials with mismatched thermal coefficients of expansion. LIQUI-BOND is a high thermal performance liquid silicone adhesive that cures to a solid bonding elastomer. Typical applications include:

- Bonding bus bars in a variety of electronic modules and sub assemblies
- Attaching a metal-based component to a heat sink
- Bonding a heat sink to a variety of ASIC, graphic chip, and CPU packages
- Bonding flexible circuits to a rigid heat spreader or thermal plane
- Assembly tapes for BGA heat spreader
- Attaching PCB assemblies to housings



GAP PAD™ and Gap Filler

The GAP PAD product family offers a line of thermally conductive materials, in pad or liquid dispensable format, which are highly conformable. Varying degrees of thermal conductivity and compression deflection characteristics are available. Typical applications include:

- On top of a semiconductor package such as a QFP or BGA. Often times, several packages with varying heights can use a common heat sink when utilizing GAP PAD.
- Between a PCB or substrate and a chassis, frame, or other heat spreader
- Areas where heat needs to be transferred to any type of heat spreader
- For interfacing pressure sensitive devices
- Filling various gaps between heat-generating devices and heat sinks or housings

GAP PADS are available in thickness of 0.010" (0.254mm) to 0.250" (6.35mm), and in custom shapes, with or without adhesive. Gap Fillers are available in cartridge or kit form.

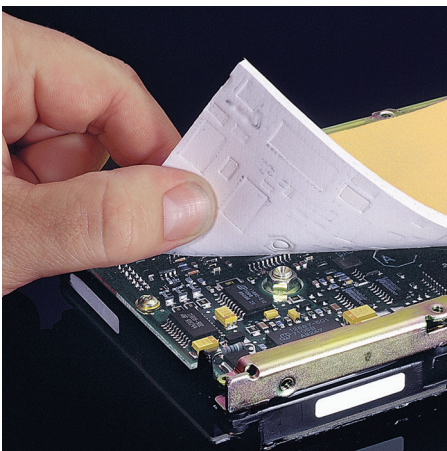

The Path You Take Is Yours

Henkel's full line of liquid polymers make it easy to customize your material, pattern, volume and speed.

Henkel's advanced liquids are specifically designed to support optimized dispensing control with excellent thermal conductivity. Dispensed in a liquid state the material creates virtually zero stress on components. It can be used to interface and conform to the most intricate topographies and multi-level surfaces.



THERMAL CLAD Configurations

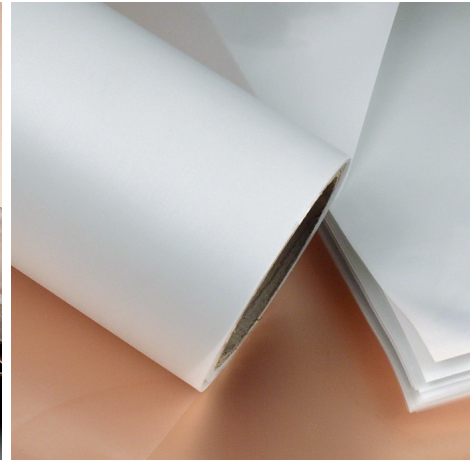

Custom Circuit

Henkel's BERGQUIST brand THERMAL CLAD substrates are custom configured to your design parameters at our Prescott, Wisconsin facility. Our field application support personnel in conjunction with our mechanical and process engineers are available to assist you in taking your design from paper to finished product. Engineering is available for the following construction parameters and options.

- Artwork layout recommendations
- Base metal requirements and mechanical configuration
- Dielectric thickness
- Copper weights (18-350 μ m / .5-10 oz)
- Solder mask layouts
- All common circuit finishes
- Tooling/singulation options

Panel Form

Additional base metal sizes and thickness options are available

Dimensions:

- 18" x 24" (457mm x 610mm)
- 18" x 25" (457mm x 635mm)
- 20" x 24" (508mm x 610mm)
- Foil Thickness: 18-350 μ m (.5-10 oz)

Base Plate Metals:

- Aluminum 6061-T6, 5052-H34, standards from 0.020" to 0.190" (0.5mm to 4.83mm)
- Copper 110 Full-Hard, standard from 0.020" to 0.125" (0.5mm to 3.2mm)

Sheet And Roll Format

CML (Circuit Material Laminate) is a ceramic filled polymer that forms a strong, thermally conductive bond to metal heat spreaders and is an excellent alternative to pre-preg.

- 24" (610mm) Roll Standard (custom sizes are available)
- Maximum roll length of 2000' (610m)
- Sheets 18" x 24" (457mm x 610mm) and 20" x 24" (508mm x 610mm)

UL Certifications Directory

The U.L. website provides the latest information regarding the UL recognition status of BERGQUIST THERMAL CLAD materials and "Prescott Operations" circuit fabrication.

Using the address: <http://www.ul.com>, select Online Certifications Directory. Enter "BERGQUIST" into the "Company Name" field and press the search button. Click on the link of one of the two U.L. File Numbers to view it: QMTS2.E121882 and ZPMV2.E122713.

- In each group there is guide information which will give a further description of the categories listed.
- In each group the recognized materials or fabricated circuit board types will be listed.

QMTS2.E121882

Polymeric Materials - Filament-wound tubing, Industrial Laminates, Vulcanized Fiber, and Materials for Use in Fabricating Recognized Printed Wiring Boards - Components.

ZPMV2.E122713

Wiring, Printed - Component

Appendix

ASTM	D 149	Test Methods for Dielectric Breakdown Voltage and Dielectric Strength of Solid Electrical Insulating Materials at Commercial Power Frequencies
	D 150	Test Methods for AC Loss Characteristics and Permittivity (Dielectric Constant) of Solid Electrical Insulating Materials
	D 257	Test Methods for DC Conductance or Impedance of Insulating Materials
	D 374	Test Methods for Thickness of Solid Electrical Insulation
	D 3165	Test Method for Strength Properties of Adhesives in Shear by Tension Loading of Single-Lap-Joint Laminated Assemblies
	D 5470	Test Methods for Thermal Transmission Properties of Thin Thermally Conductive Solid Electrical Insulating Materials
IEC	60093	Methods of test for volume resistivity and surface resistivity of solid electrical insulating materials
	60243-1	Methods of test for electric strength of solid insulating materials - Part 1: Tests at power frequencies
	60250	Recommended methods for the determination of the permittivity and dielectric dissipation factor of electrical insulating materials at power, audio, and radio frequencies including metre wavelengths
	60626-2	Combined flexible materials for electrical insulation- Part 2: Methods of test
IPC	2221	Generic Standard on Printed Board Design
	6012	Qualifications and Performance Specification of Rigid Printed Boards
	600	Acceptance of Printed Boards
	TM-650	Cleanliness (2.3.35 & 2.3.26)
	TM-650-2.4.22	Bow and Twist
	TM-650-2.4.8	Peel
	SM-840	Soldermask
	IPC-A610	Acceptability of Electronic Assemblies
Surface Mount	IPC-7351	Generic requirements for Surface Mount Design and Land Pattern Standards
ISO 4587	Adhesives	Determination of tensile lap-shear strength of rigid-to-rigid bonded assemblies

AMERICAS**HEADQUARTERS:****UNITED STATES**

Henkel Electronic Materials, LLC
14000 Jamboree Road
Irvine, CA 92606
USA

Tel: +1.888.943.6535

Fax: +1.714.368.2265

Henkel Electronic Materials, LLC
20021 Susana Road
Rancho Dominguez, CA 90221
USA

Tel: +1.310.764.4600

Fax: +1.310.605.2274

Henkel Electronic Materials, LLC
18930 W. 78th Street
Chanhassen, MN 55317
USA

Tel: +1.952.835.2322

Tel: +1.800.347.4572

Fax: +1.952.835.0430

BRAZIL

Henkel Brazil
Av. Prof. Vernon Kriebler, 91
06690-070 Itapevi,
Sao Paulo, Brazil

Tel: +55.11.3205.7001

Fax: +55.11.3205.7100

ASIA-PACIFIC**CHINA**

No. 332 Meigui South Road
WaiGaoQiao Free Trade Zone, Pu Dong
Shanghai 200131, P.R. China
Tel: +86.21.3898.4800
Fax: +86.21.5048.4169

Henkel Huawei Electronics CO. LTD
Songtiao Industrial Park Lianyungang
Jiangsu Province 222006 China
Tel: +86.518.8515.5343
Fax: +86.518.8515.3801

JAPAN

Henkel Japan Ltd.
27-7, Shin Isogo-cho
Isogo-ku Yokohama, 235-0017
Japan
Tel: +81.45.286.0161
Email: jp.ae-csdesk@henkel.com

KOREA

Henkel Technologies (Korea) Ltd.
6th Floor
Dae Ryung Techno Town II
33-33 Gasan-dong,
Geumcheon-gu, Seoul 153-771
Korea
Tel: +82.2.6675.8000
Fax: +82.2.6675.8191

SINGAPORE

Henkel Singapore Pte Ltd.
401, Commonwealth Drive
#03-01/02 Haw Par Technocentre,
Singapore 149598
Tel: +65.6266.0100
Fax: +65.6472.8738 / +65.6266.1161

EUROPE**BELGIUM**

Henkel Electronics Materials (Belgium)
N.V. Nijverheidsstraat 7
B-2260 Westerlo
Belgium
Tel: +32.1457.5611
Fax: +32.1458.5530

UNITED KINGDOM

Henkel Ltd.
Adhesives Limited Technologies House
Wood Lane End
Hemel Hempstead
Hertfordshire HP2 4RQ
Tel: +44.1442.278000
Fax: +44.1442.278071
henkel-adhesives.com/electronics
technomelt-simply3.com

Across the Board, 
Around the Globe.

www.henkel-adhesives.com/thermal