

# PNP SILICON PLANAR MEDIUM POWER DARLINGTON TRANSISTORS

**ZTX704**  
**ZTX705**

**ISSUE 3 – MAY 94**

## FEATURES

- \* 120 Volt  $V_{CE0}$
- \* 1 Amp continuous current
- \* Gain of 3K at  $I_C=1$  Amp
- \*  $P_{tot}=1$  Watt

## APPLICATIONS

- \* Lamp, solenoid and relay drivers

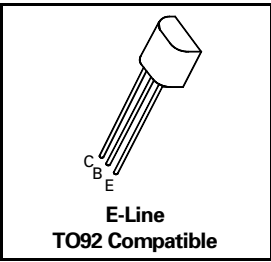

## ABSOLUTE MAXIMUM RATINGS.

PARAMETER	SYMBOL	ZTX704	ZTX705	UNIT
Collector-Base Voltage	$V_{CBO}$	-120	-140	V
Collector-Emitter Voltage	$V_{CEO}$	-100	-120	V
Emitter-Base Voltage	$V_{EBO}$		-10	V
Peak Pulse Current	$I_{CM}$		-4	A
Continuous Collector Current	$I_C$		-1	A
Power Dissipation at $T_{amb} = 25^\circ\text{C}$ derate above $25^\circ\text{C}$	$P_{tot}$		1 5.7	W mW/°C
Operating and Storage Temperature Range	$T_j; T_{stg}$		-55 to +200	°C

## ELECTRICAL CHARACTERISTICS (at $T_{amb} = 25^\circ\text{C}$ unless otherwise stated).

PARAMETER	SYMBOL	ZTX704		ZTX705		UNIT	CONDITIONS.
		MIN.	MAX.	MIN.	MAX.		
Collector-Base Breakdown Voltage	$V_{(BR)CBO}$	-120		-140		V	$I_C=-100\mu\text{A}$
Collector-Emitter Breakdown Voltage	$V_{CEO(SUS)}$	-100		-120		V	$I_C=-10\text{mA}^*$
Emitter-Base Breakdown Voltage	$V_{(BR)EBO}$	-10		-10		V	$I_E=-100\mu\text{A}$
Collector Cut-Off Current	$I_{CBO}$		-0.1 -10		-0.1 -10	$\mu\text{A}$ $\mu\text{A}$ $\mu\text{A}$ $\mu\text{A}$	$V_{CB}=-100\text{V}$ $V_{CB}=-120\text{V}$ $V_{CB}=-100\text{V}, T_{amb}=100^\circ\text{C}$ $V_{CB}=-120\text{V}, T_{amb}=100^\circ\text{C}$
Collector Cut-Off Current	$I_{CES}$		-10		-10	$\mu\text{A}$	$V_{CES}=-80\text{V}$
Emitter Cut-Off Current	$I_{EBO}$		-0.1		-0.1	$\mu\text{A}$	$V_{EB}=-8\text{V}$
Collector-Emitter Saturation Voltage	$V_{CE(sat)}$		-1.3 -2.5		-1.3 -2.5	V V	$I_C=-1\text{A}, I_B=-1\text{mA}^*$ $I_C=-2\text{A}, I_B=-2\text{mA}^*$
Base-Emitter Saturation Voltage	$V_{BE(sat)}$		-1.8		-1.8	V	$I_C=-1\text{A}, I_B=-10\text{mA}^*$
Base-Emitter Turn-On Voltage	$V_{BE(on)}$		-1.7		-1.7	V	$I_C=-1\text{A}, V_{CE}=-5\text{V}^*$

# ZTX704 ZTX705

## ELECTRICAL CHARACTERISTICS (at $T_{amb} = 25^{\circ}\text{C}$ ).

PARAMETER	SYMBOL	ZTX704		ZTX705		UNIT	CONDITIONS.
		MIN.	MAX.	MIN.	MAX.		
Static Forward Current Transfer Ratio	$h_{FE}$	3K 3K 3K 2K	30K	3K 3K 3K 2K	30K		$I_C = -10\text{mA}, V_{CE} = -5\text{V}^*$ $I_C = -100\text{mA}, V_{CE} = -5\text{V}^*$ $I_C = -1\text{A}, V_{CE} = -5\text{V}^*$ $I_C = -2\text{A}, V_{CE} = -5\text{V}^*$
Transition Frequency	$f_T$	160 Typical		160 Typical		MHz	$I_C = -100\text{mA}, V_{CE} = -10\text{V}$ $f = 20\text{MHz}$
Input Capacitance	$C_{ibo}$	90 Typical		90 Typical		pF	$V_{EB} = -0.5\text{V}, f = 1\text{MHz}$
Output Capacitance	$C_{obo}$	15 Typical		15 Typical		pF	$V_{CE} = -10\text{V}, f = 1\text{MHz}$
Switching Times	$t_{on}$	0.6 Typical		0.6 Typical		$\mu\text{s}$	$I_C = -0.5\text{A}, V_{CE} = -10\text{V}$ $I_{B1} = I_{B2} = -0.5\text{mA}$
	$t_{off}$	0.8 Typical		0.8 Typical		$\mu\text{s}$	

\*Measured under pulsed conditions. Pulse width=300 $\mu\text{s}$ . Duty cycle  $\leq 2\%$

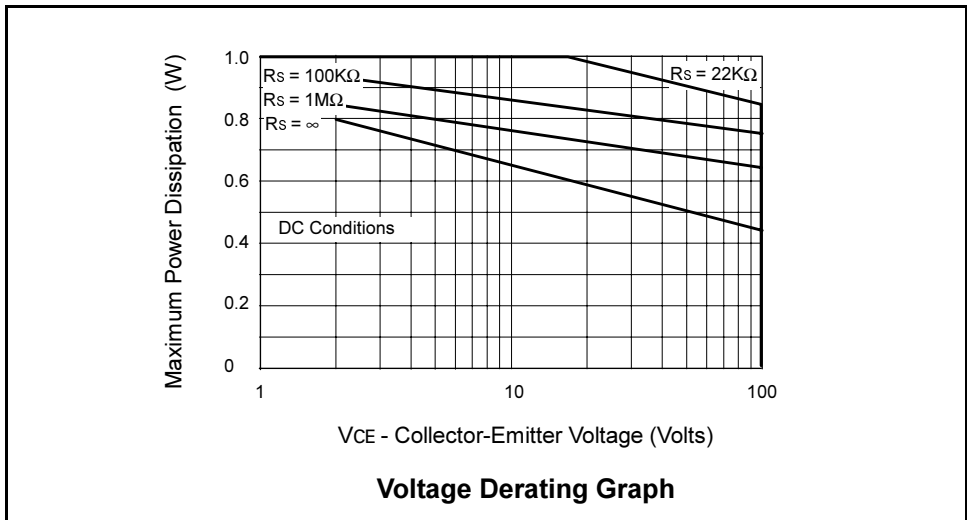

The maximum permissible operational temperature can be obtained from this graph using the following equation

$$T_{amb(max)} = \frac{Power(max) - Power(act)}{0.0057} + 25^{\circ}\text{C}$$

$T_{amb(max)}$  = Maximum operating ambient temperature

Power(max) = Maximum power dissipation figure, obtained from the above graph for a given  $V_{CE}$  and source resistance ( $R_S$ )

Power(actual) = Actual power dissipation in users circuit

# ZTX704 ZTX705

## TYPICAL CHARACTERISTICS

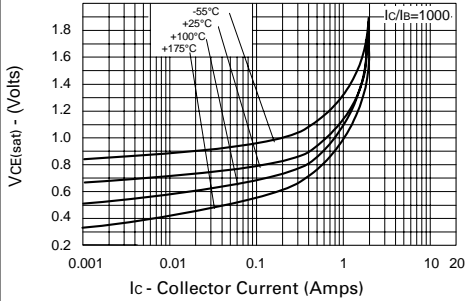

**$V_{CE(sat)}$  v  $I_C$**

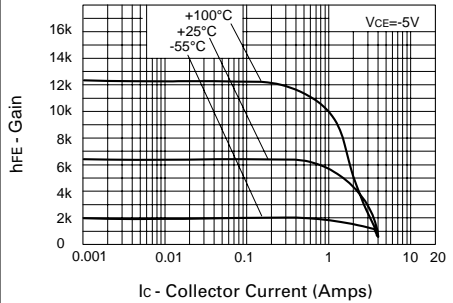

**hFE v  $I_C$**

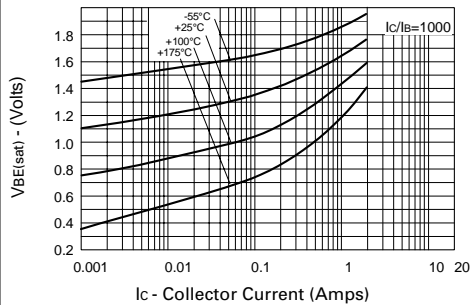

**$V_{BE(sat)}$  v  $I_C$**

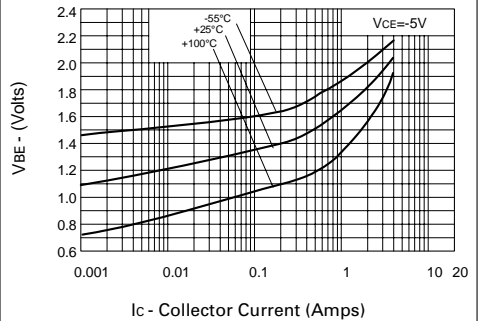

**$V_{BE(on)}$  v  $I_C$**

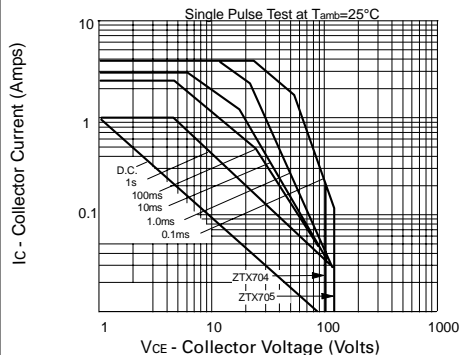

**Safe Operating Area**