

10A, 50V - 600V Glass Passivated Super Fast Rectifiers

FEATURES

- High efficiency, low VF
- High current capability
- High reliability
- High surge current capability
- Low power loss
- Compliant to RoHS Directive 2011/65/EU and in accordance to WEEE 2002/96/EC
- Halogen-free according to IEC 61249-2-21

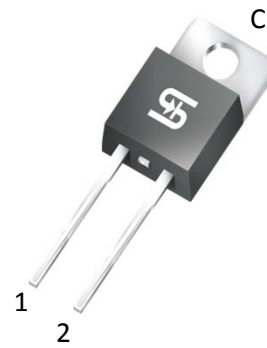

TO-220AC



MECHANICAL DATA

Case: TO-220AC

Molding compound, UL flammability classification rating 94V-0

Part no. with suffix "H" means AEC-Q101 qualified

Packing code with suffix "G" means green compound (halogen-free)

Terminal: Matte tin plated leads, solderable per JESD22-B102

Meet JESD 201 class 2 whisker test

Polarity: As marked

Mounting torque: 0.56 Nm max.

Weight: 1.8 g (approximately)



MAXIMUM RATINGS AND ELECTRICAL CHARACTERISTICS (T _A =25°C unless otherwise noted)										
PARAMETER	SYMBOL	SFA 1001	SFA 1002	SFA 1003	SFA 1004	SFA 1005	SFA 1006	SFA 1007	SFA 1008	UNIT
Maximum repetitive peak reverse voltage	V _{RRM}	50	100	150	200	300	400	500	600	V
Maximum RMS voltage	V _{RMS}	35	70	105	140	210	280	350	420	V
Maximum DC blocking voltage	V _{DC}	50	100	150	200	300	400	500	600	V
Maximum average forward rectified current	I _{F(AV)}	10								A
Peak forward surge current, 8.3 ms single half sine-wave superimposed on rated load	I _{FSM}	125								A
Maximum instantaneous forward voltage (Note 1) I _F =10 A	V _F	0.975			1.3		1.7			V
Maximum reverse current @ rated V _R T _J =25°C T _J =100°C	I _R	10 400								μA
Maximum reverse recovery time (Note 2)	t _{rr}	35								ns
Typical junction capacitance (Note 3)	C _J	70				50				pF
Typical thermal resistance	R _{θJC}	3.5								°C/W
Operating junction temperature range	T _J	- 55 to +150								°C
Storage temperature range	T _{STG}	- 55 to +150								°C

Note 1: Pulse test with PW=300μs, 1% duty cycle

Note 2: Test conditions: I_F=0.5A, I_R=1.0A, I_{RR}=0.25A

Note 3: Measured at 1 MHz and applied reverse voltage of 4.0V DC.

ORDERING INFORMATION					
PART NO.	PART NO. SUFFIX	PACKING CODE	PACKING CODE SUFFIX (*)	PACKAGE	PACKING
SFA100xG (Note 1)	H	C0	G	TO-220AC	50 / Tube

Note 1: "x" defines voltage from 50V (SFA1001G) to 600V (SFA1008G)

*: Optional available

EXAMPLE					
EXAMPLE P/N	PART NO.	PART NO. SUFFIX	PACKING CODE	PACKING CODE SUFFIX	DESCRIPTION
SFA1008GHC0G	SFA1008G	H	C0	G	AEC-Q101 qualified Green compound

RATINGS AND CHARACTERISTICS CURVES
($T_A=25^\circ\text{C}$ unless otherwise noted)

FIG.1 FORWARD CURRENT DERATING CURVE

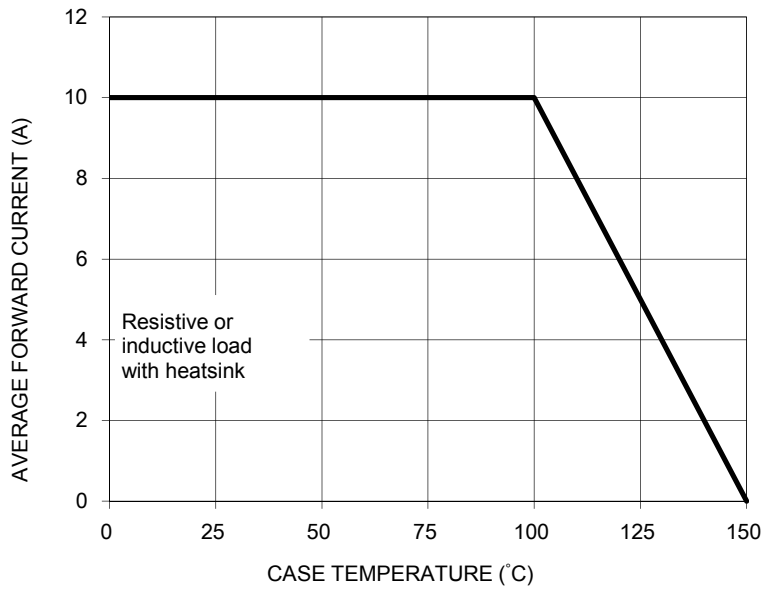

FIG. 2 TYPICAL REVERSE CHARACTERISTICS

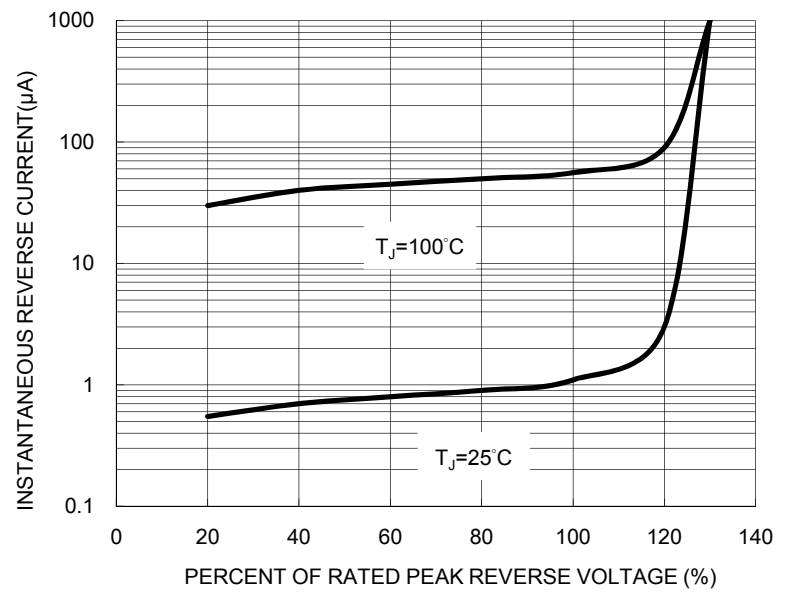

FIG. 3 MAXIMUM NON-REPETITIVE FORWARD SURGE CURRENT

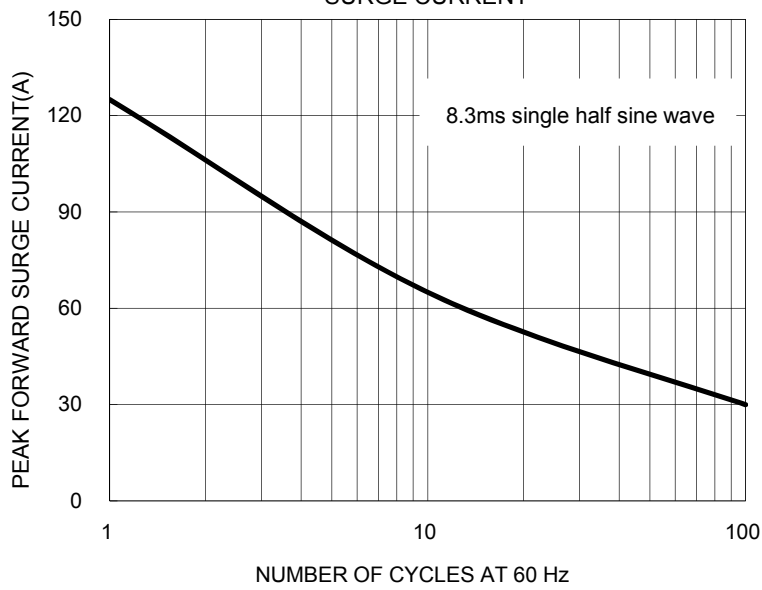

FIG. 4 TYPICAL FORWARD CHARACTERISTICS

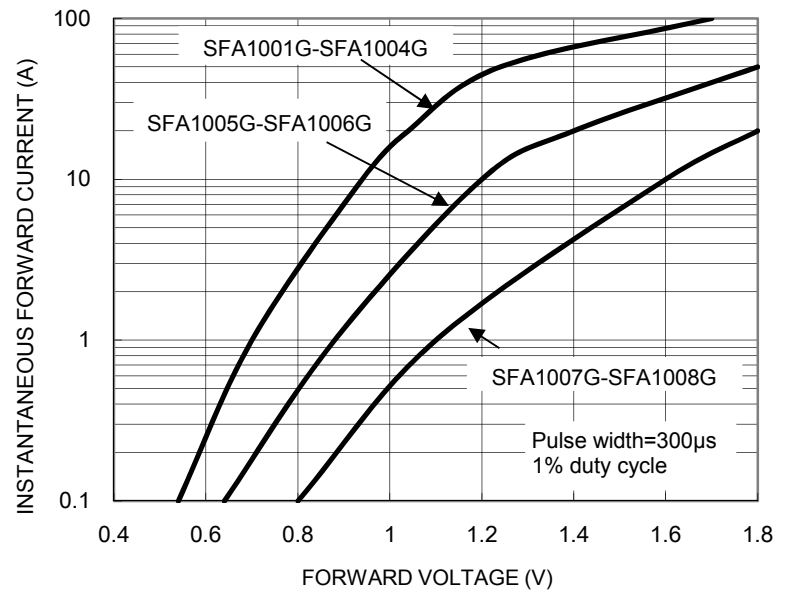

FIG. 5 TYPICAL JUNCTION CAPACITANCE

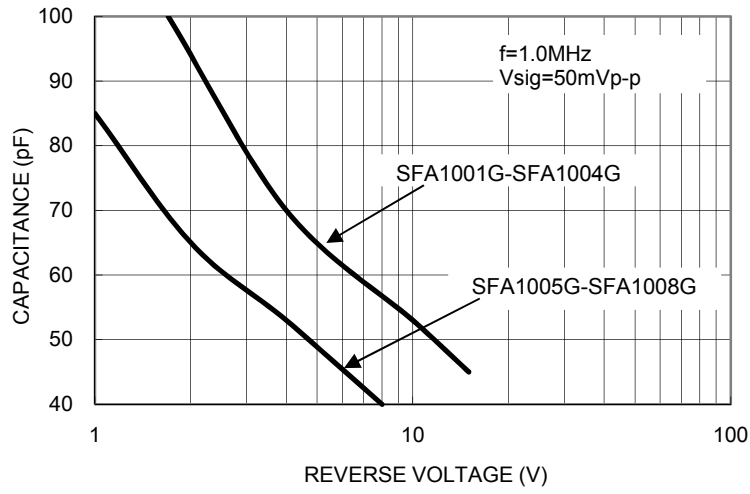
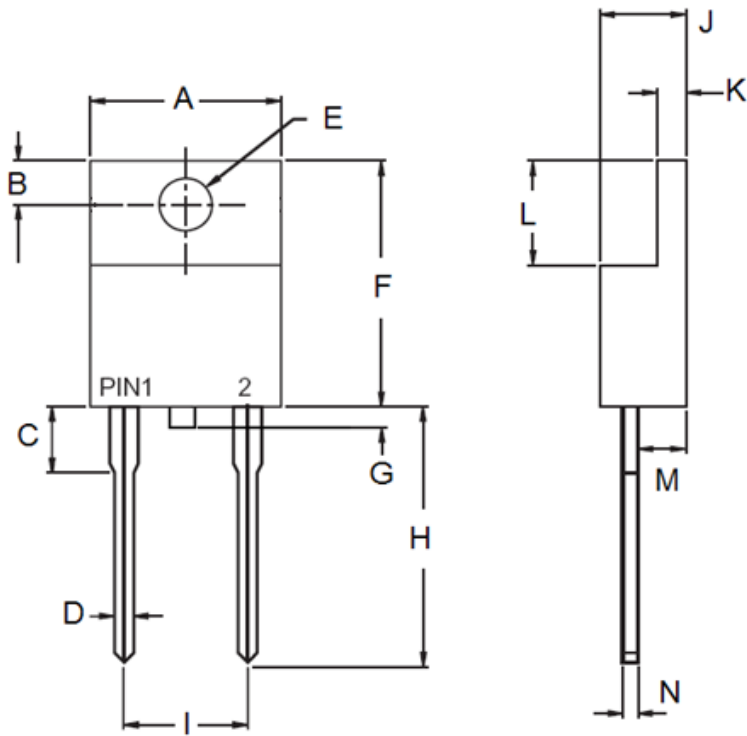

FIG.6 REVERSE RECOVERY TIME CHARACTERISTIC AND TEST CIRCUIT DIAGRAM



PACKAGE OUTLINE DIMENSIONS
TO-220AC



DIM.	Unit (mm)		Unit (inch)	
	Min	Max	Min	Max
A	-	10.50	-	0.413
B	2.62	3.44	0.103	0.135
C	2.80	4.20	0.110	0.165
D	0.68	0.94	0.027	0.037
E	3.54	4.00	0.139	0.157
F	14.60	16.00	0.575	0.630
G	0.00	1.60	0.000	0.063
H	13.19	14.79	0.519	0.582
I	4.95	5.20	0.195	0.205
J	4.42	4.76	0.174	0.187
K	1.14	1.40	0.045	0.055
L	5.84	6.86	0.230	0.270
M	2.20	2.80	0.087	0.110
N	0.35	0.64	0.014	0.025

MARKING DIAGRAM



- P/N = Marking Code
- G = Green Compound
- YW = Date Code
- F = Factory Code

Notice

Specifications of the products displayed herein are subject to change without notice. TSC or anyone on its behalf, assumes no responsibility or liability for any errors or inaccuracies.

Information contained herein is intended to provide a product description only. No license, express or implied, to any intellectual property rights is granted by this document. Except as provided in TSC's terms and conditions of sale for such products, TSC assumes no liability whatsoever, and disclaims any express or implied warranty, relating to sale and/or use of TSC products including liability or warranties relating to fitness for a particular purpose, merchantability, or infringement of any patent, copyright, or other intellectual property right.

The products shown herein are not designed for use in medical, life-saving, or life-sustaining applications. Customers using or selling these products for use in such applications do so at their own risk and agree to fully indemnify TSC for any damages resulting from such improper use or sale.