

MAX2657/MAX2658

GPS/GNSS Low-Noise Amplifiers

General Description

The MAX2657/MAX2658 high-gain, low-noise amplifiers (LNAs) are designed for GPS L1, Galileo, and GLONASS applications. Designed in Maxim's advanced SiGe process, the devices achieve a high gain and an ultra-low-noise figure while maximizing the input-referred 1dB compression point and the 3rd-order intercept point.

The MAX2657/MAX2658 operate from a +1.6V to +3.3V single supply. The MAX2657 is optimized for low current. The MAX2658 is optimized for high linearity. The shut-down feature in the device reduces the supply current to be less than 1 μ A. The MAX2657/MAX2658 are available in a very small, lead-free, RoHS-compliant, 0.86mm x 1.26mm x 0.65mm, wafer-level package (WLP).

Applications

- Location-Enabled Mobile Devices
- Telematics (Asset Tracking and Management)
- Personal Navigation Devices (PNDs)
- Cellular Phones with GPS
- Notebook PCs/Ultra-Mobile PCs
- Recreational, Marine Navigation
- Avionics
- Watches

Features

- High-Power Gain: 19dB (MAX2657)
- Ultra-Low-Noise Figure: 0.8dB
- Integrated 50 Ω Output Matching Circuit
- Low Supply Current: 4.1mA (MAX2657)
- Wide Supply Voltage Range: 1.6V to 3.3V
- Low Bill of Materials: One Inductor, Two Capacitors
- Small Footprint: 0.86mm x 1.26mm
- Thin Profile: 0.65mm
- 0.4mm-Pitch Wafer-Level Package (WLP)

Ordering Information

| PART | TEMP RANGE | PIN-PACKAGE |
|--------------|----------------|-------------|
| MAX2657EWT+T | -40°C to +85°C | 6 WLP |
| MAX2658EWT+T | -40°C to +85°C | 6 WLP |

+Denotes a lead(Pb)-free/RoHS-compliant package.
T = Tape and reel.

Pin Configuration/Typical Application Circuit

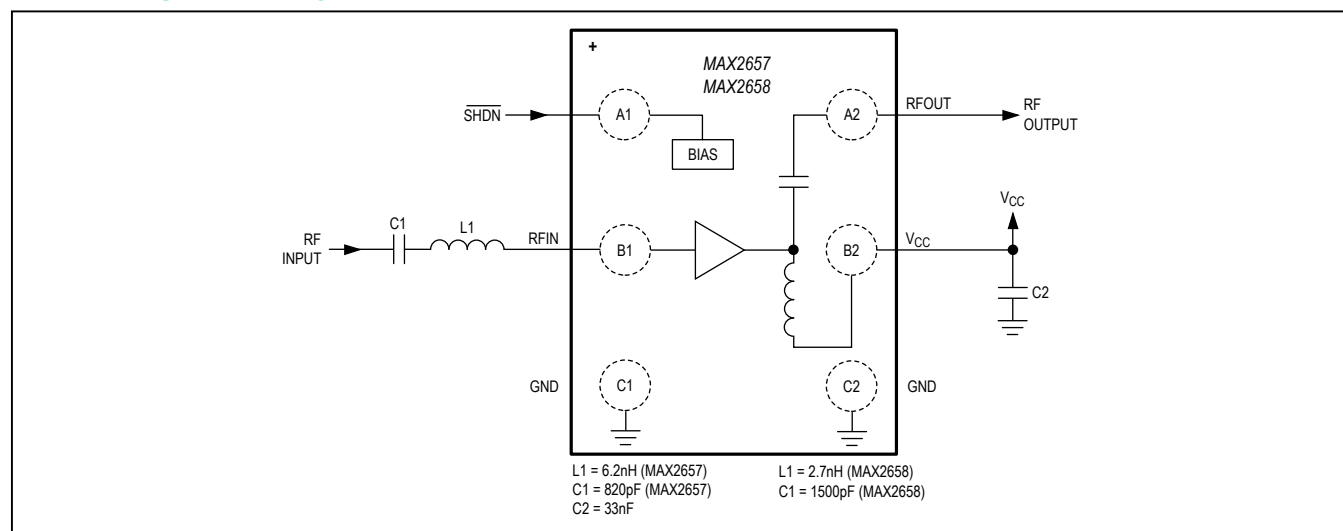

Absolute Maximum Ratings

| | | | |
|---|---|---|-------------------------|
| V _{CC} to GND | -0.3V to +3.6V | Maximum Current into RF Input | 10mA |
| Other Pins to GND | -0.3V to (+ Operating V _{CC} + 0.3V) | Operating Temperature Range | -40°C to +85°C |
| Maximum RF Input Power | +5dBm | Junction Temperature | +150°C |
| Continuous Power Dissipation (T _A = +70°C) | | Storage Temperature Range | -65°C to +160°C |
| 6-Bump WLP (derates 10.5mW/°C above +70°C) | 840mW | Lead Temperature (soldering, 10s) | Reflow Profile (Note 1) |

Note 1: Refer to Application Note 1891: *Wafer-Level Packaging (WLP) and Its Applications*.

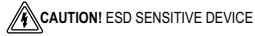

Stresses beyond those listed under "Absolute Maximum Ratings" may cause permanent damage to the device. These are stress ratings only, and functional operation of the device at these or any other conditions beyond those indicated in the operational sections of the specifications is not implied. Exposure to absolute maximum rating conditions for extended periods may affect device reliability.

DC Electrical Characteristics

(MAX2657/MAX2658 EV kit. V_{CC} = 1.6V to 3.3V, T_A = -40°C to +85°C, no RF signals are applied. Typical values are at V_{CC} = 2.85V and T_A = +25°C, unless otherwise noted.) (Note 2)

| PARAMETER | CONDITIONS | | MIN | TYP | MAX | UNITS |
|--------------------------|---------------------------|---------|-----|------|------|-------|
| Supply Voltage | | | 1.6 | 2.85 | 3.3 | V |
| Supply Current | SHDN = high | MAX2657 | 4.1 | | | mA |
| | | MAX2658 | 7.7 | | | |
| | Shutdown mode, SHDN = low | | | | 1 | µA |
| Digital Input Logic-High | | | 1.2 | | | V |
| Digital Input Logic-Low | | | | | 0.45 | V |
| Digital Input Current | | | | | 1 | µA |

AC Electrical Characteristics

(MAX2657/MAX2658 EV kit. V_{CC} = 1.6V to 3.3V, T_A = -40°C to +85°C, f_{RFIN} = 1575.42MHz. Typical values are at V_{CC} = 2.85V and T_A = +25°C, unless otherwise noted.) (Note 2)

| PARAMETER | CONDITIONS | | MIN | TYP | MAX | UNITS |
|---|-------------------------|---------|---------|-----|-----|-------|
| RF Frequency | L1 band | | 1575.42 | | | MHz |
| Power Gain | V _{CC} = 2.85V | MAX2657 | 19.5 | | | dB |
| | | MAX2658 | 17.7 | | | |
| | V _{CC} = 1.6V | MAX2657 | 19.4 | | | |
| | | MAX2658 | 17.6 | | | |
| Noise Figure | V _{CC} = 1.8V | | 0.8 | | | dB |
| | V _{CC} = 3.3V | | 0.8 | | | |
| In-Band 3rd-Order Input Intercept Point | (Note 3) | MAX2657 | -3.5 | | | dBm |
| | | MAX2658 | +4.5 | | | |
| Out-of-Band 3rd-Order Input Intercept Point | (Note 4) | MAX2657 | +2.5 | | | dBm |
| | | MAX2658 | +8 | | | |

AC Electrical Characteristics (continued)

(MAX2657/MAX2658 EV kit. $V_{CC} = 1.6V$ to $3.3V$, $T_A = -40^{\circ}C$ to $+85^{\circ}C$, $f_{RFIN} = 1575.42MHz$. Typical values are at $V_{CC} = 2.85V$ and $T_A = +25^{\circ}C$, unless otherwise noted.) (Note 2)

| PARAMETER | CONDITIONS | MIN | TYP | MAX | UNITS |
|-----------------------------|------------|---------|-------|-----|-------|
| Input 1dB Compression point | (Note 5) | MAX2657 | -12.5 | | dBm |
| | | MAX2658 | -10 | | |
| Input Return Loss | | | 10 | | dB |
| Output Return Loss | | | 15 | | dB |
| Reverse Isolation | | | 30 | | dB |

- Note 2:** Min and max limits guaranteed by test at $T_A = +85^{\circ}C$ and guaranteed by design and characterization at $T_A = -40^{\circ}C$ and $T_A = +25^{\circ}C$.
- Note 3:** Measured with the two tones located at 1MHz and 2MHz offset from the center of the GPS band with -30dBm/tone for MAX2657 and -27dBm/tone for MAX2658.
- Note 4:** Measured with input tones at 1713MHz (-25dBm) and 1851MHz (-49dBm).
- Note 5:** Measured with a tone located at 5MHz offset from the center of the GPS band.

Typical Operating Characteristics

(MAX2657/MAX2658 EV kit. Typical values are at $V_{CC} = 2.85V$, $T_A = +25^{\circ}C$, and $f_{RFIN} = 1575.42MHz$, unless otherwise noted.)

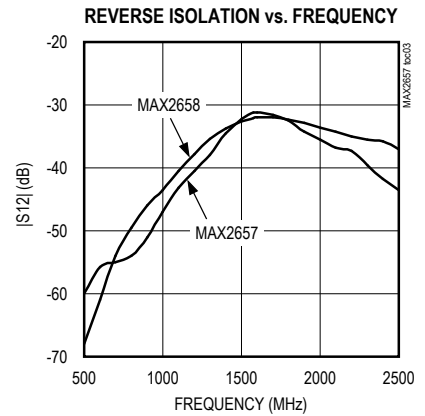
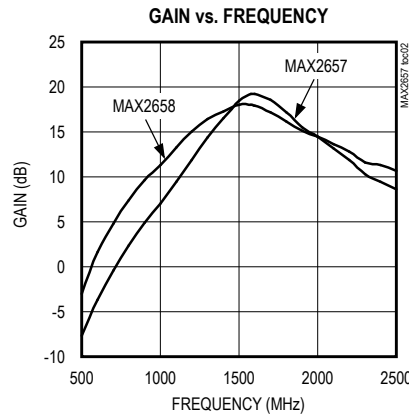
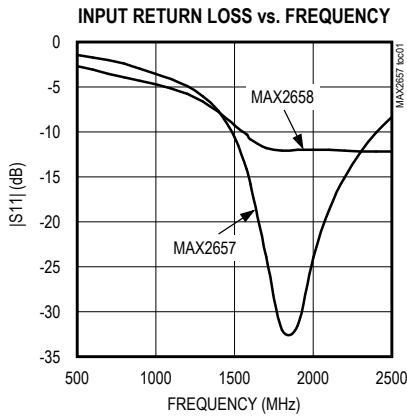

Typical Operating Characteristics (continued)

(MAX2657/MAX2658 EV kit. Typical values are at $V_{CC} = 2.85V$, $T_A = +25^\circ C$, and $f_{RFIN} = 1575.42MHz$, unless otherwise noted.)

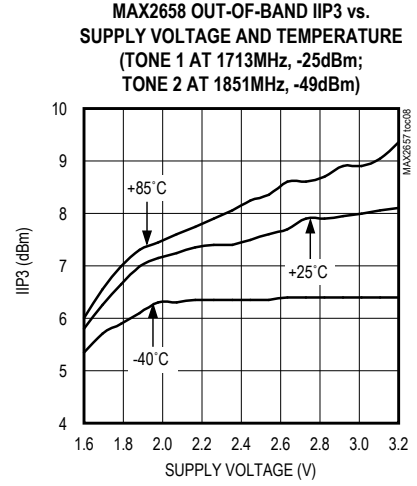
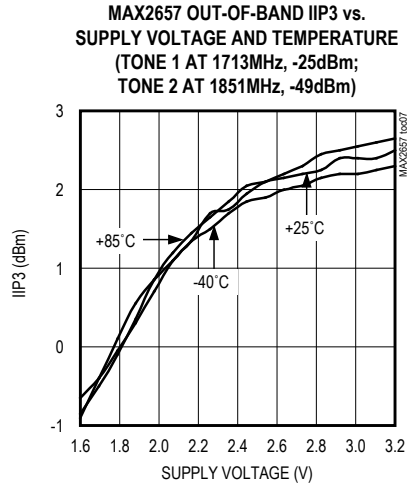
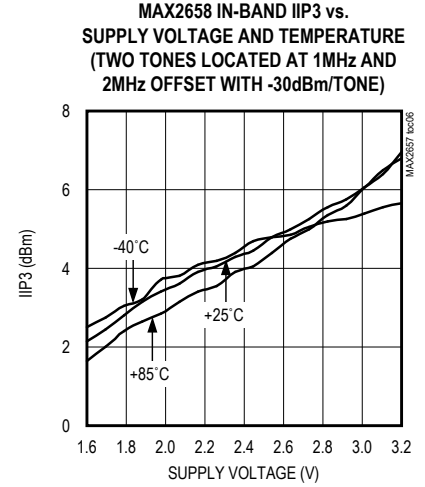
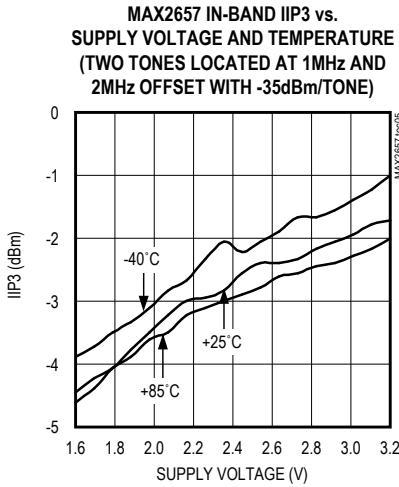
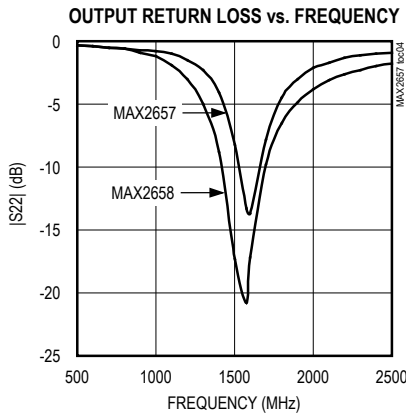

Typical Operating Characteristics (continued)

(MAX2657/MAX2658 EV kit. Typical values are at $V_{CC} = 2.85V$, $T_A = +25^\circ C$, and $f_{RFIN} = 1575.42MHz$, unless otherwise noted.)

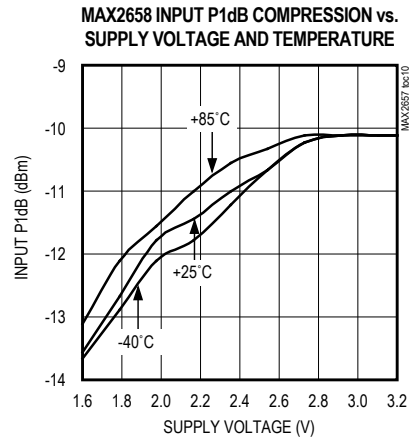
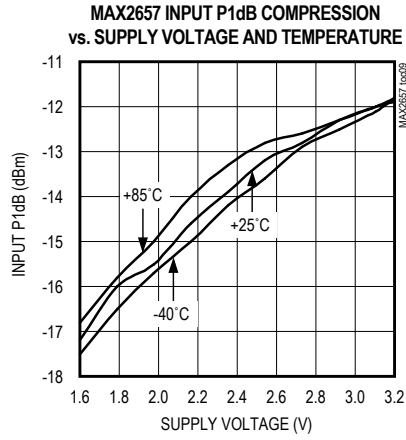

Pin Description

| BUMP | NAME | FUNCTION |
|--------|--------------------------|---|
| A1 | $\overline{\text{SHDN}}$ | Shutdown Input. A logic-low disables the device. |
| A2 | RFOUT | RF Output. RFOUT is internally matched to 50 Ω and incorporates an internal DC-blocking capacitor. |
| B1 | RFIN | RF Input. Requires a DC-blocking capacitor and external matching components. |
| B2 | V _{CC} | Supply Voltage. Bypass to ground with a 33nF capacitor as close as possible to the IC. |
| C1, C2 | GND | Ground. Connect to the PCB ground plane. |

Detailed Description

The MAX2657/MAX2658 are LNAs designed for GPS L1, Galileo, and GLONASS applications. The devices feature a power-shutdown control mode to eliminate the need for an external supply switch. The devices achieve a high gain and an ultra-low-noise figure.

Input and Output Matching

The MAX2657/MAX2658 require an off-chip input matching. Only an inductor in series with a DC-blocking capacitor is needed to form the input matching circuit. The *Typical Application Circuit* shows the recommended input-matching network. These values are optimized for the best simultaneous gain, noise figure, and return loss performance. Tables 1 and 2 list typical device S parameters and K_f values. The MAX2657/MAX2658 integrate an on-chip output matching to 50 Ω at the output, eliminating the need for external matching components. The value of the input coupling capacitor affects IIP3. A smaller coupling capacitor results in lower IIP3.

Shutdown

The MAX2657/MAX2658 include a shutdown feature to turn off the entire chip. Apply a logic-high to the $\overline{\text{SHDN}}$ pin to place the part in the active mode, and a logic-low to place the part in the shutdown mode.

Applications Information

A properly designed PCB is essential to any RF microwave circuit. Use controlled-impedance lines on all high-frequency inputs and outputs. Bypass V_{CC} with decoupling capacitors located close to the device. For long V_{CC} lines, it may be necessary to add decoupling capacitors. Locate these additional capacitors further away from the device package. Proper grounding of the GND pins is essential. If the PCB uses a topside RF ground, connect it directly to the GND pins. For a board where the ground is not on the component layer, connect the GND pins to the board with multiple vias close to the package.

Table 1. MAX2657 Typical S-Parameter Values and K-Factor

| FREQ. (MHz) | S11 MAG (dB) | S11 PHASE (Degrees) | S21 MAG (dB) | S21 PHASE (Degrees) | S12 MAG (dB) | S12 PHASE (Degrees) | S22 MAG (dB) | S22 PHASE (Degrees) | K _f |
|-------------|--------------|---------------------|--------------|---------------------|--------------|---------------------|--------------|---------------------|----------------|
| 1000 | -2.0 | -47.7 | 6.0 | -100.0 | -47.5 | -148.0 | -1.0 | -55.0 | 5.1 |
| 1100 | -2.1 | -48.6 | 7.4 | -100.6 | -45.7 | -150.0 | -1.0 | -58.1 | 3.8 |
| 1200 | -2.2 | -51.6 | 9.6 | -107.3 | -42.9 | -153.5 | -1.4 | -65.4 | 3.1 |
| 1300 | -2.4 | -55.0 | 12.0 | -117.2 | -39.6 | -160.2 | -2.1 | -74.1 | 2.5 |
| 1400 | -2.7 | -58.6 | 14.0 | -129.5 | -37.0 | -168.5 | -3.6 | -85.5 | 2.3 |
| 1500 | -6.5 | -61.9 | 16.2 | -146.5 | -34.1 | 178.5 | -7.4 | -100.0 | 2.8 |
| 1575 | -4.3 | -62.3 | 17.1 | -164.2 | -32.9 | 162.8 | -15.3 | -100.8 | 2.1 |
| 1600 | -4.6 | -61.6 | 17.3 | -170.6 | -32.8 | 156.6 | -20.6 | -78.9 | 2.0 |
| 1700 | -5.4 | -55.3 | 17.1 | 165.5 | -32.5 | 136.5 | -9.5 | 10.0 | 1.8 |
| 1800 | -5.2 | -49.8 | 15.7 | 145.8 | -33.8 | 121.6 | -4.5 | -2.4 | 1.6 |
| 1900 | -4.8 | -47.3 | 13.9 | 135.2 | -35.2 | 113.8 | -2.7 | -13.2 | 1.6 |
| 2000 | -4.5 | -46.7 | 12.7 | 127.3 | -36.7 | 109.6 | -1.8 | -21.2 | 1.5 |

Table 2. MAX2658 Typical S-Parameter Values and K-Factor

| FREQ. (MHz) | S11 MAG (dB) | S11 PHASE (Degrees) | S21 MAG (dB) | S21 PHASE (Degrees) | S12 MAG (dB) | S12 PHASE (Degrees) | S22 MAG (dB) | S22 PHASE (Degrees) | K _f |
|-------------|--------------|---------------------|--------------|---------------------|--------------|---------------------|--------------|---------------------|----------------|
| 1000 | -3.0 | -57.0 | 10.8 | -120.0 | -43.0 | -154.0 | -1.3 | -65.0 | 3.2 |
| 1100 | -3.3 | -58.2 | 11.6 | -124.5 | -42.1 | -155.0 | -1.6 | -70.2 | 3.3 |
| 1200 | -3.5 | -60.0 | 13.4 | -134.6 | -39.3 | -160.5 | -2.4 | -79.6 | 2.8 |
| 1300 | -3.8 | -62.3 | 14.9 | -148.0 | -37.2 | -168.3 | -4.0 | -90.0 | 2.7 |
| 1400 | -4.3 | -63.3 | 15.9 | -162.3 | -35.4 | -178.2 | -7.3 | -101.0 | 2.7 |
| 1500 | -4.9 | -62.0 | 16.6 | -178.9 | -33.9 | 171.0 | -14.5 | -100.6 | 2.6 |
| 1575 | -5.3 | -59.7 | 16.6 | 168.0 | -33.5 | 161.7 | -19.6 | -26.0 | 2.5 |
| 1600 | -5.4 | -58.5 | 16.5 | 163.9 | -33.6 | 157.5 | -16.7 | -6.0 | 2.5 |
| 1700 | -5.5 | -53.7 | 15.8 | 149.3 | -33.6 | 148.3 | -9.0 | 3.6 | 2.3 |
| 1800 | -5.3 | -50.3 | 14.7 | 136.8 | -34.2 | 142.5 | -5.7 | -2.8 | 2.2 |
| 1900 | -5.1 | -48.0 | 13.4 | 130.0 | -35.1 | 139.6 | -4.0 | -9.6 | 2.3 |
| 2000 | -4.9 | -46.3 | 12.7 | 123.9 | -35.8 | 138.6 | -3.0 | -15.0 | 2.1 |

Table 3. MAX2657 Typical Noise Parameters (V_{CC} = 2.85V, T_A = +25°C)

| FREQUENCY (MHz) | FMIN (dB) | Γ _{OPT} | Γ _{OPT} ANGLE | R _N (Ω) |
|-----------------|-----------|------------------|--------------------------|--------------------|
| 1550 | 0.68 | 0.44 | 47.7 | 8.39 |
| 1560 | 0.68 | 0.44 | 48.1 | 8.38 |
| 1570 | 0.68 | 0.44 | 48.3 | 8.37 |
| 1575 | 0.68 | 0.44 | 48.5 | 8.36 |
| 1580 | 0.68 | 0.44 | 48.6 | 8.36 |
| 1590 | 0.68 | 0.44 | 48.9 | 8.35 |
| 1600 | 0.68 | 0.44 | 49.2 | 8.34 |

Table 4. MAX2658 Typical Noise Parameters (V_{CC} = 2.85V, T_A = +25°C)

| FREQUENCY (MHz) | FMIN (dB) | Γ _{OPT} | Γ _{OPT} ANGLE | R _N (Ω) |
|-----------------|-----------|------------------|--------------------------|--------------------|
| 1550 | 0.68 | 0.28 | 88.0 | 4.48 |
| 1560 | 0.68 | 0.28 | 88.4 | 4.48 |
| 1570 | 0.68 | 0.28 | 88.8 | 4.48 |
| 1575 | 0.68 | 0.28 | 89.0 | 4.48 |
| 1580 | 0.68 | 0.28 | 89.2 | 4.48 |
| 1590 | 0.69 | 0.28 | 89.6 | 4.47 |
| 1600 | 0.69 | 0.28 | 90.0 | 4.47 |

Chip Information

PROCESS: SiGe BiCMOS

Package Information

For the latest package outline information and land patterns (footprints), go to www.maximintegrated.com/packages. Note that a "+", "#", or "-" in the package code indicates RoHS status only. Package drawings may show a different suffix character, but the drawing pertains to the package regardless of RoHS status.

| PACKAGE TYPE | PACKAGE CODE | OUTLINE NO. | LAND PATTERN NO. |
|--------------|--------------|-------------------------|-------------------------|
| 6 WLP | W61B1+1 | 21-0217 | 90-0226 |

Revision History

| REVISION NUMBER | REVISION DATE | DESCRIPTION | PAGES CHANGED |
|-----------------|---------------|-----------------------------|---------------|
| 0 | 9/09 | Initial release | — |
| 1 | 4/14 | Updated <i>Applications</i> | 1 |

For pricing, delivery, and ordering information, please contact Maxim Direct at 1-888-629-4642, or visit Maxim Integrated's website at www.maximintegrated.com.

Maxim Integrated cannot assume responsibility for use of any circuitry other than circuitry entirely embodied in a Maxim Integrated product. No circuit patent licenses are implied. Maxim Integrated reserves the right to change the circuitry and specifications without notice at any time. The parametric values (min and max limits) shown in the Electrical Characteristics table are guaranteed. Other parametric values quoted in this data sheet are provided for guidance.