



# SOT23, 1.8V, Nanopower, Beyond-the-Rails Comparators With/Without Reference

**MAX917-MAX920**

## General Description

The MAX917-MAX920 nanopower comparators in space-saving SOT23 packages feature Beyond-the-Rails™ inputs and are guaranteed to operate down to +1.8V. The MAX917/MAX918 feature an on-board 1.245V  $\pm$ 1.5% reference and draw an ultra-low supply current of only 750nA, while the MAX919/MAX920 (without reference) require just 380nA of supply current. These features make the MAX917-MAX920 family of comparators ideal for all 2-cell battery applications, including monitoring/management.

The unique design of the output stage limits supply-current surges while switching, virtually eliminating the supply glitches typical of many other comparators. This design also minimizes overall power consumption under dynamic conditions. The MAX917/MAX919 have a push-pull output stage that sinks and sources current. Large internal output drivers allow rail-to-rail output swing with loads up to 8mA. The MAX918/MAX920 have an open-drain output stage that makes them suitable for mixed-voltage system design.

## Applications

- 2-Cell Battery Monitoring/Management
- Ultra-Low-Power Systems
- Mobile Communications
- Notebooks and PDAs
- Threshold Detectors/Discriminators
- Sensing at Ground or Supply Line
- Telemetry and Remote Systems
- Medical Instruments

## Selector Guide

PART	INTERNAL REFERENCE	OUTPUT TYPE	SUPPLY CURRENT (nA)
MAX917	Yes	Push-Pull	750
MAX918	Yes	Open-Drain	750
MAX919	No	Push-Pull	380
MAX920	No	Open-Drain	380

Typical Application Circuit appears at end of data sheet.

Beyond-the-Rails is a trademark of Maxim Integrated Products, Inc.



For pricing, delivery, and ordering information, please contact Maxim Direct at 1-888-629-4642, or visit Maxim's website at [www.maxim-ic.com](http://www.maxim-ic.com).

## Features

- ◆ Ultra-Low Supply Current  
380nA per Comparator (MAX919/MAX920)  
750nA per Comparator with Reference (MAX917/MAX918)
- ◆ Guaranteed to Operate Down to +1.8V
- ◆ Internal 1.245V  $\pm$ 1.5% Reference (MAX917/MAX918)
- ◆ Input Voltage Range Extends 200mV Beyond-the-Rails
- ◆ CMOS Push-Pull Output with  $\pm$ 8mA Drive Capability (MAX917/MAX919)
- ◆ Open-Drain Output Versions Available (MAX918/MAX920)
- ◆ Crowbar-Current-Free Switching
- ◆ Internal Hysteresis for Clean Switching
- ◆ No Phase Reversal for Overdriven Inputs
- ◆ Space-Saving SOT23 Package

## Ordering Information

PART	PIN-PACKAGE	TOP MARK	PKG CODE
MAX917EUK+T	5 SOT23	ADIQ	U5+1
MAX917ESA+	8 SO	—	S8+2
MAX918EUK+T	5 SOT23	ADIR	U5+1
MAX918ESA+	8 SO	—	S8+2
MAX919EUK+T	5 SOT23	ADIS	U5+1
MAX919EUK/V+T	5 SOT23	AFGP	U5+1
MAX919ESA+	8 SO	—	S8+2
MAX920EUK+T	5 SOT23	ADIT	U5+1
MAX920ESA+	8 SO	—	S8+2

Note: All devices are specified over the -40°C to +85°C operating temperature range.

+ Denotes a lead(Pb)-free/RoHS-compliant package.

V denotes an automotive qualified part.

## Pin Configurations

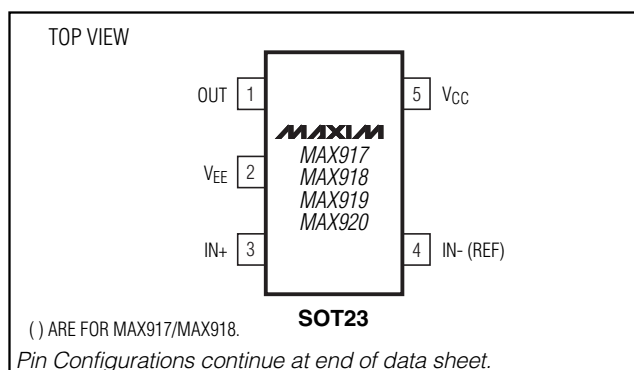

# SOT23, 1.8V, Nanopower, Beyond-the-Rails Comparators With/Without Reference

## ABSOLUTE MAXIMUM RATINGS

Supply Voltage ( $V_{CC}$ to $V_{EE}$ ).....	+6V	Continuous Power Dissipation ( $T_A = +70^\circ\text{C}$ )	
Voltage Inputs ( $IN+$ , $IN-$ , REF) .....	( $V_{EE} - 0.3\text{V}$ ) to ( $V_{CC} + 0.3\text{V}$ )	5-Pin SOT23 (derate 7.31mW/ $^\circ\text{C}$ above $+70^\circ\text{C}$ ).....	571mW
Current Into Input Pins .....	$\pm 20\text{mA}$	8-Pin SO (derate 5.88mW/ $^\circ\text{C}$ above $+70^\circ\text{C}$ ).....	471mW
Output Voltage		Operating Temperature Range .....	$-40^\circ\text{C}$ to $+85^\circ\text{C}$
MAX917/MAX919 .....	( $V_{EE} - 0.3\text{V}$ ) to ( $V_{CC} + 0.3\text{V}$ )	Storage Temperature Range .....	$-65^\circ\text{C}$ to $+150^\circ\text{C}$
MAX918/MAX920 .....	( $V_{EE} - 0.3\text{V}$ ) to $+6\text{V}$	Lead Temperature (soldering, 10s) .....	$+300^\circ\text{C}$
Output Current.....	$\pm 50\text{mA}$	Soldering Temperature (reflow) .....	$+260^\circ\text{C}$
Output Short-Circuit Duration .....	10sec		

Stresses beyond those listed under "Absolute Maximum Ratings" may cause permanent damage to the device. These are stress ratings only, and functional operation of the device at these or any other conditions beyond those indicated in the operational sections of the specifications is not implied. Exposure to absolute maximum rating conditions for extended periods may affect device reliability.

## ELECTRICAL CHARACTERISTICS—MAX917/MAX918

( $V_{CC} = +5\text{V}$ ,  $V_{EE} = 0\text{V}$ ,  $V_{IN+} = V_{REF}$ ,  $T_A = -40^\circ\text{C}$  to  $+85^\circ\text{C}$ , unless otherwise noted. Typical values are at  $T_A = +25^\circ\text{C}$ .) (Note 1)

PARAMETER	SYMBOL	CONDITIONS		MIN	TYP	MAX	UNITS
Supply Voltage Range	$V_{CC}$	Inferred from the PSRR test		1.8		5.5	V
Supply Current	$I_{CC}$	$V_{CC} = 1.8\text{V}$			0.75		$\mu\text{A}$
		$V_{CC} = 5\text{V}$	$T_A = +25^\circ\text{C}$		0.80	1.30	
			$T_A = T_{MIN}$ to $T_{MAX}$			1.60	
$IN+$ Voltage Range	$V_{IN+}$	Inferred from the output swing test		$V_{EE} - 0.2$		$V_{CC} + 0.2$	V
Input Offset Voltage	$V_{OS}$	(Note 2)	$T_A = +25^\circ\text{C}$		1	5	mV
			$T_A = T_{MIN}$ to $T_{MAX}$			10	
Input-Referred Hysteresis	$V_{HB}$	(Note 3)			4		mV
Input Bias Current	$I_B$	$T_A = +25^\circ\text{C}$			0.15	1	nA
		$T_A = T_{MIN}$ to $T_{MAX}$				2	
Power-Supply Rejection Ratio	PSRR	$V_{CC} = 1.8\text{V}$ to $5.5\text{V}$			0.1	1	mV/V
Output-Voltage Swing High	$V_{CC} - V_{OH}$	MAX917 only, $V_{CC} = 5\text{V}$ , $I_{SOURCE} = 8\text{mA}$	$T_A = +25^\circ\text{C}$		190	400	mV
			$T_A = T_{MIN}$ to $T_{MAX}$			500	
		MAX917 only, $V_{CC} = 1.8\text{V}$ , $I_{SOURCE} = 1\text{mA}$	$T_A = +25^\circ\text{C}$		55	200	
			$T_A = T_{MIN}$ to $T_{MAX}$			300	
Output-Voltage Swing Low	$V_{OL}$	$V_{CC} = 5\text{V}$ , $I_{SINK} = 8\text{mA}$	$T_A = +25^\circ\text{C}$		190	400	mV
			$T_A = T_{MIN}$ to $T_{MAX}$			500	
		$V_{CC} = 1.8\text{V}$ , $I_{SINK} = 1\text{mA}$	$T_A = +25^\circ\text{C}$		55	200	
			$T_A = T_{MIN}$ to $T_{MAX}$			300	
Output Leakage Current	$I_{LEAK}$	MAX918 only, $V_O = 5.5\text{V}$			0.001	1	$\mu\text{A}$
Output Short-Circuit Current	$I_{SC}$	Sourcing, $V_O = V_{EE}$	$V_{CC} = 5\text{V}$		95		mA
			$V_{CC} = 1.8\text{V}$		8		
		Sinking, $V_O = V_{CC}$	$V_{CC} = 5\text{V}$		98		
			$V_{CC} = 1.8\text{V}$		10		

# SOT23, 1.8V, Nanopower, Beyond-the-Rails Comparators With/Without Reference

MAX917-MAX920

## ELECTRICAL CHARACTERISTICS—MAX917/MAX918 (continued)

( $V_{CC} = +5V$ ,  $V_{EE} = 0V$ ,  $V_{IN+} = V_{REF}$ ,  $T_A = -40^{\circ}C$  to  $+85^{\circ}C$ , unless otherwise noted. Typical values are at  $T_A = +25^{\circ}C$ .) (Note 1)

PARAMETER	SYMBOL	CONDITIONS	MIN	TYP	MAX	UNITS
High-to-Low Propagation Delay (Note 4)	$t_{PD-}$	$V_{CC} = 1.8V$		17		$\mu s$
		$V_{CC} = 5V$		22		
Low-to-High Propagation Delay (Note 4)	$t_{PD+}$	MAX917 only	$V_{CC} = 1.8V$	30		$\mu s$
			$V_{CC} = 5V$	95		
		MAX918 only	$V_{CC} = 1.8V$ , $R_{PULLUP} = 100k\Omega$	35		
			$V_{CC} = 5V$ , $R_{PULLUP} = 100k\Omega$	120		
Rise Time	$t_{RISE}$	MAX917 only, $C_L = 15pF$		6		$\mu s$
Fall Time	$t_{FALL}$	$C_L = 15pF$		4		$\mu s$
Power-Up Time	$t_{ON}$			1.2		ms
Reference Voltage	$V_{REF}$	$T_A = +25^{\circ}C$	1.227	1.245	1.263	V
		$T_A = T_{MIN}$ to $T_{MAX}$	1.200		1.290	
Reference Voltage Temperature Coefficient	$T_{CREF}$			95		ppm/ $^{\circ}C$
Reference Output Voltage Noise	$e_n$	$BW = 10Hz$ to $100kHz$		600		$\mu V_{RMS}$
		$BW = 10Hz$ to $100kHz$ , $C_{REF} = 1nF$		215		
Reference Line Regulation	$\frac{\Delta V_{REF}}{\Delta V_{CC}}$	$1.8V \leq V_{CC} \leq 5.5V$		0.1		mV/V
Reference Load Regulation	$\frac{\Delta V_{REF}}{\Delta I_{OUT}}$	$\Delta I_{OUT} = 10nA$		$\pm 0.2$		mV/nA

## ELECTRICAL CHARACTERISTICS—MAX919/MAX920

( $V_{CC} = +5V$ ,  $V_{EE} = 0V$ ,  $V_{CM} = 0V$ ,  $T_A = -40^{\circ}C$  to  $+85^{\circ}C$ , unless otherwise noted. Typical values are at  $T_A = +25^{\circ}C$ .) (Note 1)

PARAMETER	SYMBOL	CONDITIONS	MIN	TYP	MAX	UNITS
Supply Voltage Range	$V_{CC}$	Inferred from the PSRR test	1.8		5.5	V
Supply Current	$I_{CC}$	$V_{CC} = 1.8V$		0.38		$\mu A$
		$V_{CC} = 5V$	$T_A = +25^{\circ}C$	0.45	0.80	
			$T_A = T_{MIN}$ to $T_{MAX}$		1.2	
Input Common-Mode Voltage Range	$V_{CM}$	Inferred from the CMRR test	$V_{EE} - 0.2$		$V_{CC} + 0.2$	V
Input Offset Voltage	$V_{OS}$	$-0.2V \leq V_{CM} \leq (V_{CC} + 0.2V)$ (Note 2)	$T_A = +25^{\circ}C$	1	5	mV
			$T_A = T_{MIN}$ to $T_{MAX}$		10	
Input-Referred Hysteresis	$V_{HB}$	$-0.2V \leq V_{CM} \leq (V_{CC} + 0.2V)$ (Note 3)		4		mV
Input Bias Current	$I_B$	$T_A = +25^{\circ}C$		0.15	1	nA
		$T_A = T_{MIN}$ to $T_{MAX}$			2	

# SOT23, 1.8V, Nanopower, Beyond-the-Rails Comparators With/Without Reference

## ELECTRICAL CHARACTERISTICS—MAX919/MAX920 (continued)

( $V_{CC} = +5V$ ,  $V_{EE} = 0V$ ,  $V_{CM} = 0V$ ,  $T_A = -40^{\circ}C$  to  $+85^{\circ}C$ , unless otherwise noted. Typical values are at  $T_A = +25^{\circ}C$ .) (Note 1)

PARAMETER	SYMBOL	CONDITIONS	MIN	TYP	MAX	UNITS
Input Offset Current	$I_{OS}$			10		pA
Power-Supply Rejection Ratio	PSRR	$V_{CC} = 1.8V$ to $5.5V$		0.1	1	mV/V
Common-Mode Rejection Ratio	CMRR	$(V_{EE} - 0.2V) \leq V_{CM} \leq (V_{CC} + 0.2V)$		0.5	3	mV/V
Output-Voltage Swing High	$V_{CC} - V_{OH}$	MAX919 only, $V_{CC} = 5V$ , $I_{SOURCE} = 8mA$	$T_A = +25^{\circ}C$	190	400	mV
			$T_A = T_{MIN}$ to $T_{MAX}$		500	
		MAX919 only, $V_{CC} = 1.8V$ , $I_{SOURCE} = 1mA$	$T_A = +25^{\circ}C$	55	200	
			$T_A = T_{MIN}$ to $T_{MAX}$		300	
Output-Voltage Swing Low	$V_{OL}$	$V_{CC} = 5V$ , $I_{SINK} = 8mA$	$T_A = +25^{\circ}C$	190	400	mV
			$T_A = T_{MIN}$ to $T_{MAX}$		500	
		$V_{CC} = 1.8V$ , $I_{SINK} = 1mA$	$T_A = +25^{\circ}C$	55	200	
			$T_A = T_{MIN}$ to $T_{MAX}$		300	
Output Leakage Current	$I_{LEAK}$	MAX920 only, $V_O = 5.5V$		0.001	1	$\mu A$
Output Short-Circuit Current	$I_{SC}$	Sourcing, $V_O = V_{EE}$	$V_{CC} = 5V$	95		mA
			$V_{CC} = 1.8V$	8		
		Sinking, $V_O = V_{CC}$	$V_{CC} = 5V$	98		
			$V_{CC} = 1.8V$	10		
High-to-Low Propagation Delay (Note 4)	$t_{PD-}$		$V_{CC} = 1.8V$	17		$\mu s$
			$V_{CC} = 5V$	22		
Low-to-High Propagation Delay (Note 4)	$t_{PD+}$	MAX919 only	$V_{CC} = 1.8V$	30		$\mu s$
			$V_{CC} = 5V$	95		
		MAX920 only	$V_{CC} = 1.8V$ $R_{PULLUP} = 100k\Omega$	35		
			$V_{CC} = 5V$ $R_{PULLUP} = 100k\Omega$	120		
Rise Time	$t_{RISE}$	MAX919 only, $C_L = 15pF$		6		$\mu s$
Fall Time	$t_{FALL}$	$C_L = 15pF$		4		$\mu s$
Power-Up Time	$t_{ON}$			1.2		ms

**Note 1:** All specifications are 100% tested at  $T_A = +25^{\circ}C$ . Specification limits over temperature ( $T_A = T_{MIN}$  to  $T_{MAX}$ ) are guaranteed by design, not production tested.

**Note 2:**  $V_{OS}$  is defined as the center of the hysteresis band at the input.

**Note 3:** The hysteresis-related trip points are defined as the edges of the hysteresis band, measured with respect to the center of the band (i.e.,  $V_{OS}$ ) (Figure 2).

**Note 4:** Specified with an input overdrive ( $V_{OVERDRIVE}$ ) of 100mV, and load capacitance of  $C_L = 15pF$ .  $V_{OVERDRIVE}$  is defined above and beyond the offset voltage and hysteresis of the comparator input. For the MAX917/MAX918, reference voltage error should also be added.

# SOT23, 1.8V, Nanopower, Beyond-the-Rails Comparators With/Without Reference

## Typical Operating Characteristics

( $V_{CC} = +5V$ ,  $V_{EE} = 0V$ ,  $C_L = 15pF$ ,  $V_{OVERDRIVE} = 100mV$ ,  $T_A = +25^\circ C$ , unless otherwise noted.)

MAX917-MAX920

**MAX917/MAX918**  
SUPPLY CURRENT vs.  
SUPPLY VOLTAGE AND TEMPERATURE

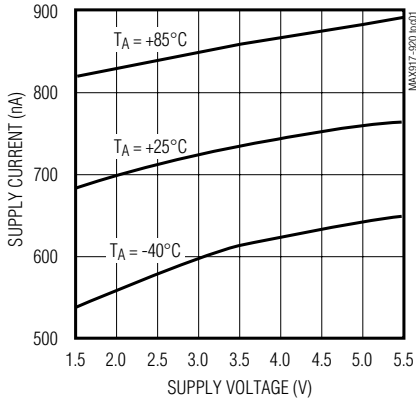

**MAX919/MAX920**  
SUPPLY CURRENT vs.  
SUPPLY VOLTAGE AND TEMPERATURE

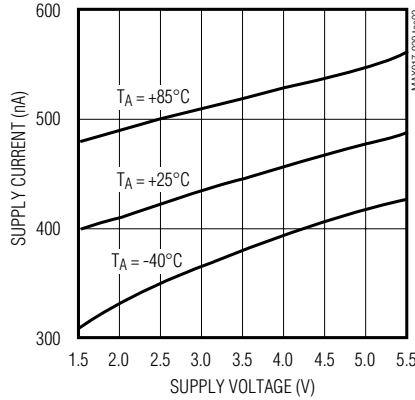

**MAX917/MAX918**  
SUPPLY CURRENT vs. TEMPERATURE

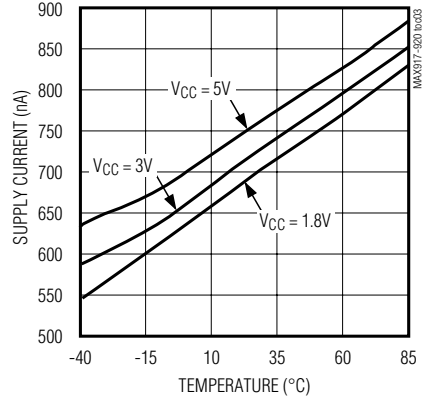

**MAX919/MAX920**  
SUPPLY CURRENT vs. TEMPERATURE

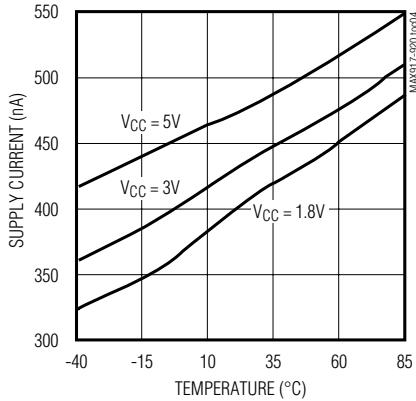

**MAX917/MAX918**  
SUPPLY CURRENT vs.  
OUTPUT TRANSITION FREQUENCY

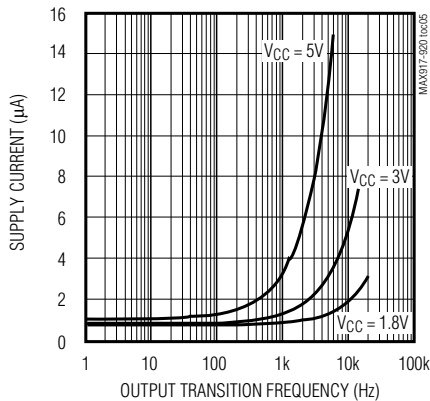

**MAX919/MAX920**  
SUPPLY CURRENT vs.  
OUTPUT TRANSITION FREQUENCY

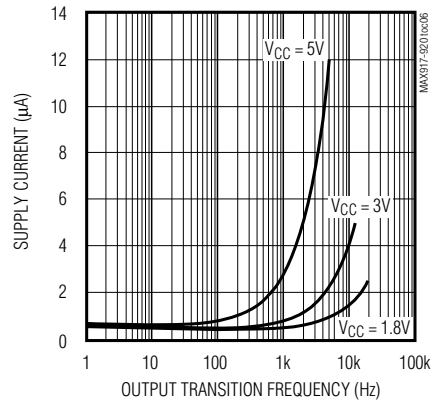

**OUTPUT-VOLTAGE LOW vs. SINK CURRENT**

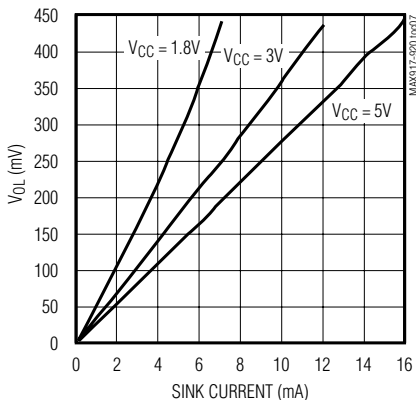

**OUTPUT-VOLTAGE LOW vs. SINK CURRENT AND TEMPERATURE**

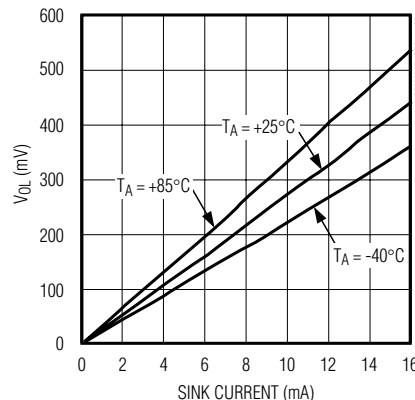

**MAX917/MAX919**  
OUTPUT-VOLTAGE HIGH vs. SOURCE CURRENT

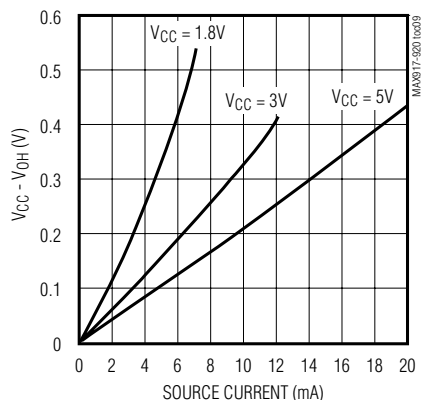

# SOT23, 1.8V, Nanopower, Beyond-the-Rails Comparators With/Without Reference

## Typical Operating Characteristics (continued)

( $V_{CC} = +5V$ ,  $V_{EE} = 0V$ ,  $C_L = 15pF$ ,  $V_{OVERDRIVE} = 100mV$ ,  $T_A = +25^\circ C$ , unless otherwise noted.)

**MAX917/MAX919  
OUTPUT-VOLTAGE HIGH vs.  
SOURCE CURRENT AND TEMPERATURE**

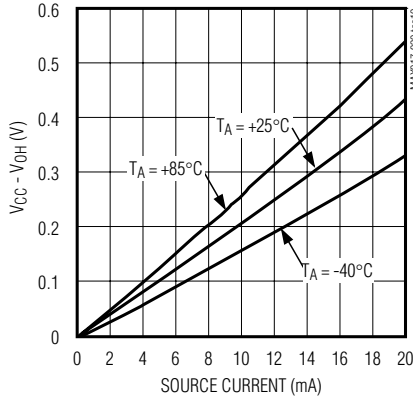

**SHORT-CIRCUIT SINK CURRENT  
vs. TEMPERATURE**

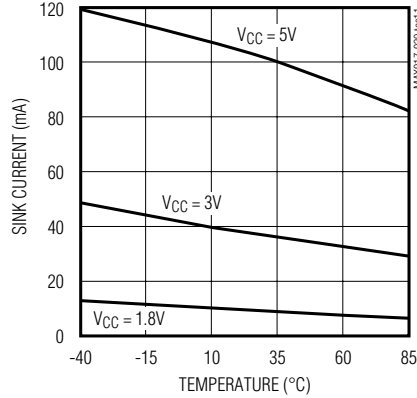

**MAX917/MAX919  
SHORT-CIRCUIT SOURCE CURRENT  
vs. TEMPERATURE**

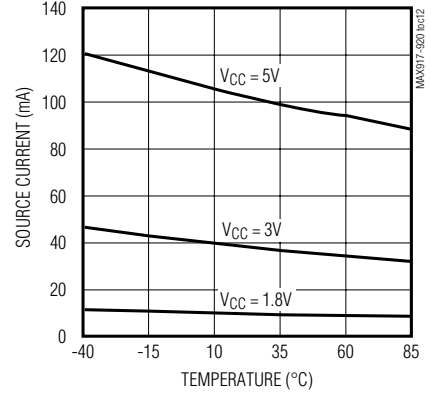

**OFFSET VOLTAGE vs. TEMPERATURE**

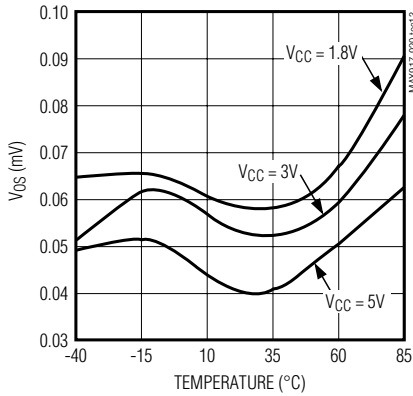

**HYSTERESIS VOLTAGE vs. TEMPERATURE**

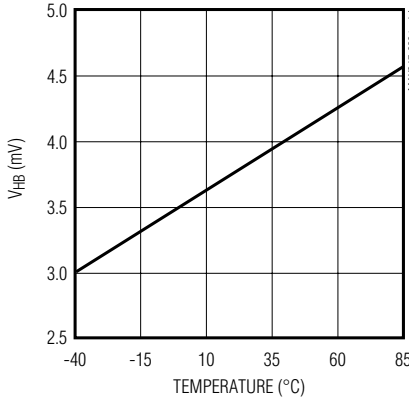

**MAX917/MAX918  
REFERENCE VOLTAGE vs. TEMPERATURE**

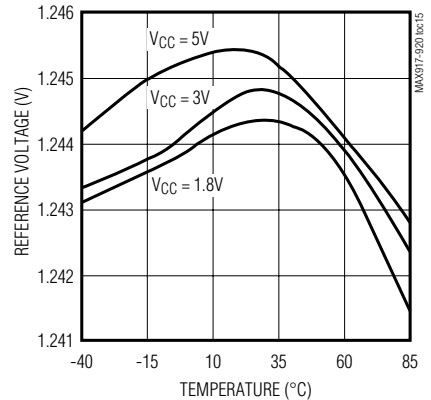

**MAX917/MAX918  
REFERENCE VOLTAGE vs.  
SUPPLY VOLTAGE**

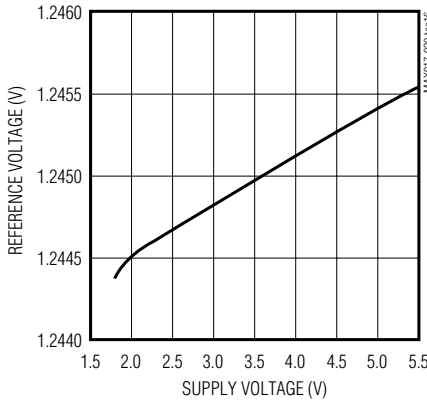

**MAX917/MAX918  
REFERENCE OUTPUT VOLTAGE vs.  
REFERENCE SOURCE CURRENT**

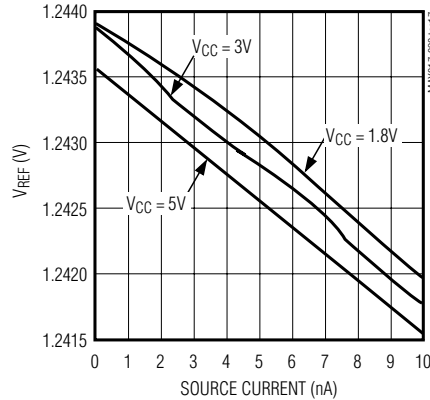

**MAX917/MAX918  
REFERENCE OUTPUT VOLTAGE vs.  
REFERENCE SINK CURRENT**

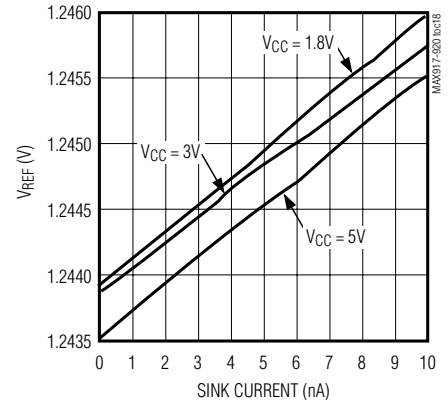

# SOT23, 1.8V, Nanopower, Beyond-the-Rails Comparators With/Without Reference

## Typical Operating Characteristics (continued)

( $V_{CC} = +5V$ ,  $V_{EE} = 0V$ ,  $C_L = 15pF$ ,  $V_{OVERDRIVE} = 100mV$ ,  $T_A = +25^\circ C$ , unless otherwise noted.)

MAX917-MAX920

**PROPAGATION DELAY ( $t_{PD-}$ ) vs. TEMPERATURE**

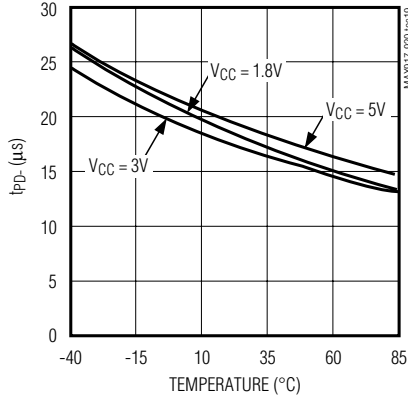

**MAX917/MAX919 PROPAGATION DELAY ( $t_{PD+}$ ) vs. TEMPERATURE**

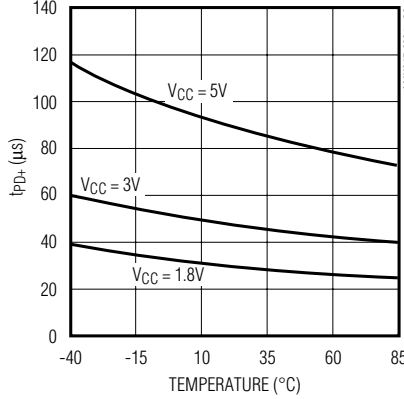

**PROPAGATION DELAY ( $t_{PD-}$ ) vs. CAPACITIVE LOAD**

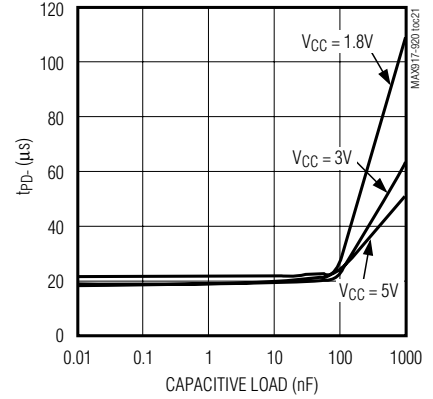

**MAX917/MAX919 PROPAGATION DELAY ( $t_{PD+}$ ) vs. CAPACITIVE LOAD**

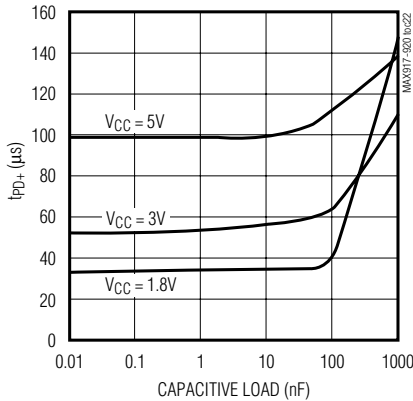

**PROPAGATION DELAY ( $t_{PD-}$ ) vs. INPUT OVERDRIVE**

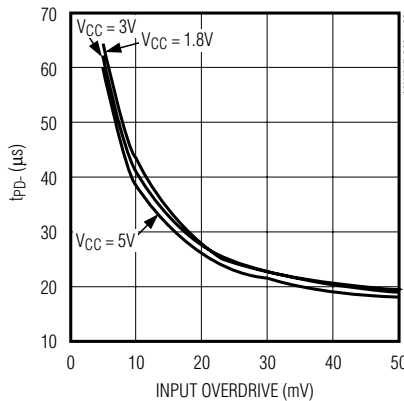

**MAX917/MAX919 PROPAGATION DELAY ( $t_{PD+}$ ) vs. INPUT OVERDRIVE**

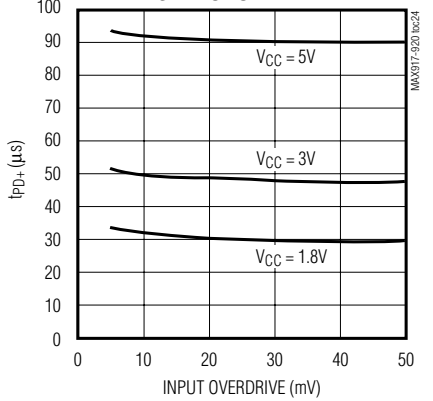

**MAX918/MAX920 PROPAGATION DELAY ( $t_{PD-}$ ) vs. PULLUP RESISTANCE**

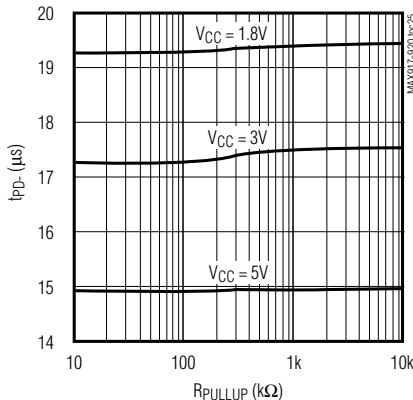

**MAX918/MAX920 PROPAGATION DELAY ( $t_{PD+}$ ) vs. PULLUP RESISTANCE**

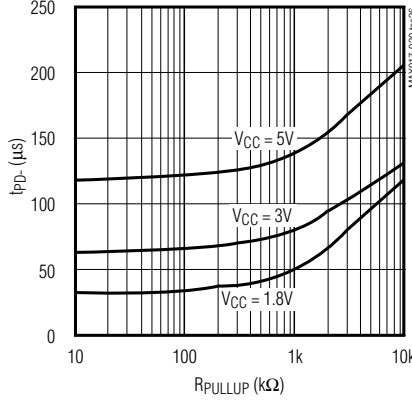

**PROPAGATION DELAY ( $t_{PD-}$ ) ( $V_{CC} = 5V$ )**

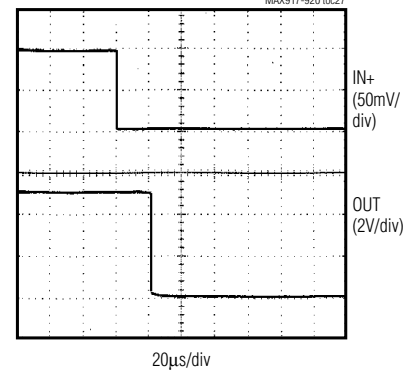

# SOT23, 1.8V, Nanopower, Beyond-the-Rails Comparators With/Without Reference

## Typical Operating Characteristics (continued)

( $V_{CC} = +5V$ ,  $V_{EE} = 0V$ ,  $C_L = 15pF$ ,  $V_{OVERDRIVE} = 100mV$ ,  $T_A = +25^\circ C$ , unless otherwise noted.)

**MAX917/MAX919**  
**PROPAGATION DELAY ( $t_{PD+}$ )**  
**( $V_{CC} = 5V$ )**

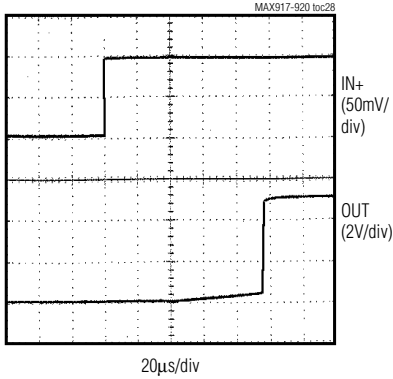

**PROPAGATION DELAY ( $t_{PD-}$ )**  
**( $V_{CC} = 3V$ )**

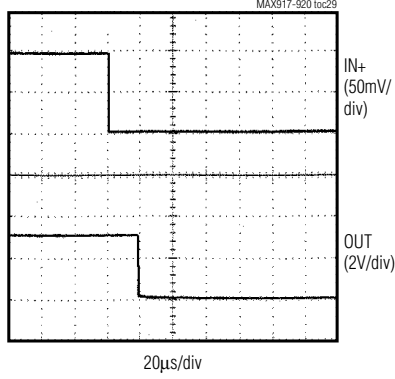

**MAX917/MAX919**  
**PROPAGATION DELAY ( $t_{PD+}$ )**  
**( $V_{CC} = 3V$ )**

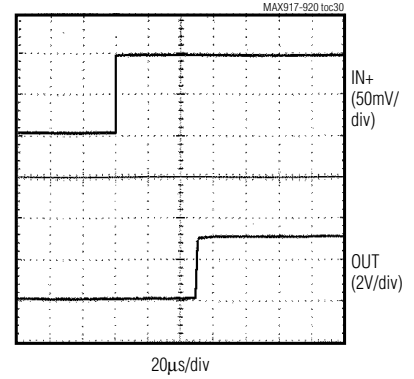

**PROPAGATION DELAY ( $t_{PD-}$ )**  
**( $V_{CC} = 1.8V$ )**

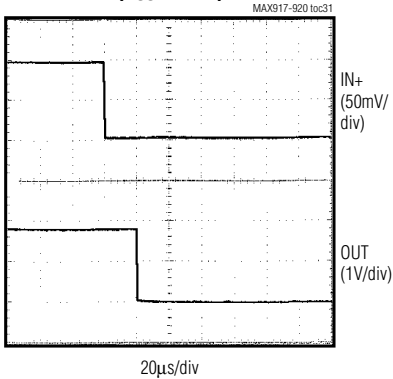

**MAX917/MAX919**  
**PROPAGATION DELAY ( $t_{PD+}$ )**  
**( $V_{CC} = 1.8V$ )**

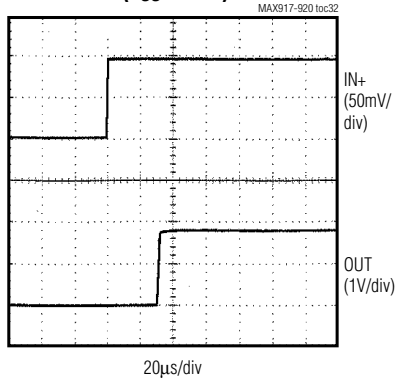

**MAX917/MAX919**  
**10kHz RESPONSE ( $V_{CC} = 1.8V$ )**

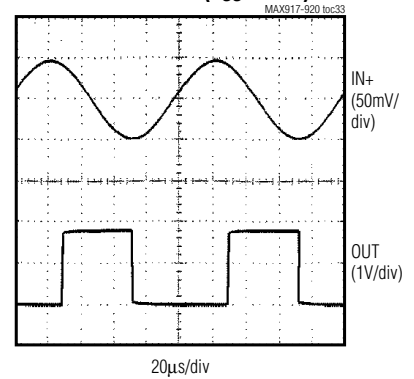

**MAX917/MAX919**  
**1kHz RESPONSE ( $V_{CC} = 5V$ )**

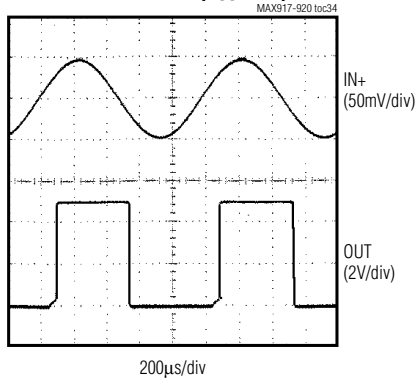

**POWER-UP/DOWN RESPONSE**

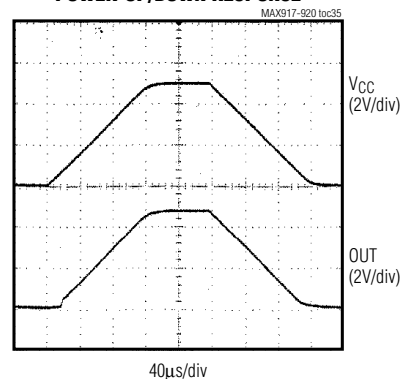



# SOT23, 1.8V, Nanopower, Beyond-the-Rails Comparators With/Without Reference

## Functional Diagrams

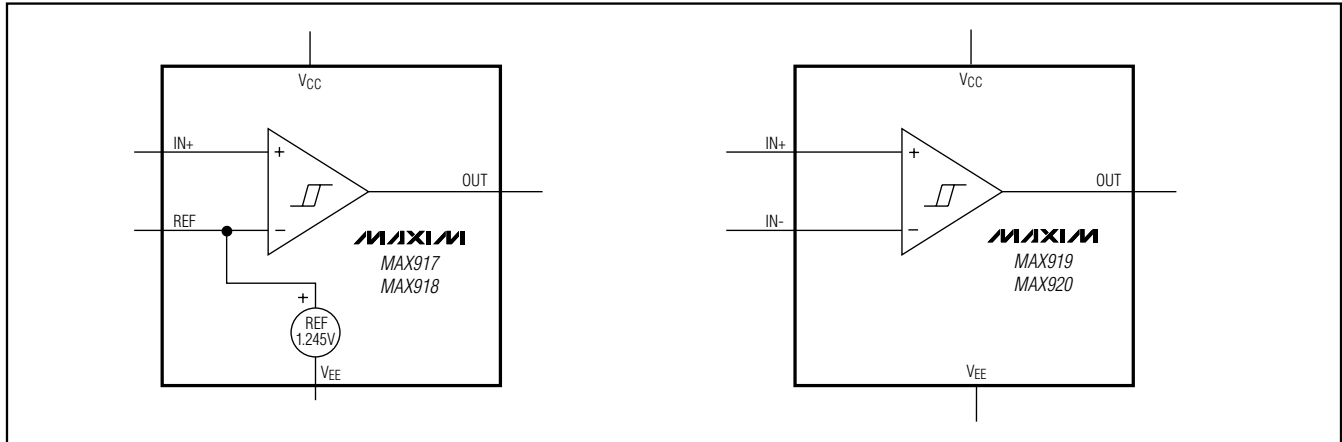

**MAX917-MAX920**

## Pin Description

PIN				NAME	FUNCTION
MAX917/MAX918		MAX919/MAX920			
SOT23-5	SO	SOT23-5	SO		
1	6	1	6	OUT	Comparator Output
2	4	2	4	VEE	Negative Supply Voltage
3	3	3	3	IN+	Comparator Noninverting Input
—	—	4	2	IN-	Comparator Inverting Input
4	2	—	—	REF	1.245V Reference Output and Comparator Inverting Input
5	7	5	7	VCC	Positive Supply Voltage
—	1, 5, 8	—	1, 5, 8	N.C.	No Connection. Not internally connected.

## Detailed Description

The MAX917/MAX918 feature an on-board 1.245V  $\pm 1.5\%$  reference, yet draw an ultra-low supply current of 750nA. The MAX919/MAX920 (without reference) consume just 380nA of supply current. All four devices are guaranteed to operate down to +1.8V. Their common-mode input voltage range extends 200mV beyond-the-rails. Internal hysteresis ensures clean output switching, even with slow-moving input signals. Large internal output drivers allow rail-to-rail output swing with up to  $\pm 8\text{mA}$  loads.

The output stage employs a unique design that minimizes supply-current surges while switching, virtually eliminating the supply glitches typical of many other comparators. The MAX917/MAX919 have a push-pull

output stage that sinks as well as sources current. The MAX918/MAX920 have an open-drain output stage that can be pulled beyond  $V_{CC}$  to an absolute maximum of 6V above  $V_{EE}$ . These open-drain versions are ideal for implementing wire-ORed output logic functions.

### Input Stage Circuitry

The input common-mode voltage range extends from  $V_{EE} - 0.2\text{V}$  to  $V_{CC} + 0.2\text{V}$ . These comparators operate at any differential input voltage within these limits. Input bias current is typically  $\pm 0.15\text{nA}$  if the input voltage is between the supply rails. Comparator inputs are protected from overvoltage by internal ESD protection diodes connected to the supply rails. As the input voltage exceeds the supply rails, these ESD protection diodes become forward biased and begin to conduct.

# SOT23, 1.8V, Nanopower, Beyond-the-Rails Comparators With/Without Reference

## Output Stage Circuitry

The MAX917–MAX920 contain a unique break-before-make output stage capable of rail-to-rail operation with up to  $\pm 8\text{mA}$  loads. Many comparators consume orders of magnitude more current during switching than during steady-state operation. However, with this family of comparators, the supply-current change during an output transition is extremely small. In the *Typical Operating Characteristics*, the Supply Current vs. Output Transition Frequency graphs show the minimal supply-current increase as the output switching frequency approaches 1kHz. This characteristic reduces the need for power-supply filter capacitors to reduce glitches created by comparator switching currents. In battery-powered applications, this characteristic results in a substantial increase in battery life.

## Reference (MAX917/MAX918)

The internal reference in the MAX917/MAX918 has an output voltage of  $+1.245\text{V}$  with respect to  $V_{EE}$ . Its typical temperature coefficient is  $95\text{ppm}/^\circ\text{C}$  over the full  $-40^\circ\text{C}$  to  $+85^\circ\text{C}$  temperature range. The reference is a PNP emitter-follower driven by a  $120\text{nA}$  current source (Figure 1). The output impedance of the voltage reference is typically  $200\text{k}\Omega$ , preventing the reference from driving large loads. The reference can be bypassed with a low-leakage capacitor. The reference is stable for any capacitive load. For applications requiring a lower output impedance, buffer the reference with a low-input-leakage op amp, such as the MAX406.

## Applications Information

### Low-Voltage, Low-Power Operation

The MAX917–MAX920 are ideally suited for use with most battery-powered systems. Table 1 lists a variety of battery types, capacities, and approximate operating times for the MAX917–MAX920, assuming nominal conditions.

**Table 1. Battery Applications Using MAX917–MAX920**

BATTERY TYPE	RECHARGEABLE	$V_{\text{FRESH}}$ (V)	$V_{\text{END-OF-LIFE}}$ (V)	CAPACITY, AA SIZE (mA-h)	MAX917/MAX918 OPERATING TIME (hr)	MAX919/MAX920 OPERATING TIME (hr)
Alkaline (2 Cells)	No	3.0	1.8	2000	$2.5 \times 10^6$	$5 \times 10^6$
Nickel-Cadmium (2 Cells)	Yes	2.4	1.8	750	937,500	$1.875 \times 10^6$
Lithium-Ion (1 Cell)	Yes	3.5	2.7	1000	$1.25 \times 10^6$	$2.5 \times 10^6$
Nickel-Metal-Hydride (2 Cells)	Yes	2.4	1.8	1000	$1.25 \times 10^6$	$2.5 \times 10^6$

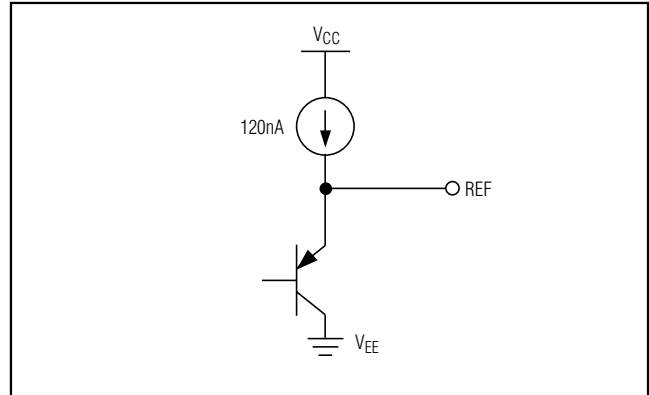

Figure 1. MAX917/MAX918 Voltage Reference Output Equivalent Circuit

## Internal Hysteresis

Many comparators oscillate in the linear region of operation because of noise or undesired parasitic feedback. This tends to occur when the voltage on one input is equal or very close to the voltage on the other input. The MAX917–MAX920 have internal hysteresis to counter parasitic effects and noise.

The hysteresis in a comparator creates two trip points: one for the rising input voltage ( $V_{\text{THR}}$ ) and one for the falling input voltage ( $V_{\text{THF}}$ ) (Figure 2). The difference between the trip points is the hysteresis ( $V_{\text{HB}}$ ). When the comparator's input voltages are equal, the hysteresis effectively causes one comparator input to move quickly past the other, thus taking the input out of the region where oscillation occurs. Figure 2 illustrates the case in which  $\text{IN-}$  has a fixed voltage applied, and  $\text{IN+}$  is varied. If the inputs were reversed, the figure would be the same, except with an inverted output.

# SOT23, 1.8V, Nanopower, Beyond-the-Rails Comparators With/Without Reference

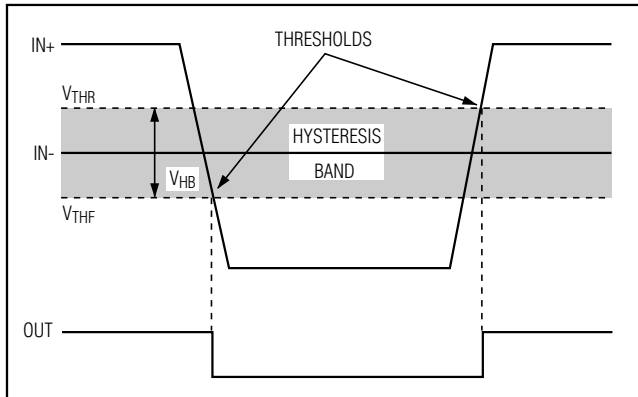

Figure 2. Threshold Hysteresis Band

## Additional Hysteresis (MAX917/MAX919)

The MAX917/MAX919 have a 4mV internal hysteresis band ( $V_{HB}$ ). Additional hysteresis can be generated with three resistors using positive feedback (Figure 3). Unfortunately, this method also slows hysteresis response time. Use the following procedure to calculate resistor values.

1) Select  $R_3$ . Leakage current at  $I_{IN}$  is under 2nA, so the current through  $R_3$  should be at least 0.2 $\mu$ A to minimize errors caused by leakage current. The current through  $R_3$  at the trip point is  $(V_{REF} - V_{OUT})/R_3$ . Considering the two possible output states in solving for  $R_3$  yields two formulas:  $R_3 = V_{REF}/I_{R3}$  or  $R_3 = (V_{CC} - V_{REF})/I_{R3}$ . Use the smaller of the two resulting resistor values. For example, when using the MAX917 ( $V_{REF} = 1.245V$ ) and  $V_{CC} = 5V$ , and if we choose  $I_{R3} = 1\mu A$ , then the two resistor values are 1.2M $\Omega$  and 3.8M $\Omega$ . Choose a 1.2M $\Omega$  standard value for  $R_3$ .

2) Choose the hysteresis band required ( $V_{HB}$ ). For this example, choose 50mV.

3) Calculate  $R_1$  according to the following equation:

$$R_1 = R_3 (V_{HB} / V_{CC})$$

For this example, insert the values

$$R_1 = 1.2M\Omega (50mV/5V) = 12k\Omega$$

4) Choose the trip point for  $V_{IN}$  rising ( $V_{THR}$ ) such that  $V_{THR} > V_{REF} \cdot (R_1 + R_3)/R_3$  ( $V_{THF}$  is the trip point for  $V_{IN}$  falling). This is the threshold voltage at which the comparator switches its output from low to high as  $V_{IN}$  rises above the trip point. For this example, choose 3V.

5) Calculate  $R_2$  as follows:

$$R_2 = 1/[V_{THR}/(V_{REF} \cdot R_1) - (1 / R_1) - (1 / R_3)]$$

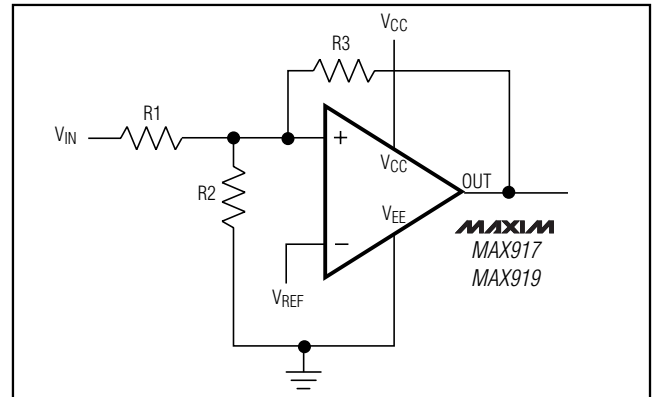

Figure 3. MAX917/MAX919 Additional Hysteresis

$$R_2 = 1/[3.0V/(1.2V \cdot 12k\Omega) - (1 / 12k\Omega) - (1/1.2M\Omega)] = 8.05k\Omega$$

For this example, choose an 8.2k $\Omega$  standard value.

6) Verify the trip voltages and hysteresis as follows:

$$V_{IN} \text{ rising: } V_{THR} = V_{REF} \cdot R_1 [(1 / R_1) + (1 / R_2) + (1 / R_3)]$$

$$V_{IN} \text{ falling: } V_{THF} = V_{THR} - (R_1 \cdot V_{CC} / R_3)$$

$$\text{Hysteresis} = V_{THR} - V_{THF}$$

## Additional Hysteresis (MAX918/MAX920)

The MAX918/MAX920 have a 4mV internal hysteresis band. They have open-drain outputs and require an external pullup resistor (Figure 4). Additional hysteresis can be generated using positive feedback, but the formulas differ slightly from those of the MAX917/MAX919. Use the following procedure to calculate resistor values.

1) Select  $R_3$  according to the formulas  $R_3 = V_{REF} / 1\mu A$  or  $R_3 = (V_{CC} - V_{REF})/1\mu A - R_4$ . Use the smaller of the two resulting resistor values.

2) Choose the hysteresis band required ( $V_{HB}$ ).

3) Calculate  $R_1$  according to the following equation:

$$R_1 = (R_3 + R_4) (V_{HB}/V_{CC})$$

4) Choose the trip point for  $V_{IN}$  rising ( $V_{THR}$ ) ( $V_{THF}$  is the trip point for  $V_{IN}$  falling). This is the threshold voltage at which the comparator switches its output from low to high as  $V_{IN}$  rises above the trip point.

5) Calculate  $R_2$  as follows:

$$R_2 = 1/[V_{THR}/(V_{REF} \cdot R_1) - \left(\frac{1}{R_1}\right) - \frac{1}{R_3}]$$

# SOT23, 1.8V, Nanopower, Beyond-the-Rails Comparators With/Without Reference

6) Verify the trip voltages and hysteresis as follows:

$$V_{IN \text{ rising}}: V_{THR} = V_{REF} \times R1 \left( \frac{1}{R1} + \frac{1}{R2} + \frac{1}{R3} \right)$$

$$V_{IN \text{ falling}}: V_{THF} =$$

$$V_{REF} \times R1 \left( \frac{1}{R1} + \frac{1}{R2} + \frac{1}{R3+R4} \right) - \frac{R1}{R3+R4} \times V_{CC}$$

$$\text{Hysteresis} = V_{THR} - V_{THF}$$

### Board Layout and Bypassing

Power-supply bypass capacitors are not typically needed, but use 100nF bypass capacitors close to the device's supply pins when supply impedance is high, supply leads are long, or excessive noise is expected on the supply lines. Minimize signal trace lengths to reduce stray capacitance. A ground plane and surface-mount components are recommended.

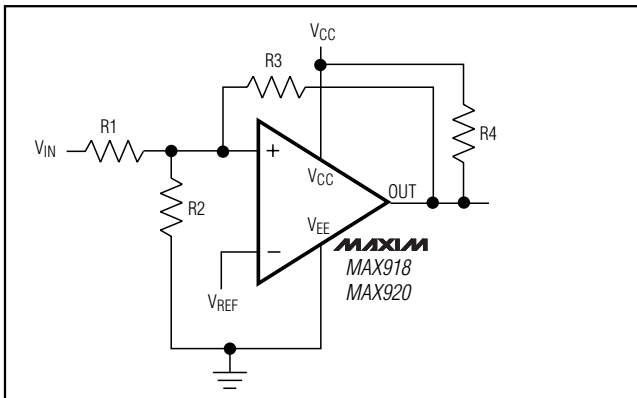
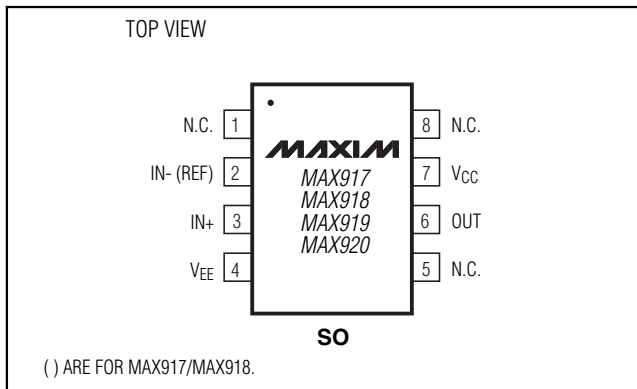

Figure 4. MAX918/MAX920 Additional Hysteresis

### Pin Configurations (continued)



### Zero-Crossing Detector

Figure 5 shows a zero-crossing detector application. The MAX919's inverting input is connected to ground, and its noninverting input is connected to a 100mVp-p signal source. As the signal at the noninverting input crosses 0V, the comparator's output changes state.

### Logic-Level Translator

The *Typical Application Circuit* shows an application that converts 5V logic to 3V logic levels. The MAX920 is powered by the +5V supply voltage, and the pullup resistor for the MAX920's open-drain output is connected to the +3V supply voltage. This configuration allows the full 5V logic swing without creating overvoltage on the 3V logic inputs. For 3V to 5V logic-level translations, simply connect the +3V supply voltage to VCC and the +5V supply voltage to the pullup resistor.

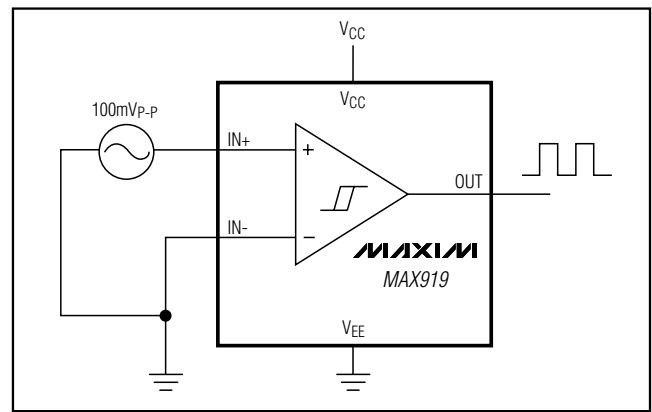
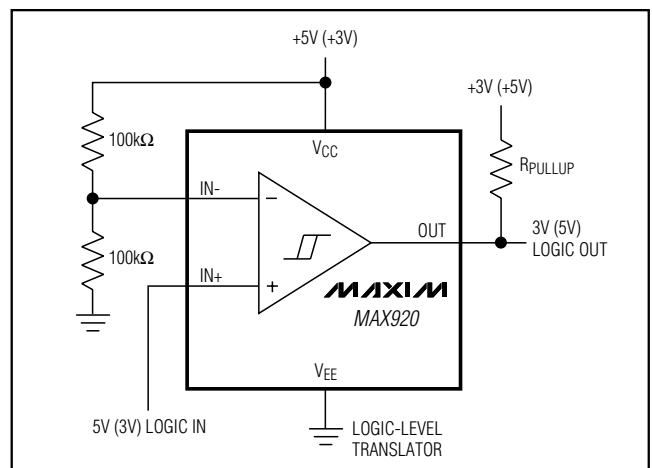

Figure 5. Zero-Crossing Detector

### Typical Application Circuit



# SOT23, 1.8V, Nanopower, Beyond-the-Rails Comparators With/Without Reference

## Package Information

For the latest package outline information and land patterns, go to [www.maxim-ic.com/packages](http://www.maxim-ic.com/packages). Note that a "+", "#", or "-" in the package code indicates RoHS status only. Package drawings may show a different suffix character, but the drawing pertains to the package regardless of RoHS status.

PACKAGE TYPE	PACKAGE CODE	OUTLINE NO.	LAND PATTERN NO.
8 SO	S8+2	<a href="#">21-0041</a>	<a href="#">90-0096</a>
SOT23	U5+1	<a href="#">21-0057</a>	<a href="#">90-0174</a>

MAX917-MAX920

SOT-23 5L .EPS

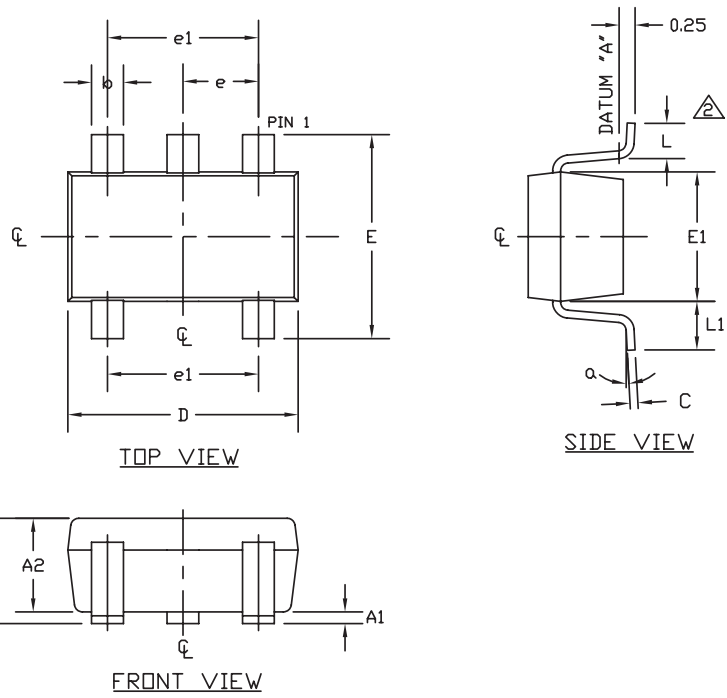

SYMBOL	MIN	NOM	MAX
A	0.90	1.25	1.45
A1	0.00	0.05	0.15
A2	0.90	1.10	1.30
b	0.35	0.40	0.50
C	0.08	0.15	0.20
D	2.80	2.90	3.00
E	2.60	2.80	3.00
E1	1.50	1.625	1.75
L	0.35	0.45	0.60
L1	0.60 REF		
e	0.95 BSC.		
e1	1.90 BSC.		
a	0°	2.5°	8°
PKG CODES: U5-1, U5-2			

- NOTES:
1. ALL DIMENSIONS ARE IN MILLIMETERS.
  2. FOOT LENGTH MEASURED AT INTERCEPT POINT BETWEEN DATUM A & LEAD SURFACE.
  3. PACKAGE OUTLINE EXCLUSIVE OF MOLD FLASH & METAL BURR. MOLD FLASH, PROTRUSION OR METAL BURR SHOULD NOT EXCEED 0.25 MM.
  4. PACKAGE OUTLINE INCLUSIVE OF SOLDER PLATING.
  5. MEETS JEDEC MQ178, VARIATION AA.
  6. LEADS TO BE COPLANAR WITHIN 0.10 mm.
  7. SOLDER THICKNESS MEASURED AT FLAT SECTION OF LEAD BETWEEN 0.08mm AND 0.15mm FROM LEAD TIP.

<small>PROPRIETARY INFORMATION</small>			
<small>TITLE:</small> PACKAGE OUTLINE, SOT-23, 5L			
<small>APPROVAL:</small>	<small>DOCUMENT CONTROL NO.</small> 21-0057	<small>REV.</small> F	<small>1/1</small>

# SOT23, 1.8V, Nanopower, Beyond-the-Rails Comparators With/Without Reference

## Package Information (continued)

For the latest package outline information and land patterns, go to [www.maxim-ic.com/packages](http://www.maxim-ic.com/packages). Note that a "+", "#", or "-" in the package code indicates RoHS status only. Package drawings may show a different suffix character, but the drawing pertains to the package regardless of RoHS status.

TOP VIEW

END VIEW

COMMON DIMENSIONS				
SYMBOL	INCHES		MM	
	MIN.	MAX.	MIN.	MAX.
A	.053	.069	1.35	1.75
A1	.004	.010	0.10	0.25
b	.014	.019	0.35	0.49
c	.007	.010	0.19	0.25
E	.150	.157	3.80	4.00
e	.050 BSC		1.27 BSC	
H	.220	.244	5.80	6.20
L	.016	.050	0.40	1.27
∅	0°	8°	0°	8°

SIDE VIEW

**NOTES:**

1. ALL DIMENSIONS ARE IN MILLIMETERS UNLESS OTHERWISE SPECIFIED.
2. MATERIAL MUST COMPLY WITH BANNED AND RESTRICTED SUBSTANCES SPEC # 10-0131.
3. DIMENSIONS D AND E DO NOT INCLUDE MOLD PROTRUSION. ALLOWABLE MOLD PROTRUSION IS 0.15 MM (.006") PER SIDE.
4. LEADS TO BE COPLANAR WITHIN 0.10mm (.004").
5. MEETS JEDEC MS012
6. ALL DIMENSIONS APPLY TO BOTH LEADED (-) AND PbfREE (+) PKG. CODES.

-DRAWING NOT TO SCALE-

VARIATION A				
SYMBOL	INCHES		MM	
	MIN.	MAX.	MIN.	MAX.
D	.189	.197	4.80	5.00
N	8			
MS012	AA			
PKG. CODE	S8-2, S8-4, S8-5, S8-6F, S8-7F, S8-8F, S8-10F, S8-11F, S8-16F			

VARIATION B				
SYMBOL	INCHES		MM	
	MIN.	MAX.	MIN.	MAX.
D	.337	.344	8.55	8.75
N	14			
MS012	AB			
PKG. CODE	S14-1, S14-4, S14-5, S14-6, S14M-4, S14M-5, S14M-6, S14M-7			

VARIATION C				
SYMBOL	INCHES		MM	
	MIN.	MAX.	MIN.	MAX.
D	.386	.394	9.80	10.00
N	16			
MS012	AC			
PKG. CODE	S16-1, S16-3, S16-5, S16-6, S16-8, S16-7F, S16-9F, S16-10F, S16M-3, S16M-6			

TITLE:  
PACKAGE OUTLINE,  
BL, 14L, 16L SOIC .150 INCH

APPROVAL	DOCUMENT CONTROL NO. 21-0041	REV. C	1/1
----------	---------------------------------	--------	-----

# SOT23, 1.8V, Nanopower, Beyond-the-Rails Comparators With/Without Reference

## Revision History

REVISION NUMBER	REVISION DATE	DESCRIPTION	PAGES CHANGED
2	10/10	Added lead-free and automotive qualified parts	1, 2

MAX917-MAX920

Maxim cannot assume responsibility for use of any circuitry other than circuitry entirely embodied in a Maxim product. No circuit patent licenses are implied. Maxim reserves the right to change the circuitry and specifications without notice at any time.

15 \_\_\_\_\_ **Maxim Integrated Products, 120 San Gabriel Drive, Sunnyvale, CA 94086 408-737-7600**