

7 W Pulsed High Power Amplifier 2.7 - 3.0 GHz, 6 mm PQFN 28-LD

Rev. V3

Features

- 7 W Pulsed Output Power (Saturated)
- 23 dB Gain
- +10 V Bias Operation
- 50 Ω Impedance, Balanced Design
- Lead-Free 6 mm 28-lead PQFN Package
- Halogen-Free “Green” Mold Compound
- RoHS* Compliant and 260°C Reflow Compatible

Description

The MAAP-011022 is a 2.7 to 3.0 GHz high power balanced amplifier, which is designed for S-Band aviation and weather radar applications. This device puts out 7 W pulsed and is designed to operate at an 8% duty cycle.

The MAAP-011022 is packaged in a lead-free 6 mm 28-lead plastic package for high volume manufacturing. This IC utilizes one of MACOM’s advanced 0.5 μm processes, which has been optimized so amplifiers, passives, and control components can be combined on a single IC.

This MAAP-011022 is specifically targeted for avionics and weather radar.

Ordering Information^{1,2}

Part Number	Package
MAAP-011022-TR0500	500 piece reel
MAAP-011022-001SMB	Sample Test Board

1. Reference Application Note M513 for reel size information.
2. Sample board includes 5 loose parts.

*Restrictions on Hazardous Substances,
European Union Directive 2011/65/EU.

Functional Block Diagram

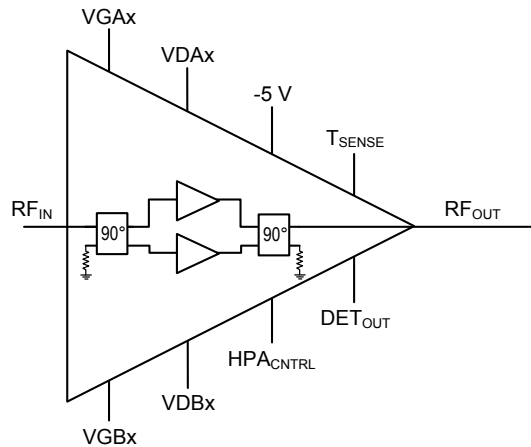

Pin Configuration^{3,4,5,6}

Pin No.	Function	Pin No.	Function
1	VD2A	15	VC _{OUT}
2	No Connection	16	VG1B
3	VD1A	17	VG2B
4	No Connection	18	No Connection
5	VG2A	19	VD1B
6	VG1A	20	No Connection
7	No Connection	21	VD2B
8	No Connection	22	No Connection
9	RF _{IN}	23	RF _{OUT}
10	No Connection	24	No Connection
11	No Connection	25	No Connection
12	No Connection	26	No Connection
13	HPA _{CNTRL}	27	DET _{OUT}
14	-5 V	28	T _{SENSE}
		29 ⁷	Ground Pad

3. See the evaluation board schematic for the recommended external components.
4. VD_{Ax} and VD_{Bx} are connected to the +10 V bias.
5. The gates are controlled internally from the bias circuit shown on the evaluation board schematic but need to be bypassed as shown. VG_{Ax} must be connected to VGB_x.
6. HPA_{CNTRL} is tied to +5 V for drain switching. For gate switching the PA is turned off when HPA_{CNTRL} is at 0 V.
7. The exposed pad centered on the package bottom must be connected to RF, DC and thermal ground.

7 W Pulsed High Power Amplifier 2.7 - 3.0 GHz, 6 mm PQFN 28-LD

Rev. V3

Electrical Specifications: Freq. = 2.7 - 3.0 GHz, $T_A = 25^\circ\text{C}$, $V_{DAX} = V_{DBX} = +10\text{ V}$, $I_{DQ} = \sim 2.0\text{ A}$, $Z_0 = 50\ \Omega$, 80 μs Pulse, 8% Duty Cycle

Parameter	Units	Min.	Typ.	Max.
Small-Signal Gain	dB	21.0	23.5	25
Input / Output Return Loss	dB	-	20	-
P1dB	dBm		37.5	-
P_{SAT} ($P_{IN} = +18\text{ dBm}$)	dBm	37.0	38.3	-
PAE	%	-	28.0	-
Power Detector Voltage ⁸ @ P3dB	mV	-	2200	-
Temperature Sensor Voltage ⁹ @ 25°C	V	-3.50	-3.24	-3.00
-5 V Current	mA	-	9.0	20.0
Drain Current	A	-	2.5	3.4

8. Under RF drive.

9. Slope $-1.69\text{ mV}/^\circ\text{C}$

Absolute Maximum Ratings^{10,11,12,13}

Parameter	Absolute Maximum
RF Input Power	+25 dBm
Drain Voltage	12 V
Gate Voltage (V_{GAX} , V_{GBX})	-3 V to 0 V ¹³
Negative Voltage	-6 V \leq -5 V Bias \leq 0.5 V
Duty Cycle	10 %
Operating Temperature	-40°C to $+85^\circ\text{C}$
Junction Temperature ¹⁴	160°C
Storage Temperature	-65°C to $+125^\circ\text{C}$

10. Exceeding any one or combination of these limits may cause permanent damage to this device.

11. MACOM does not recommend sustained operation near these survivability limits.

12. Operating at nominal conditions with $T_J \leq 160^\circ\text{C}$ will ensure $MTTF > 1 \times 10^6$ hours.

13. V_{GAX} , V_{GBX} can go to +0.3 V if no drain voltage is applied.

14. Junction Temperature (T_J) = $T_C + \Theta_{JC} * ((V * I) - (P_{OUT} - P_{IN}))$

Typical thermal resistance:

80 μs pulse, 8% duty cycle, $\Theta_{JC} = 2.0^\circ\text{C}/\text{W}$

a) For $T_C = +25^\circ\text{C}$,

$T_J = 62^\circ\text{C}$ @ 10 V, 2.5 A, $P_{OUT} = 6.6\text{ W}$, $P_{IN} = 0.07\text{ W}$

b) For $T_C = +85^\circ\text{C}$,

$T_J = 143^\circ\text{C}$ @ 10 V, 3.4 A, $P_{OUT} = 5.0\text{ W}$, $P_{IN} = 0.07\text{ W}$

Handling Procedures

Please observe the following precautions to avoid damage:

Static Sensitivity

Gallium Arsenide and Silicon Integrated Circuits are sensitive to electrostatic discharge (ESD) and can be damaged by static electricity. Proper ESD control techniques should be used when handling these devices.

7 W Pulsed High Power Amplifier 2.7 - 3.0 GHz, 6 mm PQFN 28-LD

Rev. V3

Evaluation Board Schematic^{15,16}

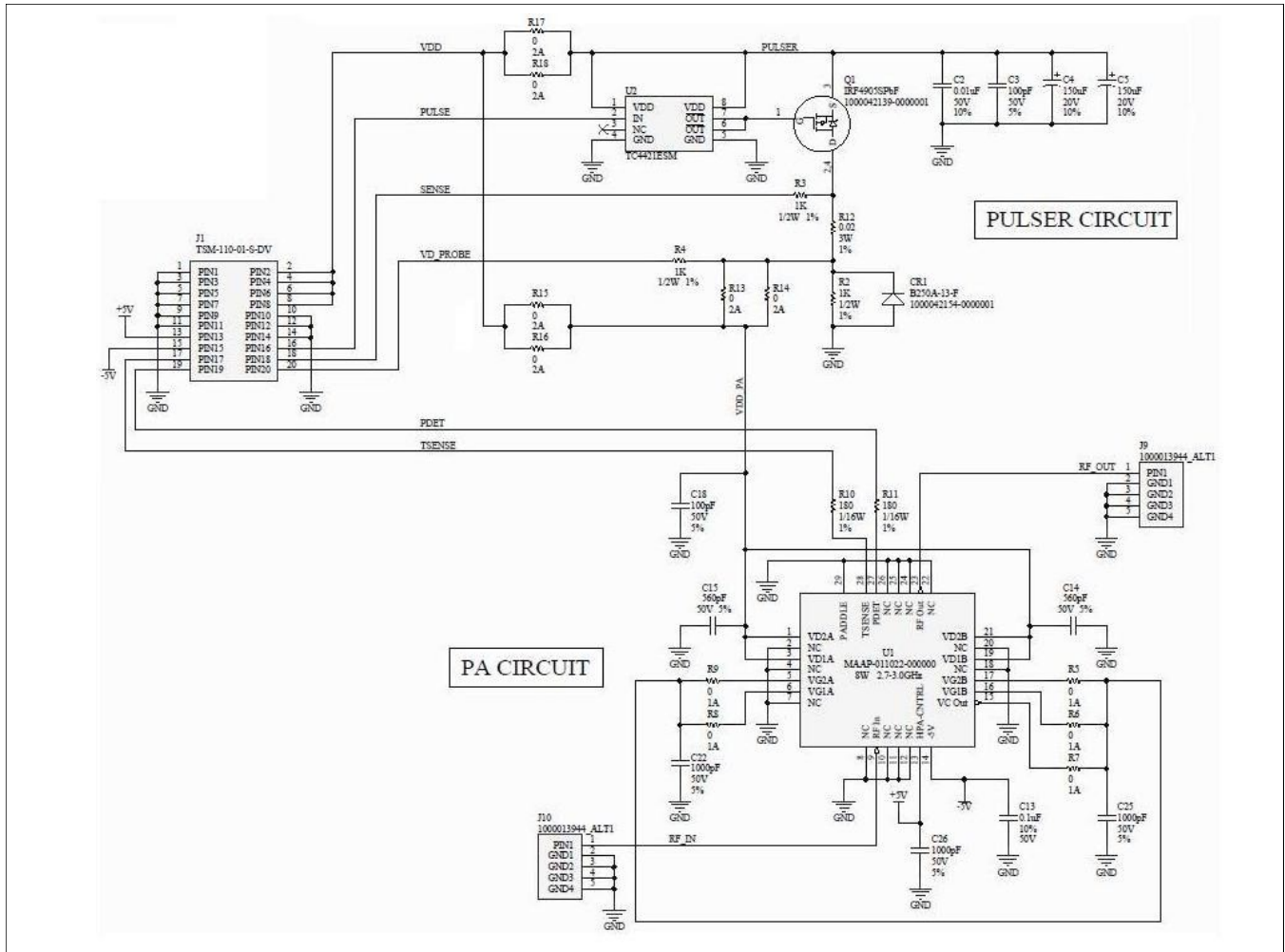

15. The standard build configuration is to omit resistors R15 & R16. This configuration activates the on-board +10 V pulser circuit.
 16. In order to bypass on-board +10 V pulser circuit, remove R13, R14, R17 & R18, and add R15 & R16.

Parts List

Part	Value	Case Style
CR1	50 V Diode	-
C2	.01 μ F	0603
C3, C18	100 pF	0603
C4, C5	150 μ F	-
C13	0.1 μ f	0402
C14, C15	560 pF	0402
C22, C25	1000 pF	0402
R1, R5 - R9	0 Ω	0402
R2 - R4	1 k Ω	1210
R10, R11	180 Ω	0402
R12	0.02 Ω	4527
R13 - R18	0 Ω	1206

Parts List

Part	Value	Case Style
J1	10 Row	Header
J7 - J10	Connector	SMA
Q1	IRF4905SPbF	T0-220AB
U1	8 W HPA	6mm PQFN-28LD
U2	TC4421ESM	8-SOIC

7 W Pulsed High Power Amplifier 2.7 - 3.0 GHz, 6 mm PQFN 28-LD

Rev. V3

Typical Performance Curves: $V_{DAx}=V_{DBx}=10\text{ V}$, $I_{DQ}=2.0\text{ A}$ (80 μs Pulse, 8% Duty Cycle)

Gain vs. Frequency

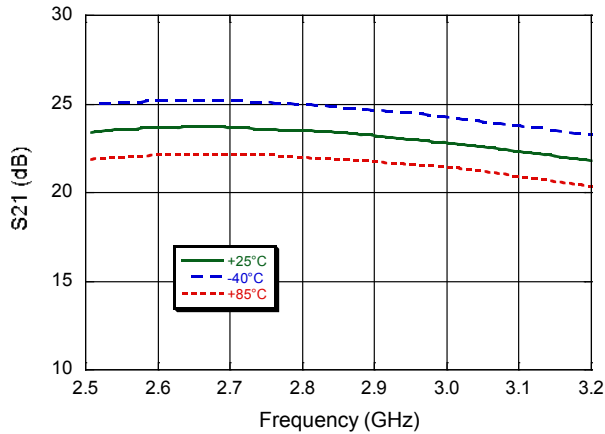

Input Return Loss vs. Frequency

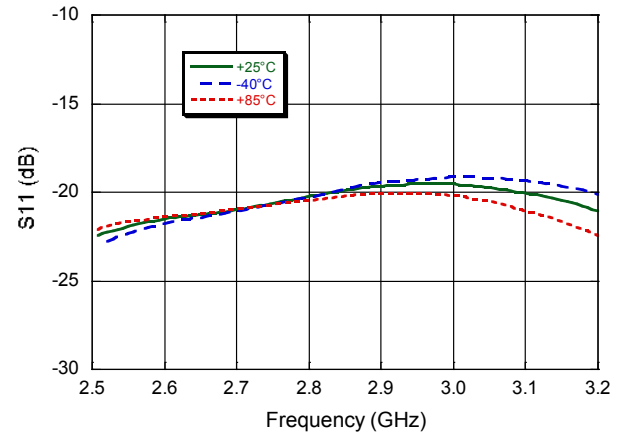

Output Return Loss vs. Frequency

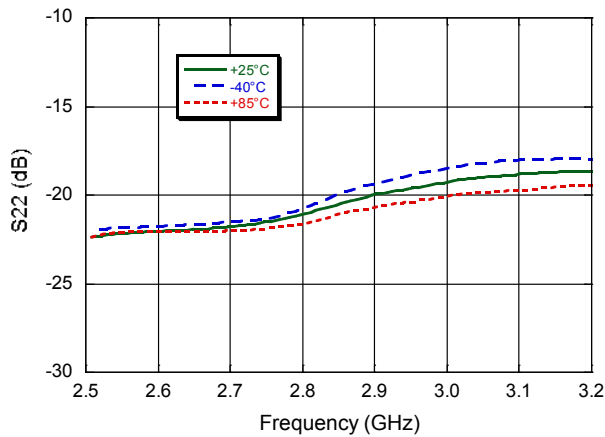

Reverse Isolation vs. Frequency

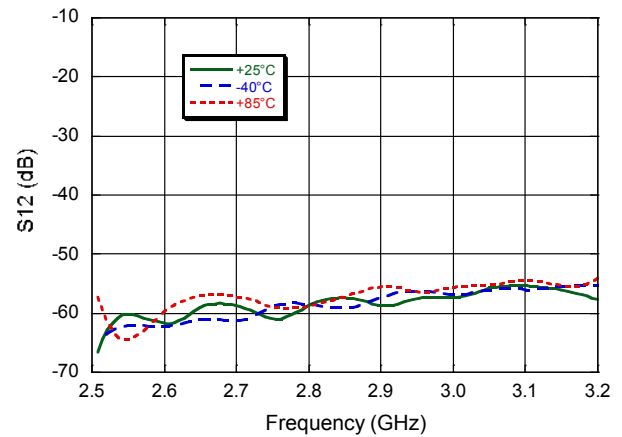

Gain vs. Output Power

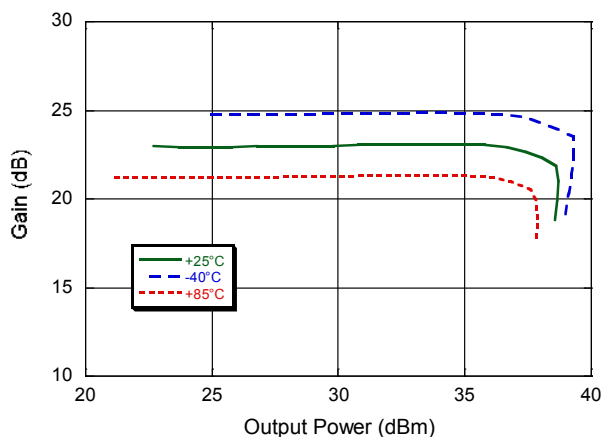

Drain Current vs. Output Power
(80 μs Pulse, 8% Duty Cycle)

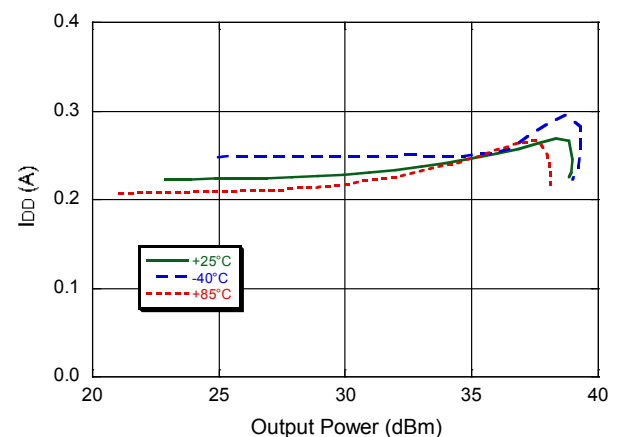

7 W Pulsed High Power Amplifier 2.7 - 3.0 GHz, 6 mm PQFN 28-LD

Rev. V3

Typical Performance Curves: $V_{DAx}=V_{DBx}=10\text{ V}$, $I_{DQ}=2.0\text{ A}$ (80 μs Pulse, 8% Duty Cycle)

P1dB vs. Frequency

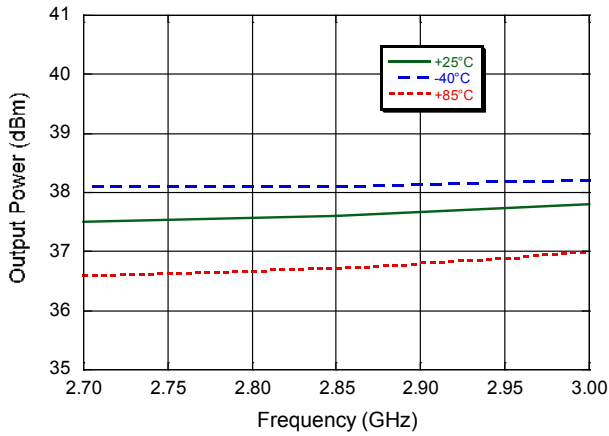

P3dB vs. Frequency

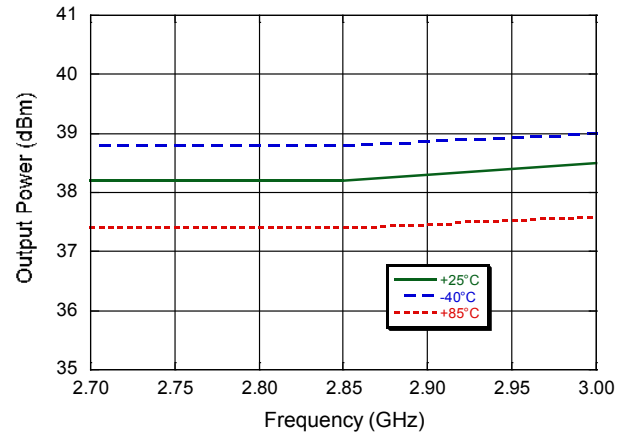

PAE vs. Frequency

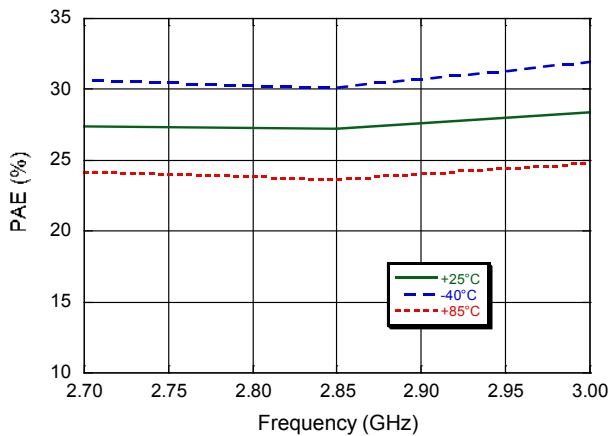

Power Detector Voltage vs. Output Power

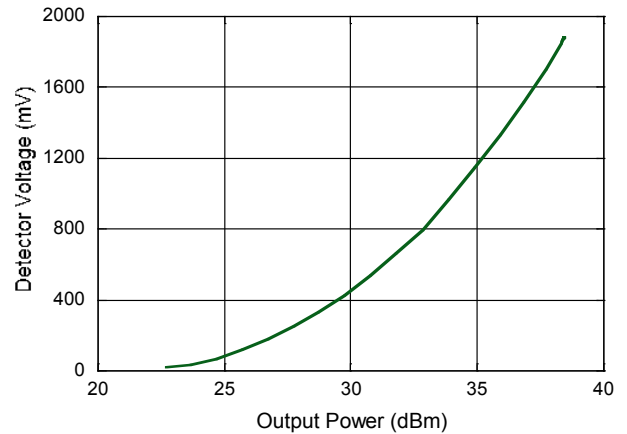

Temperature Sensor Voltage vs. Temperature

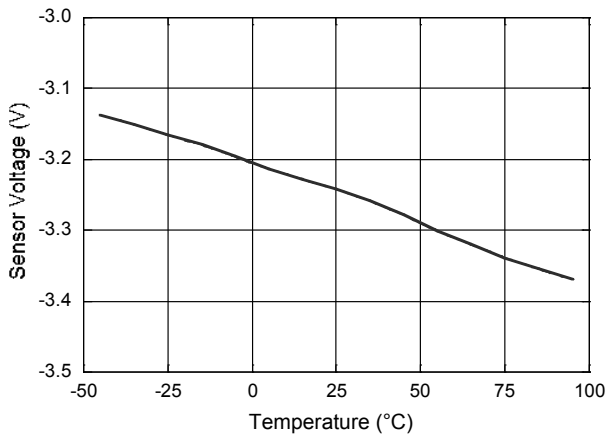

7 W Pulsed High Power Amplifier 2.7 - 3.0 GHz, 6 mm PQFN 28-LD

Rev. V3

Typical Performance Curves: $V_{DAx}=V_{DBx}=10\text{ V}$, $I_{DQ}=2.0\text{ A}$ (80 μs Pulse, 8% Duty Cycle)

Load Ruggedness 2:1 vs. Input Power

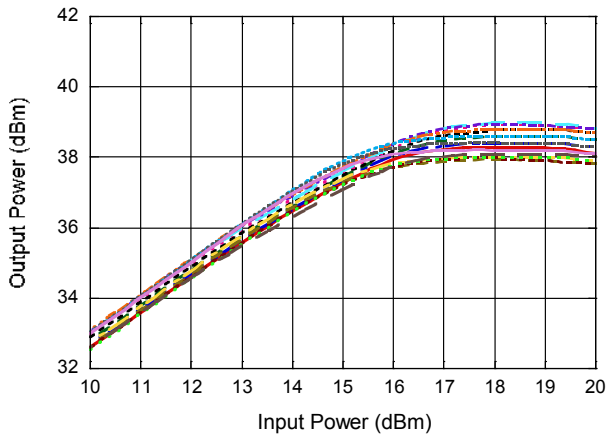

Load Ruggedness 3:1 vs. Input Power

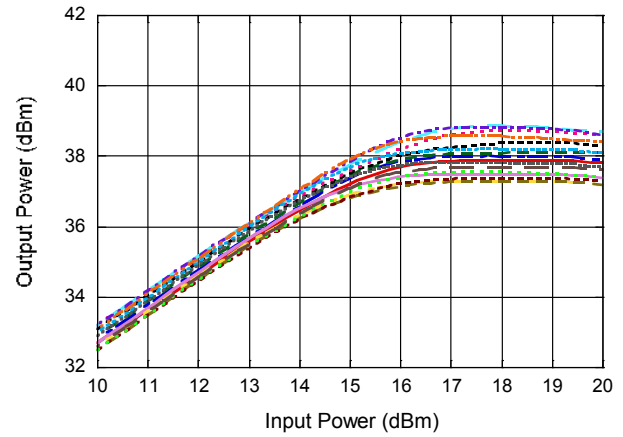

Load Ruggedness 6:1 vs. Input Power

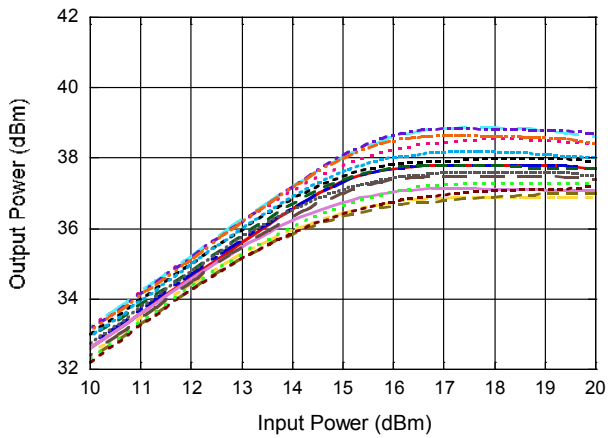

Load Ruggedness 9:1 vs. Input Power

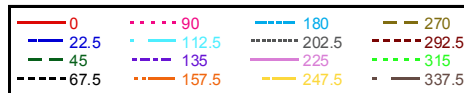
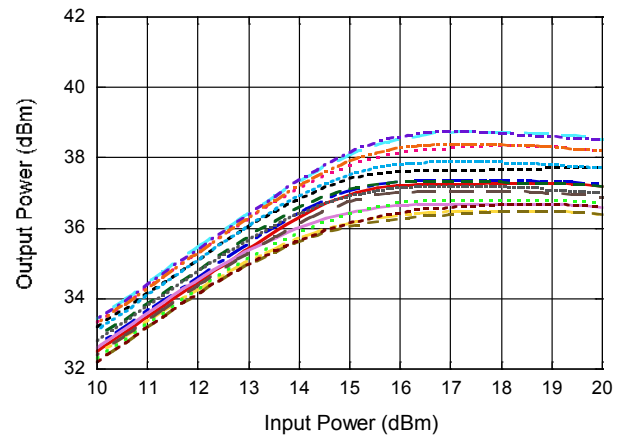

7 W Pulsed High Power Amplifier 2.7 - 3.0 GHz, 6 mm PQFN 28-LD

Rev. V3

Typical Performance Curves: $V_{DAx}=V_{DBx}=10\text{ V}$, $I_{DQ}=2.0\text{ A}$ (80 μs Pulse, 8% Duty Cycle)

2nd Harmonic @ P1dB vs. Frequency

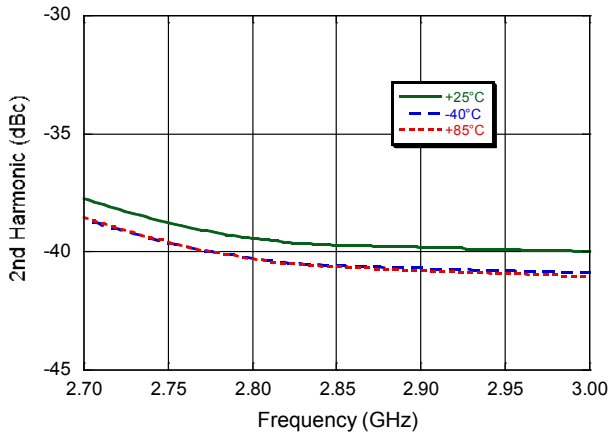

3rd Harmonic @ P1dB vs. Frequency

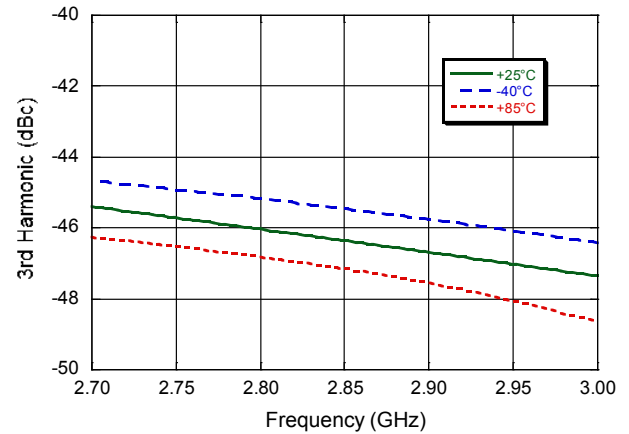

2nd Harmonic @ P3dB vs. Frequency

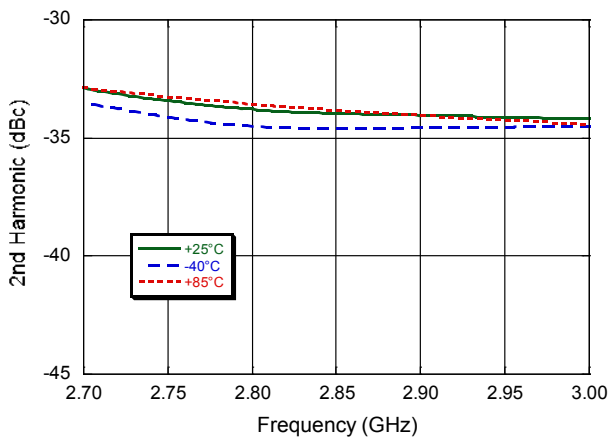

3rd Harmonic @ P3dB vs. Frequency

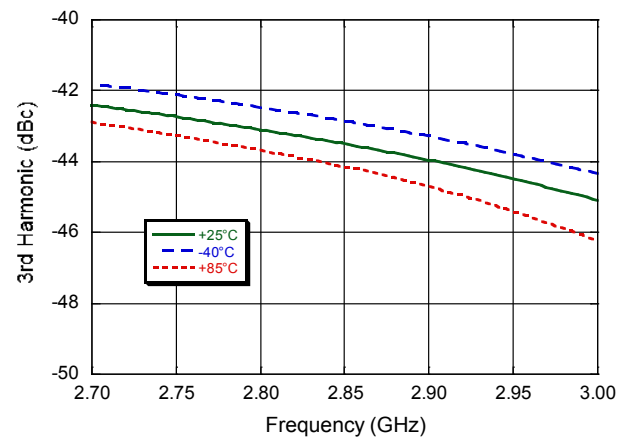

2nd Harmonic @ -10 dBm vs. Frequency

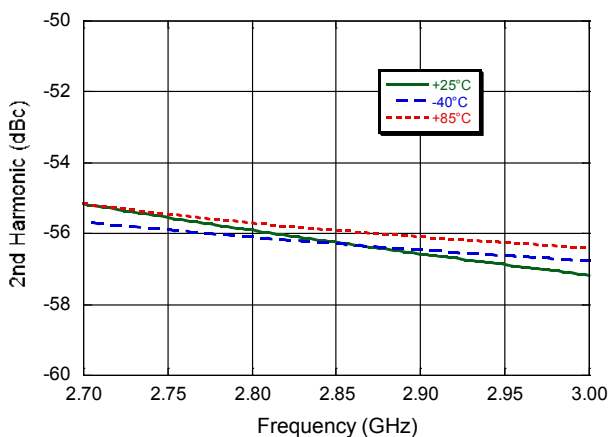

Lead-Free 6 mm 28-Lead PQFN†

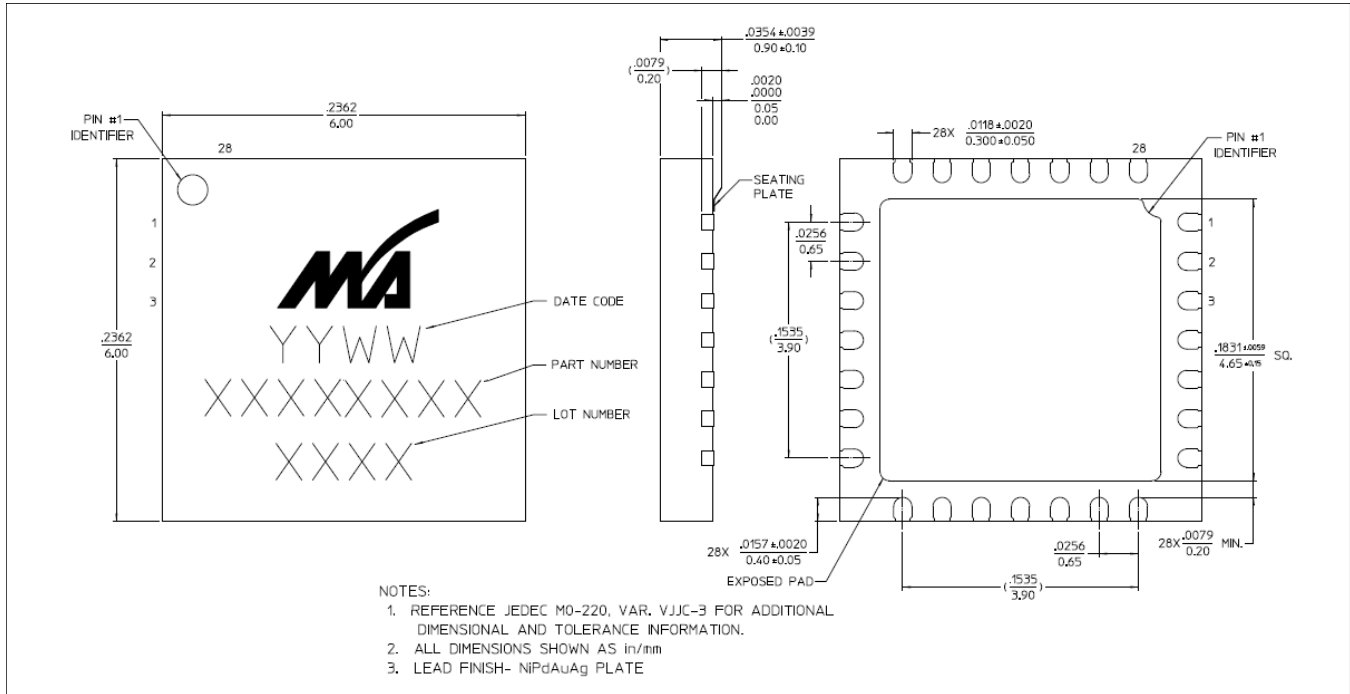

† Reference Application Note S2083 for lead-free solder reflow recommendations.
 Meets JEDEC moisture sensitivity level 1 requirements.
 Plating is NiPdAuAg.

M/A-COM Technology Solutions Inc. All rights reserved.

Information in this document is provided in connection with M/A-COM Technology Solutions Inc ("MACOM") products. These materials are provided by MACOM as a service to its customers and may be used for informational purposes only. Except as provided in MACOM's Terms and Conditions of Sale for such products or in any separate agreement related to this document, MACOM assumes no liability whatsoever. MACOM assumes no responsibility for errors or omissions in these materials. MACOM may make changes to specifications and product descriptions at any time, without notice. MACOM makes no commitment to update the information and shall have no responsibility whatsoever for conflicts or incompatibilities arising from future changes to its specifications and product descriptions. No license, express or implied, by estoppel or otherwise, to any intellectual property rights is granted by this document.

THESE MATERIALS ARE PROVIDED "AS IS" WITHOUT WARRANTY OF ANY KIND, EITHER EXPRESS OR IMPLIED, RELATING TO SALE AND/OR USE OF MACOM PRODUCTS INCLUDING LIABILITY OR WARRANTIES RELATING TO FITNESS FOR A PARTICULAR PURPOSE, CONSEQUENTIAL OR INCIDENTAL DAMAGES, MERCHANTABILITY, OR INFRINGEMENT OF ANY PATENT, COPYRIGHT OR OTHER INTELLECTUAL PROPERTY RIGHT. MACOM FURTHER DOES NOT WARRANT THE ACCURACY OR COMPLETENESS OF THE INFORMATION, TEXT, GRAPHICS OR OTHER ITEMS CONTAINED WITHIN THESE MATERIALS. MACOM SHALL NOT BE LIABLE FOR ANY SPECIAL, INDIRECT, INCIDENTAL, OR CONSEQUENTIAL DAMAGES, INCLUDING WITHOUT LIMITATION, LOST REVENUES OR LOST PROFITS, WHICH MAY RESULT FROM THE USE OF THESE MATERIALS.

MACOM products are not intended for use in medical, lifesaving or life sustaining applications. MACOM customers using or selling MACOM products for use in such applications do so at their own risk and agree to fully indemnify MACOM for any damages resulting from such improper use or sale.