

NCL30386

Dimmable Power Factor Corrected LED Driver Featuring Primary Side CC / CV Control

The NCL30386 is a power factor corrected controller targeting isolated and non-isolated “smart-dimmable” constant-current LED drivers. Designed to support flyback, buck-boost and SEPIC topologies, the controller operates in a quasi-resonant mode to provide high efficiency. Thanks to a novel control method, the device is able to tightly regulate a constant LED current and voltage from the primary side. This removes the need for secondary-side feedback circuitry, its biasing and for an optocoupler. The device also provides near-unity power factor correction.

The device is highly integrated with a minimum number of external components. A robust suite of safety protection is built in to simplify the design. This device is specifically intended for very compact space efficient designs and supports analog and digital dimming with two dedicated dimming inputs control ideal for Smart LED Lighting applications.

Features

- High Voltage Startup
- Quasi-resonant Peak Current-mode Control Operation
- Primary Side Feedback
- CC / CV Control
- Tight LED Constant Current Regulation of $\pm 2\%$ Typical
- Digital Power Factor Correction
- Analog and Digital Dimming
- Cycle by Cycle Peak Current Limit
- Wide Operating V_{CC} Range
- -40 to $+125^{\circ}\text{C}$
- Robust Protection Features
 - ◆ Brown-Out
 - ◆ OVP on V_{CC}
 - ◆ Constant Voltage / LED Open Circuit Protection
 - ◆ Winding Short Circuit Protection
 - ◆ Secondary Diode Short Protection
 - ◆ Output Short Circuit Protection
 - ◆ Thermal Shutdown

Typical Applications

- Integral LED Bulbs
- LED Power Driver Supplies
- LED Light Engines



ON Semiconductor®

www.onsemi.com

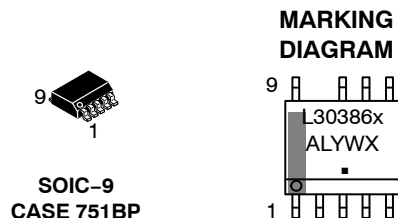

L30386 = Specific Device Code
x = Version
A = Assembly Location
L = Wafer Lot
Y = Year
W = Work Week
▪ = Pb-Free Package

PIN CONNECTIONS

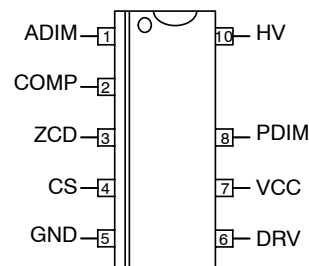

ORDERING INFORMATION

See detailed ordering and shipping information on page 18 of this data sheet.

NCL30386

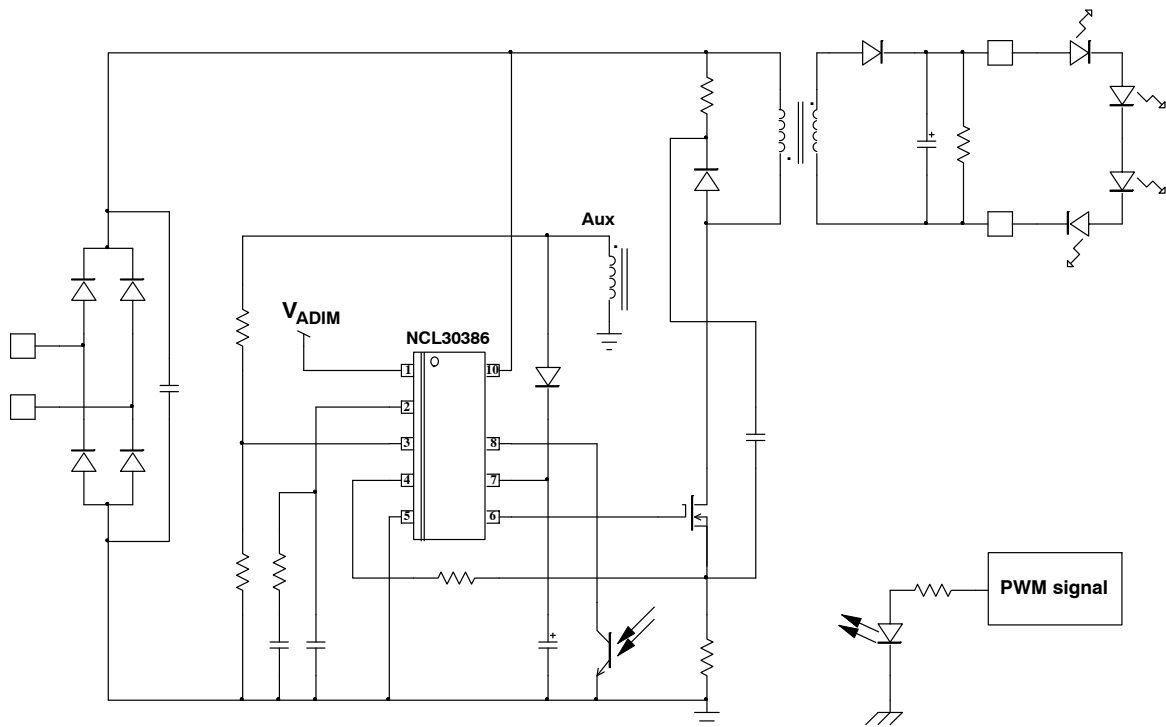

Figure 1. Typical Application Schematic for NCL30386

PIN FUNCTION DESCRIPTION NCL30386

| Pin N° | Pin Name | Function | Pin Description |
|--------|----------|--|---|
| 1 | ADIM | Analog dimming | This pin is used for analog control of the output current. Applying a voltage varying between $V_{DIM(EN)}$ and V_{DIM100} will dim the output current from 0.5% to 100%. |
| 2 | COMP | OTA output for CV loop | This pin receives a compensation network to stabilize the CV loop |
| 3 | ZCD | Zero crossing Detection V_{aux} sensing | This pin connects to the auxiliary winding and is used to detect the core reset event. This pin also senses the auxiliary winding voltage for accurate output voltage control |
| 4 | CS | Current sense | This pin monitors the primary peak current. |
| 5 | GND | - | The controller ground |
| 6 | DRV | Driver output | The driver's output to an external MOSFET |
| 7 | VCC | Supplies the controller | This pin is connected to an external auxiliary voltage. |
| 8 | PDIM | PWM dimming | This pin is used PWM dimming control. An optocoupler can be connected directly to the pin if the PWM control signal is from the secondary side |
| 9 | NC | creepage | |
| 10 | HV | High Voltage sensing | This pin connects after the diode bridge to provide the startup current and internal high voltage sensing function. |

INTERNAL CIRCUIT ARCHITECTURE

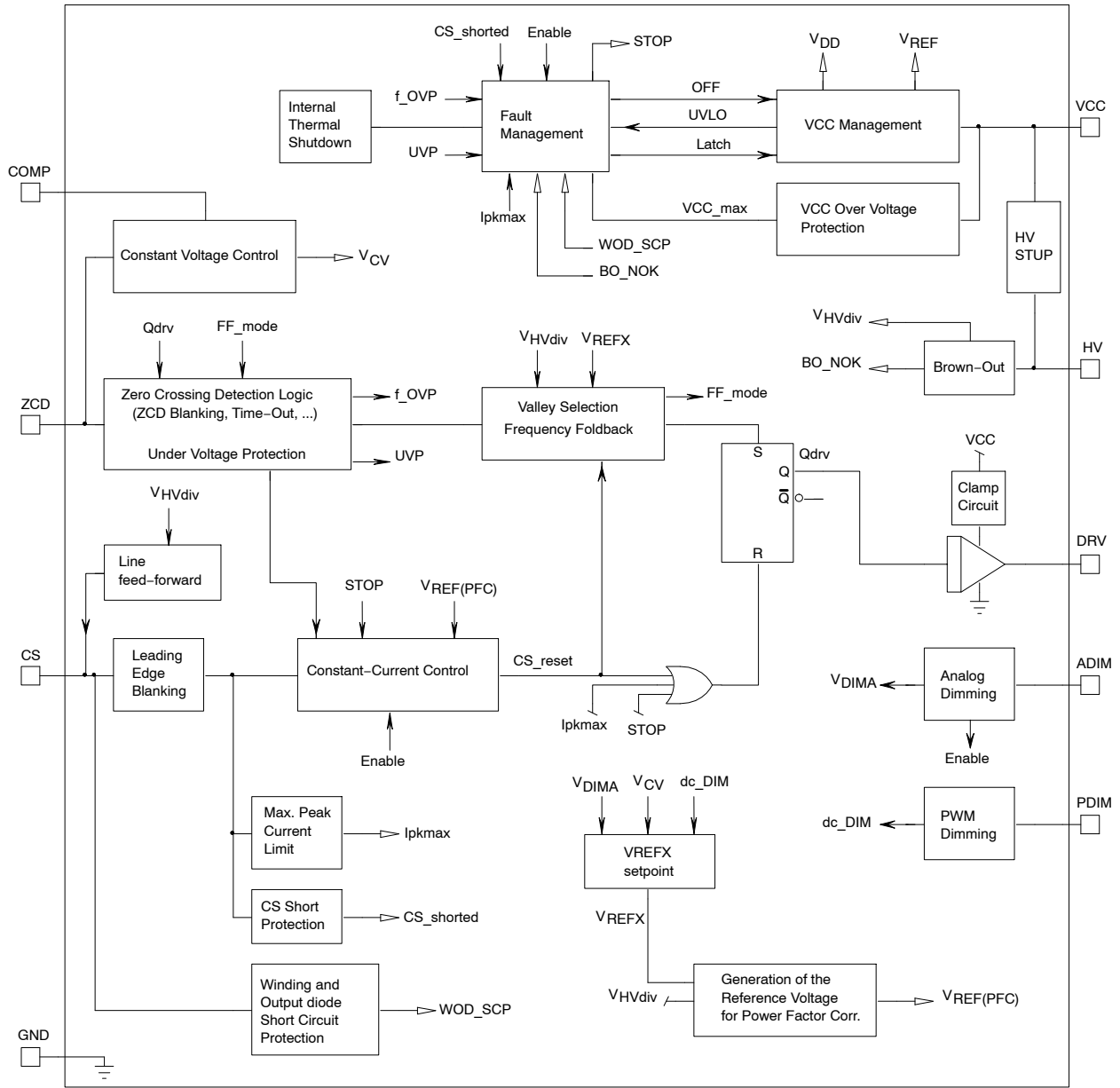

Figure 2. Internal Circuit Architecture NCL30386

MAXIMUM RATINGS TABLE

| Symbol | Rating | Value | Unit |
|--|---|---|---------|
| V _{CC(MAX)} I _{CC(MAX)} | Maximum Power Supply voltage, VCC pin, continuous voltage Maximum current for VCC pin | -0.3 to 30 Internally limited | V mA |
| V _{DRV(MAX)} I _{DRV(MAX)} | Maximum driver pin voltage, DRV pin, continuous voltage Maximum current for DRV pin | -0.3, V _{DRV} (Note 1) -300, +500 | V mA |
| V _{HV(MAX)} I _{HV(MAX)} | Maximum voltage on HV pin Maximum current for HV pin (dc current self-limited if operated within the allowed range) | -0.3, +700 ±20 | V mA |
| V _{MAX} I _{MAX} | Maximum voltage on low power pins (except pins HV, DRV and VCC) Current range for low power pins (except pins HV, DRV and VCC) | -0.3, 5.5 (Note 2) -2, +5 | V mA |
| R _{θJ-A} | Thermal Resistance Junction-to-Air | 180 | °C/W |
| T _{J(MAX)} | Maximum Junction Temperature | 150 | °C |
| | Operating Temperature Range | -40 to +125 | °C |
| | Storage Temperature Range | -60 to +150 | °C |
| | ESD Capability, HBM model except HV pin (Note 3) | 4 | kV |
| | ESD Capability, HBM model HV pin | 700 | V |
| | ESD Capability, MM model (Note 3) | 200 | V |
| | ESD Capability, CDM model (Note 3) | 1 | kV |

Stresses exceeding those listed in the Maximum Ratings table may damage the device. If any of these limits are exceeded, device functionality should not be assumed, damage may occur and reliability may be affected.

- V_{DRV} is the DRV clamp voltage V_{DRV(high)} when V_{CC} is higher than V_{DRV(high)}. V_{DRV} is V_{CC} otherwise.
- This level is low enough to guarantee not to exceed the internal ESD diode and 5.5 V ZENER diode. More positive and negative voltages can be applied if the pin current stays within the -2 mA / 5 mA range.
- This device series contains ESD protection and exceeds the following tests: Human Body Model 4000 V per Mil-Std-883, Method 3015. Charged Device Model 2000 V per JEDEC Standard JESD22-C101D.
- This device contains latch-up protection and exceeds 100 mA per JEDEC Standard JESD78.

ELECTRICAL CHARACTERISTICS (Unless otherwise noted: For typical values T_J = 25°C, V_{CC} = 12 V, V_{ZCD} = 0 V, V_{CS} = 0 V)
For min/max values T_J = -40°C to +125°C, Max T_J = 150°C, V_{CC} = 12 V)

| Description | Test Condition | Symbol | Min | Typ | Max | Unit |
|--|--|-------------------------|-----|-----|-----|------|
| HIGH VOLTAGE SECTION | | | | | | |
| High voltage current source | V _{CC} = V _{CC(on)} - 200 mV | I _{HV(start2)} | 3.3 | 4.7 | 6.1 | mA |
| High voltage current source | V _{CC} = 0 V | I _{HV(start1)} | | 300 | | µA |
| V _{CC} level for I _{HV(start1)} to I _{HV(start2)} transition | | V _{CC(TH)} | | 2 | | V |
| Minimum startup voltage | V _{CC} = 0 V | V _{HV(MIN)} | - | 17 | - | V |
| HV source leakage current | V _{HV} = 450 V | I _{HV(leak)} | | 4.5 | 10 | µA |
| Maximum rms input voltage for correct constant-current operation (T _J = -20°C to 125°C) | | V _{HV(OL)} | 265 | | | Vrms |

SUPPLY SECTION

| | | | | | | |
|---|---|---|-------------------------------|------------------------------|------------------------------|----|
| Supply Voltage Startup Threshold Threshold for turning off DSS (Note 5) Minimum Operating Voltage Hysteresis V _{CC(on)} - V _{CC(off)} Internal logic reset | V _{CC} increasing V _{CC} increasing V _{CC} decreasing V _{CC} decreasing | V _{CC(on)} V _{CC(on2)} V _{CC(off)} V _{CC(HYS)} V _{CC(reset)} | 16 9.77 8.2 7.8 4 | 18 10.80 8.6 - 5 | 20 11.24 9.4 - 6 | V |
| Over Voltage Protection VCC OVP threshold | | V _{CC(OVP)} | 25 | 26.5 | 28 | V |
| V _{CC(off)} noise filter (Note 6) V _{CC(reset)} noise filter (Note 6) | | t _{VCC(off)} t _{VCC(reset)} | - - | 5 20 | - - | µs |
| Supply Current Device Disabled/Fault Device Enabled/No output load on pin 5 Device Switching (F _{sw} = 65 kHz) Device switching (F _{sw} = 15 kHz) | V _{CC} > V _{CC(off)} F _{sw} = 65 kHz C _{DRV} = 470 pF, F _{sw} = 65 kHz V _{REFX} = 10% of max value | I _{CC1} I _{CC2} I _{CC3} I _{CC4} | 1.2 - - - | 1.5 3.0 3.3 2.9 | 1.8 3.5 4.0 3.4 | mA |

- Refer to ordering table option at the end of the document.
- Guaranteed by design.

NCL30386

ELECTRICAL CHARACTERISTICS (Unless otherwise noted: For typical values $T_J = 25^\circ\text{C}$, $V_{CC} = 12\text{ V}$, $V_{ZCD} = 0\text{ V}$, $V_{CS} = 0\text{ V}$)
For min/max values $T_J = -40^\circ\text{C}$ to $+125^\circ\text{C}$, Max $T_J = 150^\circ\text{C}$, $V_{CC} = 12\text{ V}$)

| Description | Test Condition | Symbol | Min | Typ | Max | Unit |
|-------------|----------------|--------|-----|-----|-----|------|
|-------------|----------------|--------|-----|-----|-----|------|

CURRENT SENSE

| | | | | | | |
|---|-----------------|-----------------|------|------|------|---------------|
| Maximum Internal current limit | | V_{ILIM} | 1.31 | 1.38 | 1.45 | V |
| Leading Edge Blanking Duration for V_{ILIM} | | t_{LEB} | 270 | 330 | 390 | ns |
| Propagation delay from current detection to gate off-state | | t_{ILIM} | - | 100 | 150 | ns |
| Maximum on-time (option B) | | $t_{on(MAX)}$ | 29 | 39 | 49 | μs |
| Maximum on-time (option A) | | $t_{on(MAX2)}$ | 16 | 20 | 24 | μs |
| Threshold for immediate fault protection activation (140% of V_{ILIM}) | | $V_{CS(stop)}$ | 1.91 | 1.99 | 2.07 | V |
| Leading Edge Blanking Duration for $V_{CS(stop)}$ | | t_{BCS} | - | 170 | - | ns |
| Current source for CS to GND short detection | | $I_{CS(short)}$ | 400 | 500 | 600 | μA |
| Current sense threshold for CS to GND short detection | V_{CS} rising | $V_{CS(low)}$ | 20 | 60 | 100 | mV |

GATE DRIVE

| | | | | | | |
|--|---|------------------------|--------|------------|--------|----------|
| Drive Resistance DRV Sink DRV Source | | R_{SNK} R_{SRC} | - - | 13 30 | - - | Ω |
| Drive current capability DRV Sink (Note GBD) DRV Source (Note GBD) | | I_{SNK} I_{SRC} | - - | 500 300 | - - | mA |
| Rise Time (10 % to 90 %) | $C_{DRV} = 470\text{ pF}$ | t_r | - | 30 | - | ns |
| Fall Time (90 % to 10 %) | $C_{DRV} = 470\text{ pF}$ | t_f | - | 20 | - | ns |
| DRV Low Voltage | $V_{CC} = V_{CC(off)} + 0.2\text{ V}$ $C_{DRV} = 470\text{ pF}$, $R_{DRV} = 33\text{ k}\Omega$ | $V_{DRV(low)}$ | 8 | - | - | V |
| DRV High Voltage | $V_{CC} = V_{CC(MAX)}$ $C_{DRV} = 470\text{ pF}$, $R_{DRV} = 33\text{ k}\Omega$ | $V_{DRV(high)}$ | 10 | 12 | 14 | V |

ZERO VOLTAGE DETECTION CIRCUIT

| | | | | | | |
|---|------------------------------|--------------------|------|-----|------|---------------|
| Upper ZCD threshold voltage | V_{ZCD} rising | $V_{ZCD(rising)}$ | - | 90 | 150 | mV |
| Lower ZCD threshold voltage | V_{ZCD} falling | $V_{ZCD(falling)}$ | 35 | 55 | - | mV |
| ZCD hysteresis | | $V_{ZCD(HYS)}$ | 15 | - | - | mV |
| Propagation Delay from valley detection to DRV high | V_{ZCD} decreasing | $t_{ZCD(DEM)}$ | - | - | 150 | ns |
| Blanking delay after on-time (ZCD blank option B) | $V_{REFX} > 0.35\text{ V}$ | $t_{ZCD(blank1)B}$ | 1.1 | 1.5 | 1.9 | μs |
| Blanking Delay at light load (ZCD blank option B) | $V_{REFX} < 0.25\text{ V}$ | $t_{ZCD(blank2)B}$ | 0.6 | 0.8 | 1.0 | μs |
| Blanking delay after on-time (ZCD blank option A) | $V_{REFX} > 0.35\text{ V}$ | $t_{ZCD(blank1)A}$ | 0.75 | 1.0 | 1.25 | μs |
| Blanking Delay at light load (ZCD blank option A) | $V_{REFX} < 0.25\text{ V}$ | $t_{ZCD(blank2)A}$ | 0.45 | 0.6 | 0.75 | μs |
| Timeout after last DEMAG transition | | t_{TIMO} | 5 | 6.5 | 8 | μs |
| Pulling-down resistor | $V_{ZCD} = V_{ZCD(falling)}$ | $R_{ZCD(pd)}$ | | 200 | | k Ω |

CONSTANT CURRENT CONTROL

| | | | | | | |
|--|------------------|---------------|-------|-------|-------|----|
| Reference Voltage at $T_J = 25^\circ\text{C}$ to 100°C | | V_{REF} | 326 | 333 | 340 | mV |
| Reference Voltage $T_J = -40^\circ\text{C}$ to 125°C | | V_{REF} | 323 | 333 | 343 | mV |
| 10% reference Voltage ($T_J = 25^\circ\text{C}$ to 85°C) | | V_{REF10} | 23.45 | 33.50 | 43.55 | mV |
| 10% reference Voltage ($T_J = -40^\circ\text{C}$ to 125°C) | | V_{REF10} | 21.77 | 33.50 | 45.23 | mV |
| Current sense lower threshold for detection of the leakage inductance reset time | V_{CS} falling | $V_{CS(low)}$ | 20 | 50 | 100 | mV |
| Blanking time for leakage inductance reset detection | | $t_{CS(low)}$ | - | 120 | - | ns |

CONSTANT VOLTAGE SECTION

| | | | | | | |
|--|--|---------------|------|------|------|---|
| Internal voltage reference for constant voltage regulation $T_J = 25^\circ\text{C}$ | | $V_{REF(CV)}$ | 2.42 | 2.48 | 2.54 | V |
|--|--|---------------|------|------|------|---|

NCL30386

ELECTRICAL CHARACTERISTICS (Unless otherwise noted: For typical values $T_J = 25^\circ\text{C}$, $V_{CC} = 12\text{ V}$, $V_{ZCD} = 0\text{ V}$, $V_{CS} = 0\text{ V}$)
For min/max values $T_J = -40^\circ\text{C}$ to $+125^\circ\text{C}$, Max $T_J = 150^\circ\text{C}$, $V_{CC} = 12\text{ V}$)

| Description | Test Condition | Symbol | Min | Typ | Max | Unit |
|---|--|--|-------|--|-------|-----------------|
| CONSTANT VOLTAGE SECTION | | | | | | |
| Internal voltage reference for constant voltage regulation $T_J = -40^\circ\text{C}$ to 125°C | | $V_{REF(CV)}$ | 2.38 | 2.48 | 2.58 | V |
| CV Error amplifier Gain | | G_{EA} | 40 | 50 | 60 | μS |
| Error amplifier current capability | $V_{REFX}=V_{REF}$ | I_{EA} | | ± 60 | | μA |
| COMP pin lower clamp voltage | | $V_{CV(\text{clampL})}$ | | 0.6 | | V |
| COMP pin higher clamp voltage | | $V_{CV(\text{clampH})}$ | | 4.1 | | V |
| ZCD pin voltage below which the CV OTA is boosted | $V_{REF(CV)} * 80\%$ | $V_{\text{boost}(CV)}$ | 1.88 | 2 | 2.12 | V |
| Error amplifier current capability during boost phase | | $I_{EA\text{boost}}$ | | ± 140 | | μA |
| ZCD slow OVP threshold ($V_{ref(CV)} * 115\%$) | | V_{OVP1} | 2.69 | 2.87 | 3.04 | V |
| Switching period during slow OVP | | $T_{sw(OVP1)}$ | | 1.5 | | ms |
| ZCD voltage at which slow OVP is exit ($V_{ref(CV)} * 105\%$) | | $V_{OVP1rst}$ | | 2.625 | | V |
| ZCD fast OVP threshold ($V_{ref(CV)} * 130\%$) | | V_{OVP2} | 3.29 | 3.43 | 3.57 | V |
| LINE FEED FORWARD | | | | | | |
| V_{VS} to $I_{CS(\text{offset})}$ conversion ratio | | K_{LFF} | 0.153 | 0.185 | 0.217 | $\mu\text{A/V}$ |
| Offset current maximum value | $V_{HV} > (450\text{ V or } 500\text{ V})$ | $I_{\text{offset}(\text{MAX})}$ | 76 | 95 | 114 | μA |
| Line feed-forward current | DRV high, $V_{HV} = 200\text{ V}$ | I_{FF} | 32 | 37 | 42 | μA |
| VALLEY LOCKOUT SECTION | | | | | | |
| Threshold for line range detection V_{HV} increasing | V_{HV} increases | V_{HL} | 252 | 264 | 276 | V |
| Threshold for line range detection V_{HV} decreasing | V_{HV} decreases | V_{LL} | 241 | 253 | 265 | V |
| Blanking time for line range detection | | $t_{HL(\text{blank})}$ | 15 | 25 | 35 | ms |
| Valley thresholds (expressed as a percentage of V_{REF}) 1 st to 2 nd valley transition at LL and 2 nd to 3 rd valley HL, V_{REF} decr. 2 nd to 1 st valley transition at LL and 3 rd to 2 nd valley HL, V_{REF} incr. 2 nd to 3 rd valley transition at LL and 3 rd to 4 th valley HL, V_{REF} decr. 3 rd to 2 nd valley transition at LL and 4 th to 3 rd valley HL, V_{REF} incr. 3 rd to 4 th valley transition at LL and 4 th to 5 th valley HL, V_{REF} decr. 4 th to 3 rd valley transition at LL and 5 th to 4 th valley HL, V_{REF} incr. 4 th to 5 th valley transition at LL and 5 th to 6 th valley HL, V_{REF} decr. 5 th to 4 th valley transition at LL and 6 th to 5 th valley HL, V_{REF} incr. | V_{REF} decreases V_{REF} increases V_{REF} decreases V_{REF} increases V_{REF} decreases V_{REF} increases V_{REF} decreases V_{REF} increases V_{REF} decreases V_{REF} increases | $V_{VLY1-2/2-3}$ $V_{VLY2-1/3-2}$ $V_{VLY2-3/3-4}$ $V_{VLY3-2/4-3}$ $V_{VLY3-4/4-5}$ $V_{VLY4-3/5-4}$ $V_{VLY4-5/5-6}$ $V_{VLY5-4/6-5}$ | | 80 90 65 75 50 60 35 45 | | % |
| V_{REF} value at which the FF mode is activated | V_{REF} decreases | $V_{FFstart}$ | | 25 | | % |
| V_{REF} value at which the FF mode is removed | V_{REF} increases | V_{FFstop} | | 35 | | % |
| FREQUENCY FOLDBACK | | | | | | |
| Added dead time | $V_{REFX} = 25\% V_{REF}$ | t_{FF1LL} | 1.4 | 2.0 | 2.6 | μS |
| Added dead time | $V_{REFX} = 8\% V_{REF}$ | t_{FFchg} | - | 40 | - | μS |
| Dead-time clamp (Maximum dead-time option C) | $V_{REFX} < 1\text{ mV}$ | t_{FFend} | | 1.4 | - | ms |
| Dead-time clamp (Maximum dead-time option B) | $V_{REFX} < 3\text{ mV}$ | t_{FFend2} | - | 687 | - | μS |
| Dead-time clamp (Maximum dead-time option A) | $V_{REFX} < 11.2\text{ mV}$ | t_{FFend3} | - | 250 | - | μS |
| DIMMING SECTION | | | | | | |
| DIM pin voltage for zero output current (OFF voltage) | | $V_{ADIM(EN)}$ | 0.475 | 0.5 | 0.525 | V |
| ADIM pin voltage for 0.5% reference voltage | | $V_{ADIM(MIN)}$ | 0.67 | 0.7 | 0.73 | V |
| Minimum dimming level (dimming lower clamp option Y) | | $K_{DIM(MIN)}$ | | 0.5 | | % |
| ADIM pin voltage for maximum output current ($V_{REFX} = 1\text{ V}$) | | $V_{ADIM100}$ | - | 3.0 | 3.1 | V |
| Dimming range | | $V_{ADIM(\text{range})}$ | | 2.3 | | V |
| Clamping voltage for DIM pin | | $V_{ADIM(\text{CLP})}$ | | 6.8 | | V |
| Dimming pin pull-up current source | | $I_{ADIM(\text{pullup})}$ | 8 | 10 | 12 | μA |
| Current Comparator threshold for PDIM | I_{PDIM} rising | $I_{PDIM(THR)}$ | 60 | 70 | 80 | μA |
| Current Comparator threshold for PDIM | I_{PDIM} falling | $I_{PDIM(THD)}$ | 86 | 100 | 114 | μA |

NCL30386

ELECTRICAL CHARACTERISTICS (Unless otherwise noted: For typical values $T_J = 25^\circ\text{C}$, $V_{CC} = 12\text{ V}$, $V_{ZCD} = 0\text{ V}$, $V_{CS} = 0\text{ V}$)
 For min/max values $T_J = -40^\circ\text{C}$ to $+125^\circ\text{C}$, Max $T_J = 150^\circ\text{C}$, $V_{CC} = 12\text{ V}$)

| Description | Test Condition | Symbol | Min | Typ | Max | Unit |
|-------------|----------------|--------|-----|-----|-----|------|
|-------------|----------------|--------|-----|-----|-----|------|

DIMMING SECTION

| | | | | | | |
|--------------------------------|--|-----------------|-----|-----|-----|---------------|
| Cascode current limit for PDIM | | $I_{PDIM(LIM)}$ | 510 | 600 | 690 | μA |
| PDIM pin voltage | | V_{PDIM} | - | 3 | | V |

FAULT PROTECTION

| | | | | | | |
|--|--|------------------|-----|-----|-----|------------------|
| Thermal Shutdown | Device switching (F_{SW} around 65 kHz) | T_{SHDN} | 130 | 150 | 170 | $^\circ\text{C}$ |
| Thermal Shutdown Hysteresis | | $T_{SHDN(HYS)}$ | - | 50 | - | $^\circ\text{C}$ |
| Threshold voltage for output short circuit or aux. winding short circuit detection | | $V_{ZCD(short)}$ | 0.8 | 1.0 | 1.2 | V |
| Short circuit detection Timer | $V_{ZCD} < V_{ZCD(short)}$ | $t_{OVL D}$ | 70 | 90 | 110 | ms |
| Auto-recovery Timer | | $t_{recovery}$ | 3 | 4 | 5 | s |

BROWN-OUT AND LINE SENSING

| | | | | | | |
|---|---------------------|-----------------|-----|-----|-----|---------------|
| Brown-Out ON level (IC start pulsing) | V_{HV} increasing | $V_{HVBO(on)}$ | 104 | 110 | 116 | V |
| Brown-Out OFF level (IC stops pulsing) | V_{HV} decreasing | $V_{HVBO(off)}$ | 93 | 99 | 105 | V |
| BO comparators delay | | $t_{BO(delay)}$ | | 30 | | μs |
| Brown-Out blanking time | | $t_{BO(blank)}$ | 15 | 25 | 35 | ms |
| HV pin voltage above which the sampling of ZCD is enabled | V_{HV} decreasing | V_{sampEN} | | 61 | | V |
| Sampling Enable comparator hysteresis | V_{HV} increasing | $V_{sampHYS}$ | | 4 | | V |

TYPICAL CHARACTERISTICS

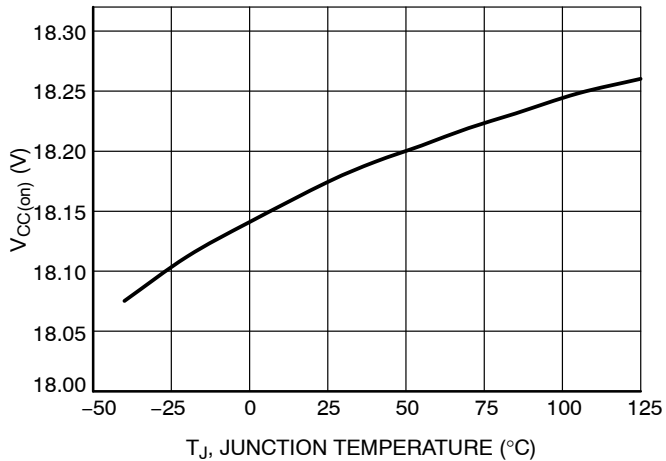

Figure 3. $V_{CC(on)}$ vs. Junction Temperature

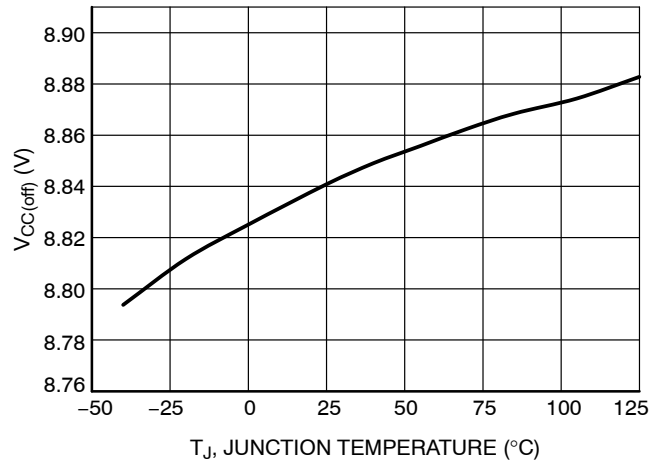

Figure 4. $V_{CC(off)}$ vs. Junction Temperature

TYPICAL CHARACTERISTICS

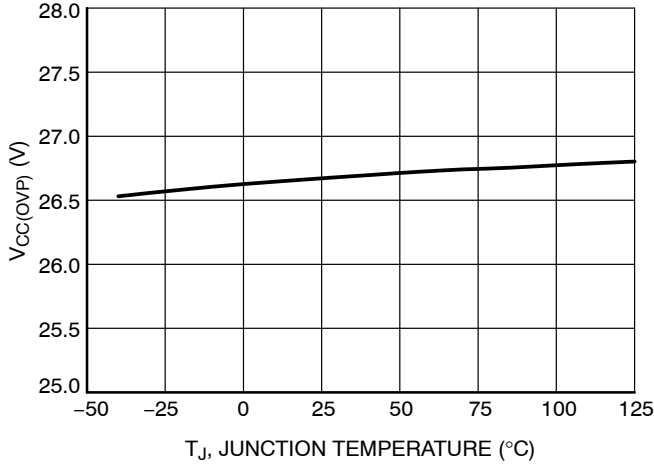

Figure 5. $V_{CC(OVP)}$ vs. Junction Temperature

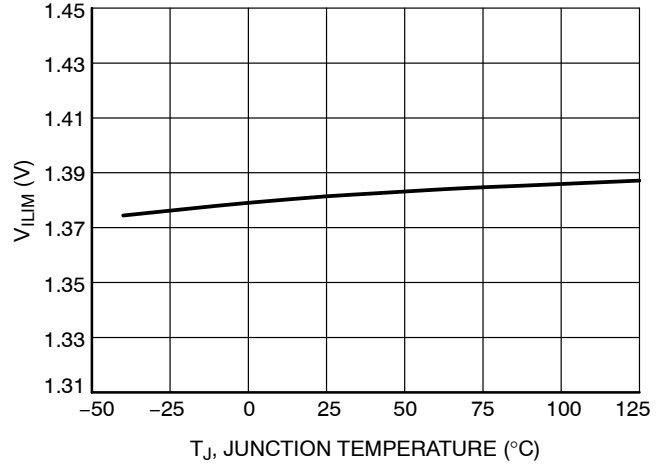

Figure 6. V_{ILIM} vs. Junction Temperature

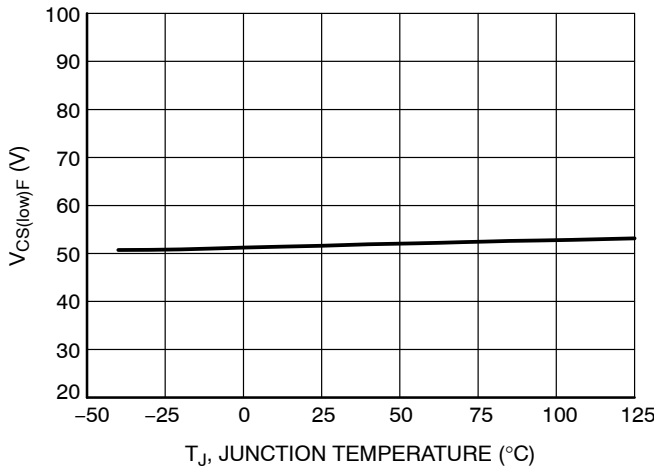

Figure 7. $V_{CS(low)F}$ vs. Junction Temperature

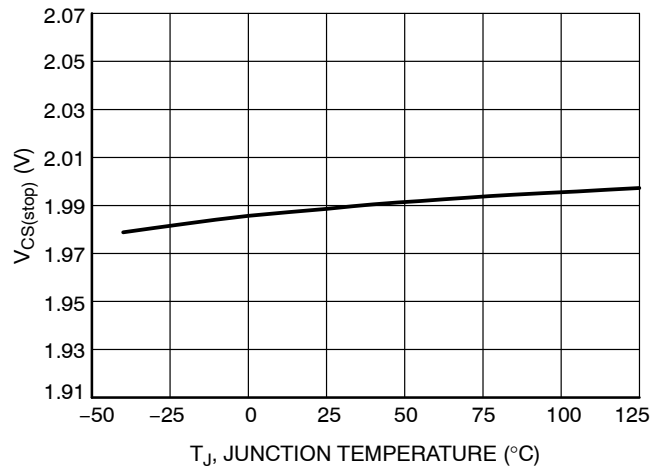

Figure 8. $V_{CS(stop)}$ vs. Junction Temperature

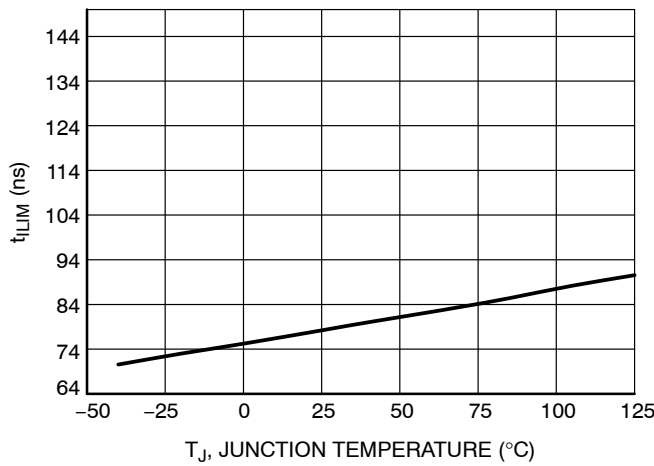

Figure 9. t_{ILIM} vs. Junction Temperature

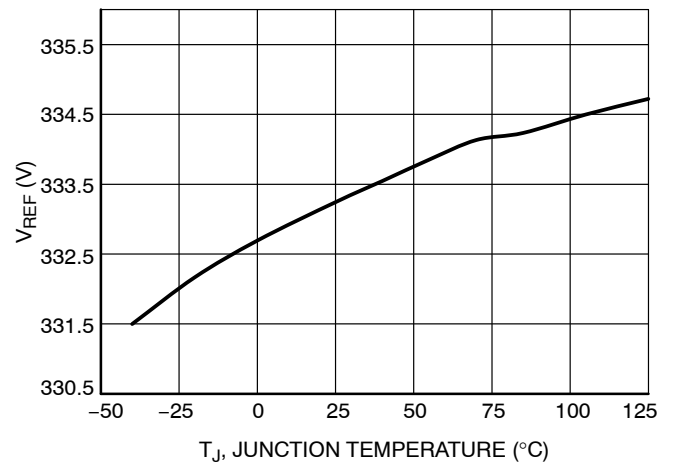

Figure 10. V_{REF} vs. Junction Temperature

TYPICAL CHARACTERISTICS

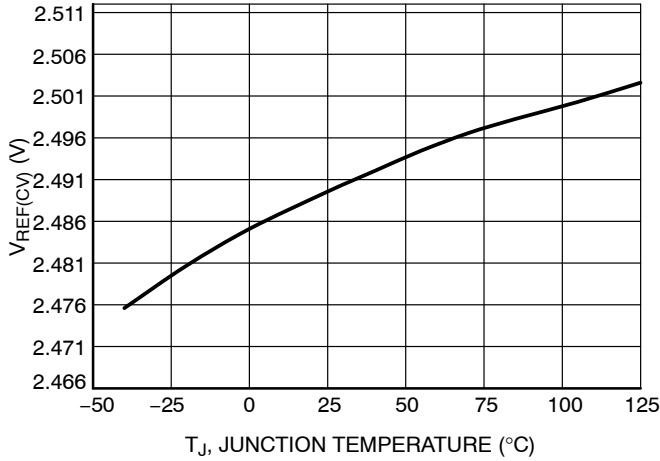

Figure 11. V_{REF(CV)} vs. Junction Temperature

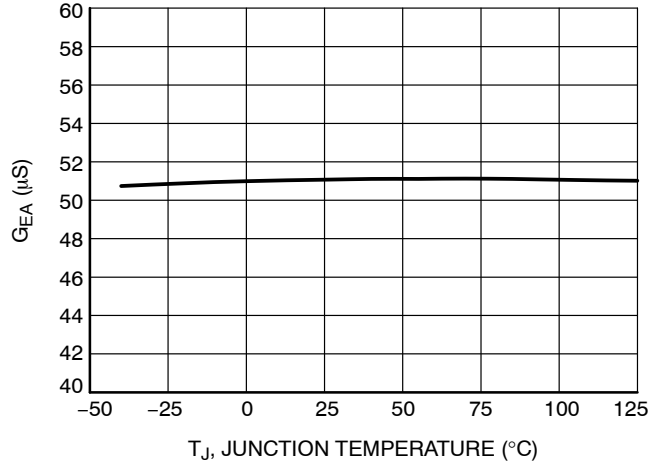

Figure 12. G_{EA} vs. Junction Temperature

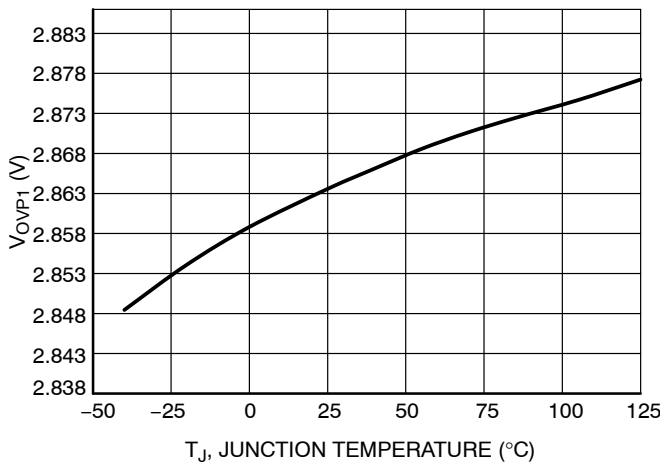

Figure 13. V_{OVP1} vs. Junction Temperature

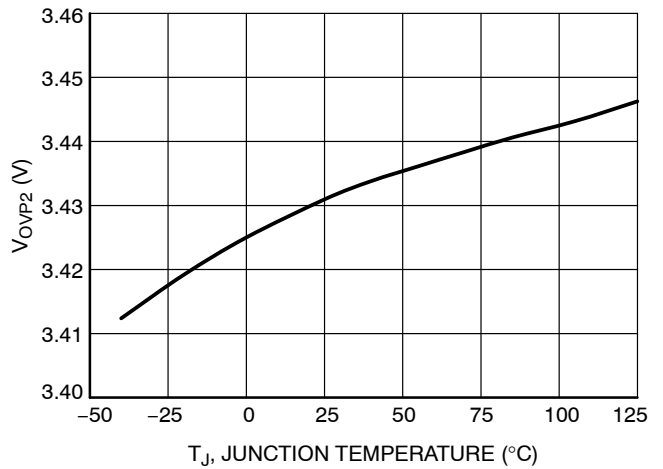

Figure 14. V_{OVP2} vs. Junction Temperature

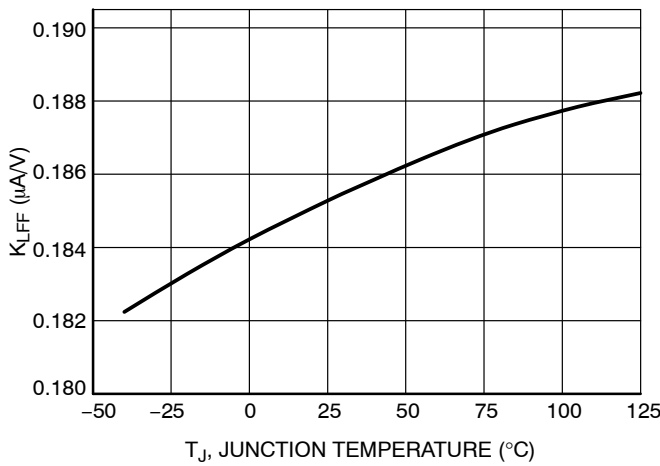

Figure 15. K_{LFF} vs. Junction Temperature

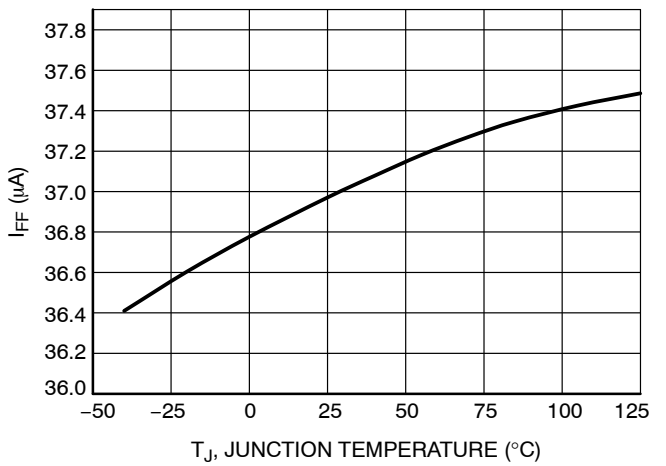

Figure 16. I_{FF} vs. Junction Temperature

TYPICAL CHARACTERISTICS

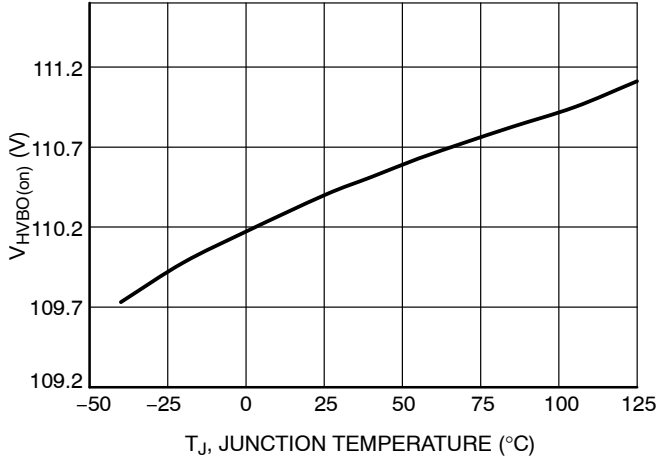

Figure 17. $V_{HVBO(on)}$ vs. Junction Temperature

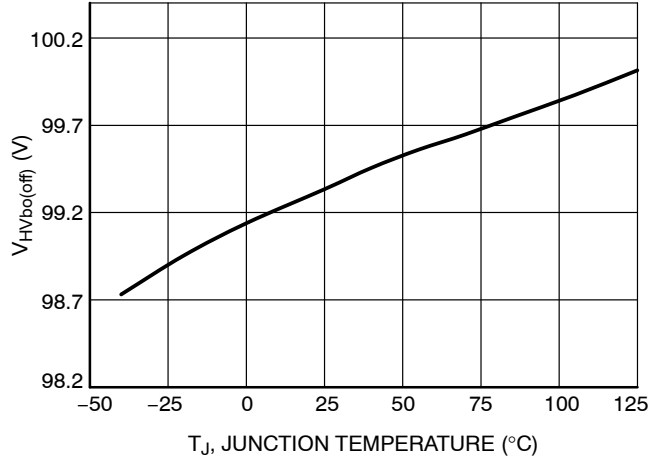

Figure 18. $V_{HVbo(off)}$ vs. Junction Temperature

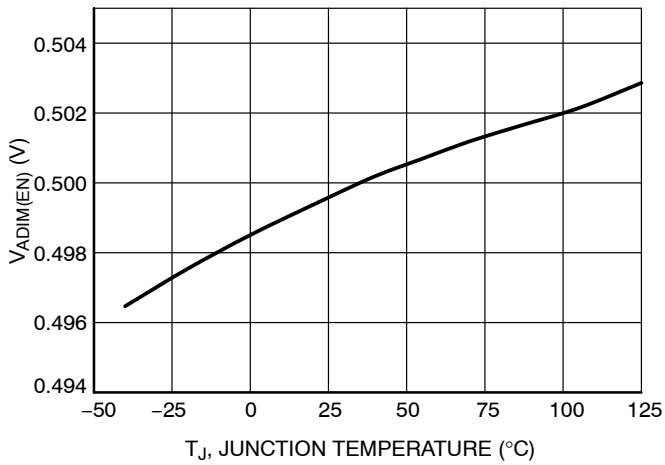

Figure 19. $V_{ADIM(EN)}$ vs. Junction Temperature

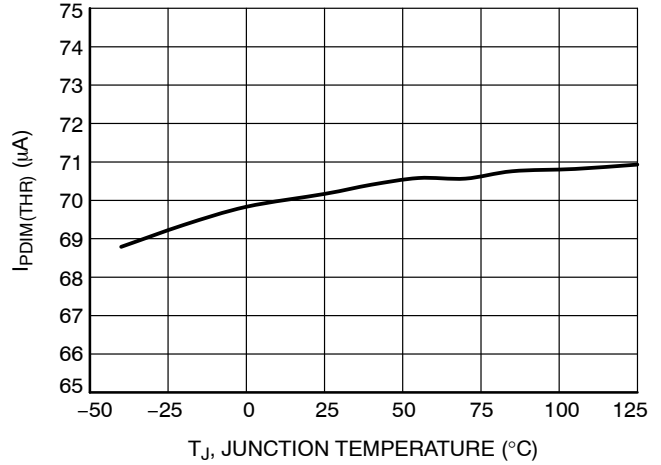

Figure 20. $I_{PDIM(THR)}$ vs. Junction Temperature

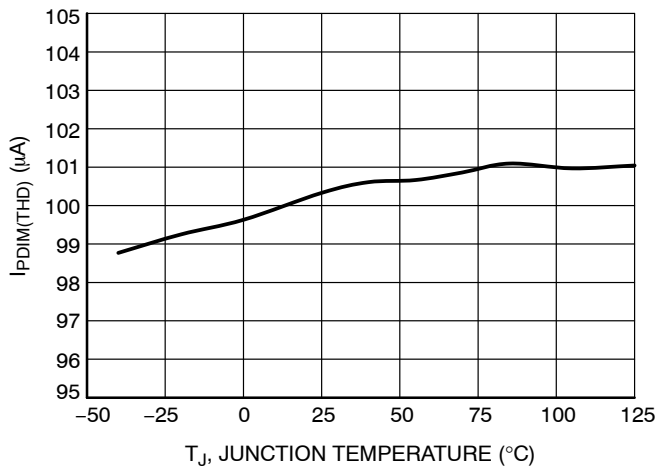

Figure 21. $I_{PDIM(THD)}$ vs. Junction Temperature

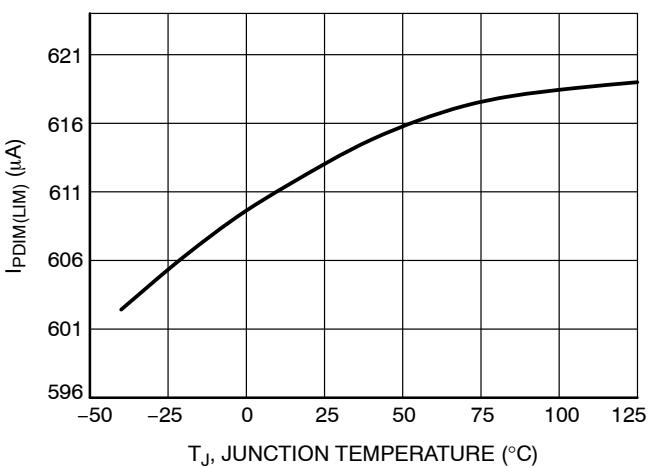

Figure 22. $I_{PDIM(LIM)}$ vs. Junction Temperature

APPLICATION INFORMATION

The NCL30386 implements a current-mode architecture operating in quasi-resonant mode. Thanks to proprietary circuitry, the controller is able to accurately regulate the secondary side current and voltage of the fly-back converter without using any opto-coupler or measuring directly the secondary side current or voltage. The controller provides near unity power factor correction

- **Quasi-Resonance Current-Mode Operation:** implementing quasi-resonance operation in peak current-mode control, the NCL30386 optimizes the efficiency by switching in the valley of the MOSFET drain-source voltage. Thanks to an internal algorithm control, the controller locks-out in a selected valley and remains locked until the input voltage or the output current set point significantly changes.
- **Primary Side Constant Current Control:** thanks to a proprietary circuit, the controller is able to take into account the effect of the leakage inductance of the transformer and allows an accurate control of the secondary side current regardless of the input voltage and output load variation
- **Primary Side Constant Voltage Regulation:** By monitoring the auxiliary winding voltage, it is possible to regulate accurately the output voltage. The output voltage regulation is typically within $\pm 2\%$.
- **Load Transient Compensation:** Since PFC has low loop bandwidth, abrupt changes in the load may cause excessive over or under-shoot. The slow Over Voltage Protection contains the output voltage when it tends to become excessive. In addition, the NCL30386 speeds up the constant voltage regulation loop when the output voltage goes below 80% of its regulation level.
- **Power Factor Correction:** A proprietary concept allows achieving high power factor correction and low THD while keeping accurate constant current and constant voltage control.
- **Line Feed-forward:** allows compensating the variation of the output current caused by the propagation delay.
- **V_{CC} Over Voltage Protection:** if the V_{CC} pin voltage exceeds an internal limit, the controller shuts down and waits 4 seconds before restarting pulsing.
- **Fast Over Voltage Protection:** If the voltage of ZCD pin exceeds 130% of its regulation level, the controller shuts down and waits 4 s before trying to restart.
- **Brown-Out:** the controller includes a brown-out circuit which safely stops the controller in case the input voltage is too low. The device will automatically restart if the line recovers.
- **Cycle-by-cycle peak current limit:** when the current sense voltage exceeds the internal threshold V_{ILIM}, the MOSFET is turned off for the rest of the switching cycle.
- **Winding Short-Circuit Protection:** an additional comparator senses the CS signal and stops the controller if V_{CS} reaches 1.5 x V_{ILIM} (after a reduced LEB of t_{BCS}). This additional comparator is enabled only during the main LEB duration t_{LEB}, for noise immunity reason.
- **Output Under Voltage Protection:** If a too low voltage is applied on ZCD pin for 90-ms time interval, the controllers assume that the output or the ZCD pin is shorted to ground and shutdown. After waiting 4 seconds, the IC restarts switching.
- **Analog Dimming:** the ADIM pin is dedicated to analog dimming. The minimum dimming level is fixed 0.5% of the maximum output current. If a voltage lower than V_{ADIM(EN)} is applied on the pin, the controller is disabled.
- **PWM dimming:** the PDIM pin is dedicated to PWM dimming. The controller measures the duty ratio of a signal applied to the pin and reduces the output current accordingly. The PWM dimming signal is transform into an analog signal internally, and the LED current is controlled in an analog way.
- **Thermal Shutdown:** an internal circuitry disables the gate drive when the junction temperature exceeds 150°C (typically). The circuit resumes operation once the temperature drops below approximately 100°C.
- **Dynamic Self Supply option:** the dynamic self-supply keeps the controller alive in case of low dimming. If V_{CC} reaches V_{CC(off)}, the HV current source is turned on to charge V_{CC} capacitor until the voltage reaches V_{CC(on2)} without interrupting the DRV pulses.

POWER FACTOR AND CONSTANT CURRENT CONTROL

The NCL30386 embeds an analog/digital block to control the power factor and regulate the output current by monitoring the ZCD, CS and HV pin voltages (signals V_{ZCD} , V_{HV_DIV} , V_{CS}). This circuit generates the current setpoint V_{CTRL_DIV} and compares it to the current sense signal to turn the MOSFET off. The HV pin provides the sinusoidal reference necessary for shaping the input current. The obtained current reference is further modulated so that when averaged over a half line period, it is equal to the output current reference (V_{REFX}). The modulation and averaging process is made internally by a digital circuit. If the HV pin properly conveys the sinusoidal shape, power factor will be close to 1. Also, the Total Harmonic Distortion (THD) will be low especially if the output voltage ripple is small.

The output current will be well regulated, following the equation below:

$$I_{OUT} = \frac{V_{REFX}}{2N_{sp}R_{sense}} \quad (\text{eq. 1})$$

Where:

- ◆ N_{sp} is the secondary to primary transformer turns ratio: $N_{sp} = N_S / N_P$

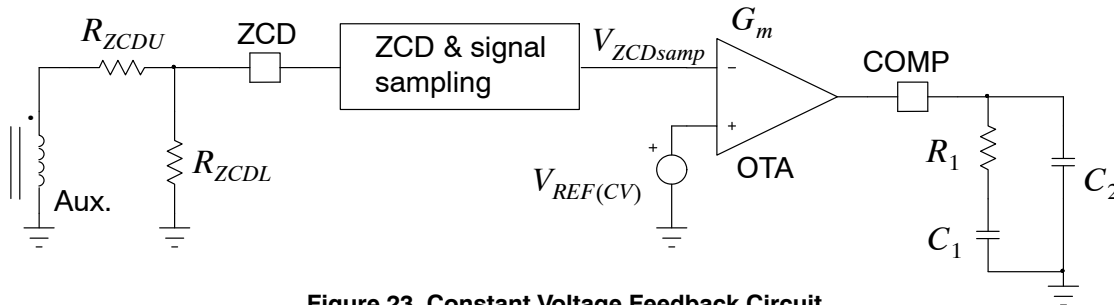

Figure 23. Constant Voltage Feedback Circuit

STARTUP PHASE (HV STARTUP)

It is generally requested that the LED driver starts to emit light in less than 1 s and possibly within 300 ms. It is challenging since the start-up consists of the time to charge the V_{CC} capacitor and that necessary to charge the output capacitor until sufficient current flows into the LED string. This second phase can be particularly long in dimming cases where the secondary current is a portion of the nominal one.

The NCL30386/88 features a high voltage startup circuit that allows charging V_{CC} capacitor very fast.

When the power supply is first connected to the mains outlet, the internal current source is biased and charges up the V_{CC} capacitor. When the voltage on this V_{CC} capacitor reaches the $V_{CC(on)}$ level, the current source turns off. At this time, the controller is only supplied by the V_{CC} capacitor, and the auxiliary supply should take over before V_{CC} collapses below $V_{CC(off)}$.

The HV startup circuitry is made of two startup current levels, $I_{HV(start1)}$ and $I_{HV(start2)}$. This helps to protect the

- ◆ R_{sense} is the current sense resistor
- ◆ V_{REFX} is the output current reference: $V_{REFX} = V_{REF}$ if no dimming

The output current reference (V_{REFX}) is V_{REF} unless the constant voltage mode is activated or ADIM pin voltage is below $V_{ADIM(100)}$ or a PWM signal with a duty-cycle below 95% is applied on PDIM.

CONSTANT VOLTAGE CONTROL

The auxiliary winding voltage is sampled internally through the ZCD pin.

A precise internal voltage reference $V_{REF(CV)}$ sets the voltage target for the CV loop.

The sampled voltage is applied to the negative input of the CV OTA and compared to $V_{REF(CV)}$.

A type 2 compensator is needed at the CV OTA output to stabilize the loop. The COMP pin voltage modify the the output current internal reference in order to regulate the output voltage.

When $V_{COMP} \geq 4 \text{ V}$, $V_{REFX} = V_{REF}$.

When $V_{COMP} < 0.6 \text{ V}$, $V_{REFX} = 0 \text{ V}$

controller against short-circuit between V_{CC} and GND. At power-up, as long as V_{CC} is below $V_{CC(TH)}$, the source delivers $I_{HV(start1)}$ (around 300 μA typical). Then, when V_{CC} reaches $V_{CC(TH)}$, the source smoothly transitions to $I_{HV(start2)}$ and delivers its nominal value. As a result, in case of short-circuit between V_{CC} and GND occurring at high line ($V_{in} = 265 \text{ Vrms}$), the power dissipation will be $375 \times 300\mu = 112 \text{ mW}$ instead of 1.5 W if there was only one startup current level.

To speed-up the output voltage rise, the following is implemented:

- The digital OTA output is increased until $V_{REF(PFC)}$ signal reaches V_{REFX} . Again, this is to speed-up the control signal rise to their steady state value.
- At the beginning of each operating phase of a V_{CC} cycle, the digital OTA output is set to 0. Actually, the digital OTA output is set to 0 in the case of a cold start-up or in the case of a start-up sequence following

an operation interruption due to a fault. On the other hand, if the V_{CC} hiccups just because the system fails to start-up in one V_{CC} cycle (DSS option not activated), the digital OTA output is not reset to ease the second (or more) attempt.

- If the load is shorted, the circuit will operate in hiccup mode with V_{CC} oscillating between $V_{CC(off)}$ and $V_{CC(on)}$ until the output under voltage protection (UVP) trips. UVP is triggered if the ZCD pin voltage does not exceed 1 V within a 90 ms operation of time. This indicates that the ZCD pin is shorted to ground or that an excessive load prevents the output voltage from rising.

CYCLE-BY-CYCLE CURRENT LIMIT

When the current sense voltage exceeds the internal threshold V_{ILIM} , the MOSFET is turned off for the rest of the switching cycle.

WINDING AND OUTPUT DIODE SHORT-CIRCUIT PROTECTION

In parallel to the cycle-by-cycle sensing of the CS pin, another comparator with a reduced LEB (t_{BCS}) and a

threshold of ($V_{CS(stop)} = 140\% * V_{ILIM}$) monitors the CS pin to detect a winding or an output diode short circuit. The controller shuts down if it detects 4 consecutive pulses during which the CS pin voltage exceeds $V_{CS(stop)}$.

The controller goes into auto-recovery mode.

PWM DIMMING

The NCL30386 has a dedicated pin for PWM dimming.

The controller directly measures the duty ratio of a PWM signal applied to PDIM.

Two counters with a high frequency clock are used for this purpose. A first counter measure the high state duration of the PWM signal (t_{on_PDIM}) and the second counter measures its period (T_{sw_PDIM}). A divider computes ($t_{on_PDIM} / T_{sw_PDIM}$) and the result is directly the output current setpoint (V_{REFX} set point). A filter is added after the digital divider to remove the ripple of the signal. A cascode configuration on PDIM pin allows decreasing the fall time of the signal.

Due to this circuit, the LED current is controlled in an analog way, even if a PWM signal is used for dimming. This allows having a good PF during dimming.

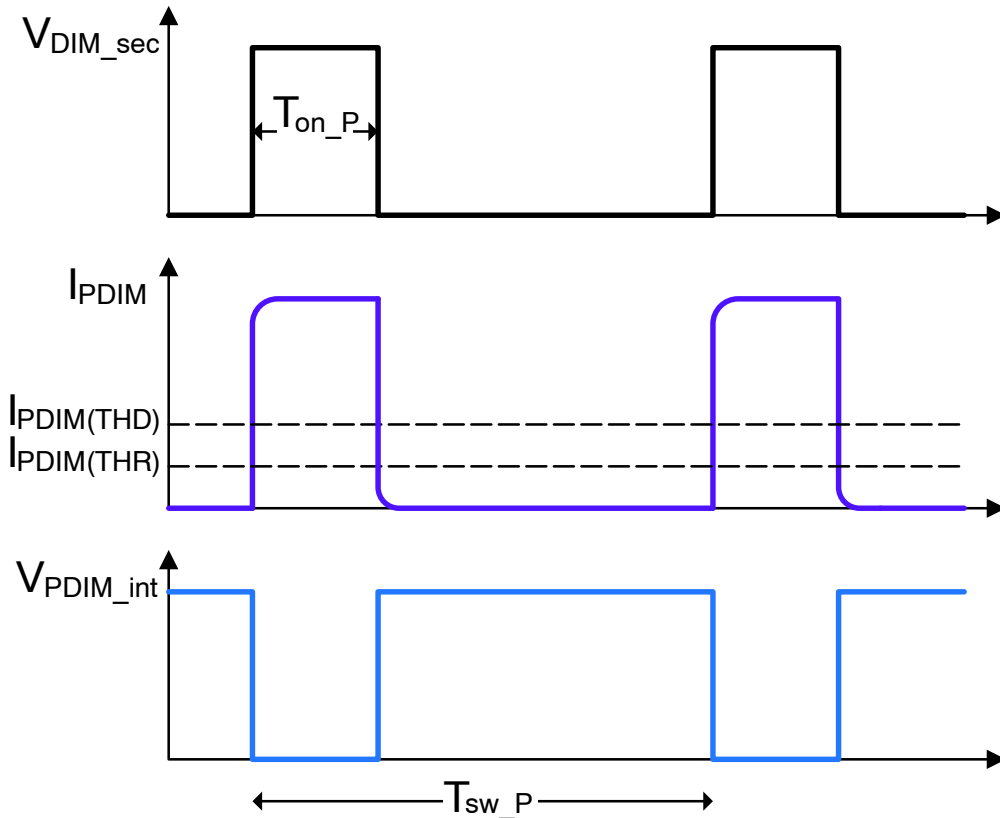

Figure 24. PDIM Internal Waveforms

Practically, the controller extracts the duty-cycle by measuring the current inside PDIM pin which is directly the opto coupler collector current.

If PDIM pin is left open, the controller delivers 100% of I_{out} . If the pin is pulled down for longer than 25 ms, the controller is disabled.

ANALOG DIMMING

The pin ADIM pin allows dimming the LED light using an analog signal as the control input.

The DIM pin voltage is sampled by an analog to digital converter and sets the output current value accordingly.

If the power supply designer applies an analog signal varying from $V_{DIM(EN)}$ to V_{DIM100} to the DIM pin, the output current will increase or decrease proportionally to the voltage applied. For $V_{DIM} = V_{DIM100}$, the power supply delivers the maximum output current ($V_{REFX} = V_{REF}$).

If a voltage lower than $V_{ADIM(MIN)}$ is applied to ADIM pin, the output current is clamped to 0.5% of the maximum output current depending on the controller option

If a voltage lower than $V_{ADIM(EN)}$ is applied to the DIM pin, the DRV pulses are disabled.

The DIM pin is pulled up internally by a small current source or resistor. Thus, if the pin is left open, the controller is able to start.

Note:

- Interaction between ADIM and PDIM: if ADIM and PDIM are both used at the same time, the resulting dimming set point is a multiplication of V_{ADIM} and the duty-ratio of PDIM signal.
- If the dimming curve option S is selected, a square relationship is implemented between the dimming signal and the output current setpoint.

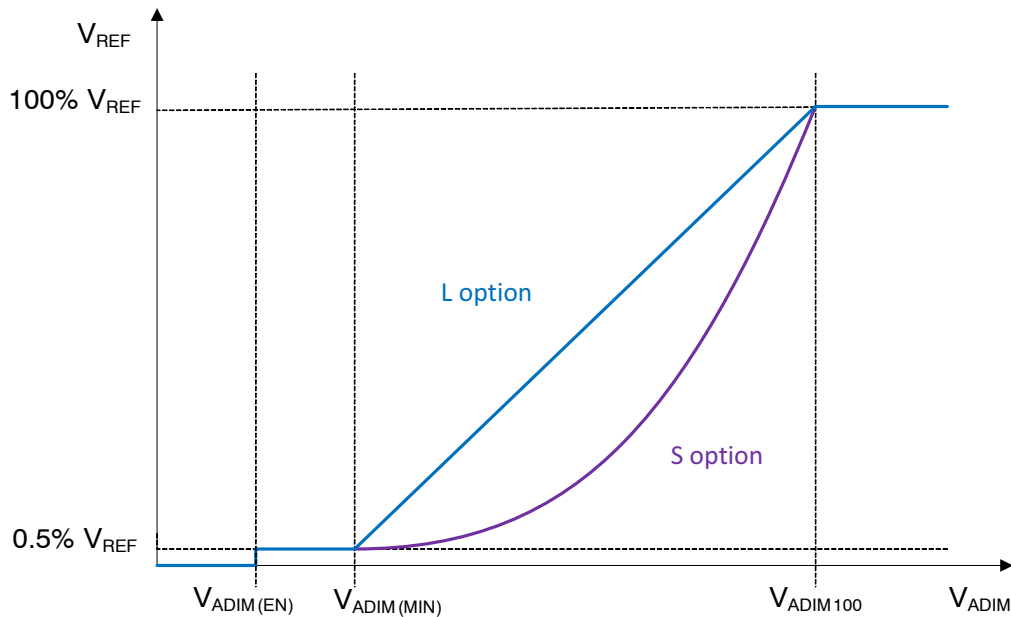

Figure 25. ADIM Pin Dimming Curves

VALLEY LOCKOUT

Quasi-Square wave resonant systems have a wide switching frequency excursion. The switching frequency increases when the output load decreases or when the input voltage increases. The switching frequency of such systems must be limited.

The NCL30386 changes valley as V_{REFX} decreases and as the input voltage increases and as the output current setpoint is varied during dimming. This limits the frequency excursion.

By default, when the output current is not dimmed, the controller operates in the first valley at low line and in the second valley at high line.



| V_{REFX} value at which the controller changes valley (I_{out} decreasing) | HV pin voltage for valley change | | V_{REFX} value at which the controller changes valley (I_{out} increasing) |
|---|---|-----------------|---|
| |  | | |
| | 0 --LL-- 230 V --HL-- 400 V | | |
| 100% | 1 st | 2 nd | 100% |
| 80% | 2 nd | 3 rd | 85% |
| 65% | 3 rd | 4 th | 70% |
| 50% | 4 th | 5 th | 55% |
| 35% | 5 th | 6 th | 40% |
| 25% | FF mode | FF mode | 30% |
| 0% | FF mode | FF mode | 0% |
| |  | | |
| | 0 --LL-- 240 V --HL-- 400 V | | |
| | HV pin voltage for valley change | | |

Figure 26. TABLE II: Valley Selection

ZERO CROSSING DETECTION BLOCK

The ZCD pin allows detecting when the drain–source voltage of the power MOSFET reaches a valley.

A valley is detected when the ZCD pin voltage crosses below the 55 mV internal threshold.

At startup or in case of extremely damped free oscillations, the ZCD comparator may not be able to detect

the valleys. To avoid such a situation, the NCL30386 a Time–Out circuit that generates pulses if the voltage on ZCD pin stays below the 55 mV threshold for 6.5 μ s.

The Time–out also acts as a substitute clock for the valley detection and simulates a missing valley in case of too damped free oscillations.

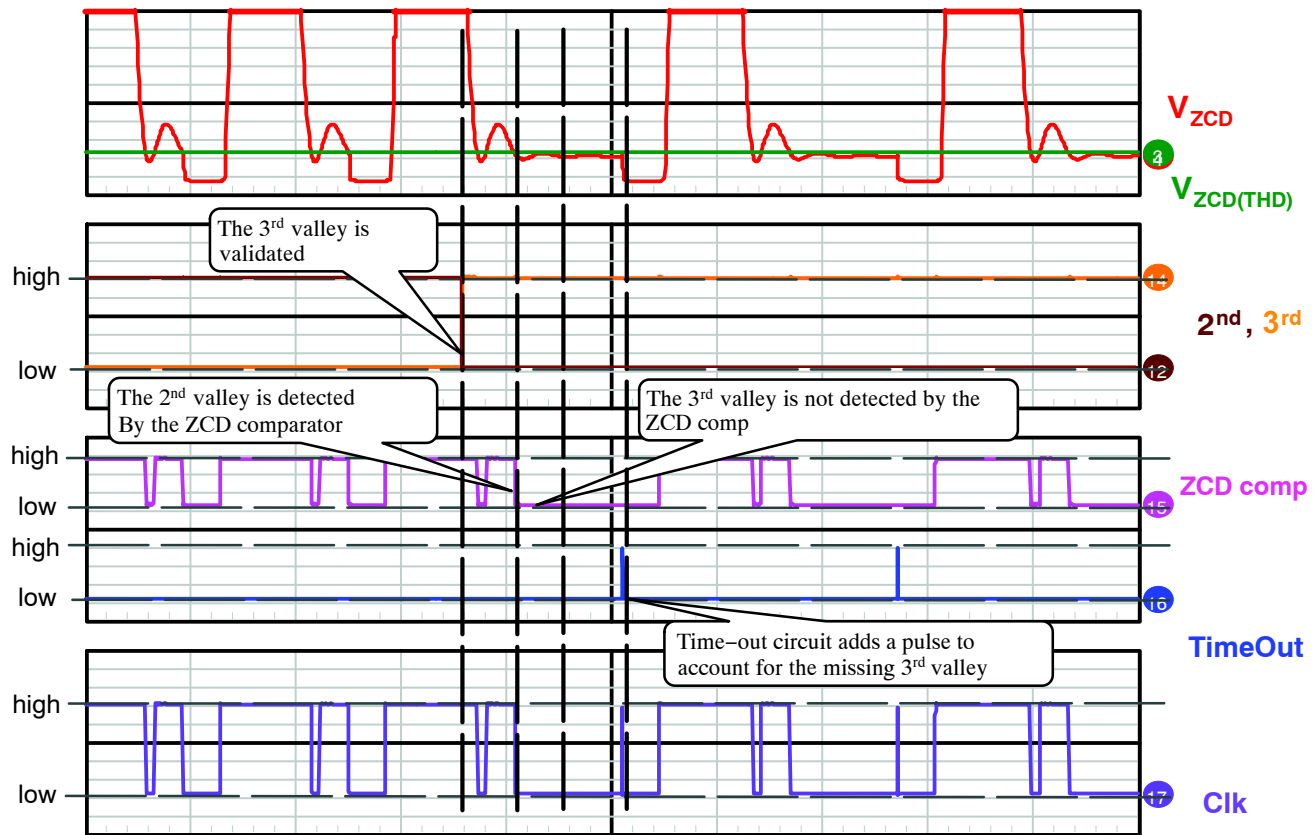

Figure 27. ZCD Time–out Chronograms

If the ZCD pin or the auxiliary winding happen to be shorted the time–out function would normally make the controller keep switching and hence lead to improper regulation of the LED current.

The Under Voltage Protection (UVP) is implemented to avoid these scenarios: a secondary timer starts counting when the ZCD voltage is below the $V_{ZCD(short)}$ threshold. If this timer reaches 90 ms, the controller detects a fault and enters the auto–recovery fault mode.

ZCD PIN OVER VOLTAGE PROTECTION.

Because of the power factor correction, it is necessary to set the crossover frequency of the CV loop very low (target 10 Hz, depending on power stage phase shift). Because the loop is slow, the output voltage can reach high value during startup or during an output load step. It is necessary to limit the output voltage excursion. For this, the NCL30388

features a slow over voltage protection (slow OVP) and a fast over voltage protection (fast OVP) on ZCD pin.

Slow OVP

If ZCD voltage exceed $V_{ZCD(OVP1)}$ for 4 consecutive switching cycles, the controller stops switching during 1.4 ms. After 1.4 ms, the controller initiates a new DRV pulse to refresh ZCD sampling voltage. If V_{ZCD} is still too high ($V_{ZCD} > 110\%V_{REF(CV)}$), the controller continues to switch with a 1.4 ms period. The controller resumes its normal operation when $V_{ZCD} < 110\%V_{REF(CV)}$.

Fast OVP

If ZCD voltage exceeds $V_{ZCD(OVP2)}$ (130% of $V_{REF(CV)}$) for 4 consecutive switching cycles (slow OVP not triggered) or for 2 switching cycles if the slow OVP has already been triggered, the controller detects a fault and starts the auto–recovery fault mode (cf: Protections Section)

LINE FEEDFORWARD

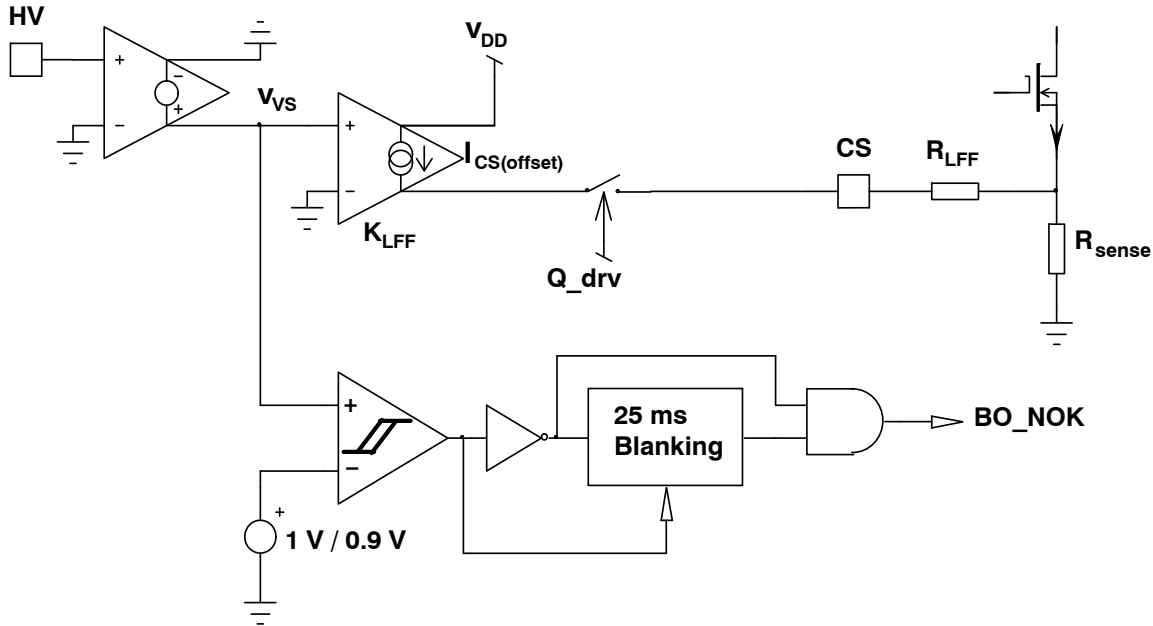

Figure 28. Line Feed-Forward and Brown-out Schematic

The line voltage is sensed by the HV pin and converted into a current. By adding an external resistor in series between the sense resistor and the CS pin, a voltage offset proportional to the line voltage is added to the CS signal. The offset is applied only during the MOSFET on-time in order to not influence the detection of the leakage inductance reset.

The offset is always applied even at light load in order to improve the current regulation at low output load.

BROWN-OUT

In order to protect the supply against a very low input voltage, the NCL30386 features a brown-out circuit with a fixed ON/OFF threshold. The controller is allowed to start if a voltage higher than 100 V is applied to the HV pin and shuts-down if the HV pin voltage decreases and stays below 9.0 V for 25 ms typical. Exiting a brown-out condition overrides the hiccup on VCC (VCC does not wait to reach VCC(off)) and the IC immediately goes into startup mode.

PROTECTIONS

The circuit incorporates a large variety of protections to make the LED driver very rugged.

Among them, we can list:

- Fault of the GND connection
If the GND pin is properly connected, the supply current drawn from the positive terminal of the VCC capacitor, flows out of the GND pin to return to the negative terminal of the VCC capacitor. If the GND pin is not connected, the circuit ESD diodes offer another return path. The accidental non connection of the GND pin can hence be detected by detecting that one of this ESD diode is conducting. Practically, the ESD diode of

- CS pin is monitored. If such a fault is detected for 200 μs, the circuit stops generating DRV pin.
- Output short circuit situation (Output Under Voltage Protection)
Overload is detected by monitoring the ZCD pin voltage: if it remains below VZCD(short) for 90 ms, an output short circuit is detected and the circuit stops generating pulses for 4 s. When this 4 s delay has elapsed, the circuit attempts to restart.
- ZCD pin incorrect connection:
 - ♦ If the ZCD pin grounded, the circuit will detect an output short circuit situation when 90-ms delay has elapsed.
 - ♦ A 200 kΩ resistor pulls down the ZCD pin so that the output short circuit detection trips if the ZCD pin is not connected (floating).
- Winding or Output Diode Short Circuit protection
The circuit detects this failure when 4 consecutive DRV pulses occur within which the CS pin voltage exceeds (VCS(stop)=140% * VILIM). In this case, the controller enters auto-recovery mode (4-s operation interruption between active bursts).
- VCC Over Voltage Protection
The circuit stops generating pulses if the VCC exceeds VCC(OVP) and enters auto-recovery mode. This feature protects the circuit if output LEDs happen to be disconnected.
- ZCD fast OVP
If ZCD voltage exceeds VZCD(OVP2) for 4 consecutive switching cycles (slow OVP not triggered) or for 2 switching cycles if the slow OVP has already been

NCL30386

triggered, the controller detects a fault and enters auto-recovery mode (4 s operation interruption between active bursts).

- **Die Over Temperature (TSD)**
The circuit stops operating if the junction temperature (T_J) exceeds 150°C typically. The controller remains off until T_J goes below nearly 100°C.
- **Brown-Out Protection (BO)**
The circuit prevents operation when the line voltage is too low to avoid an excessive stress of the LED driver. Operation resumes as soon as the line voltage is high enough and V_{CC} is higher than $V_{CC(on)}$.
- **CS pin short to ground**
The CS pin is checked at start-up (cold start-up or after

a brown-out event). A current source ($I_{CS(short)}$) is applied to the pin and no DRV pulse is generated until the CS pin exceeds $V_{CS(low)}$. $I_{CS(short)}$ and $V_{CS(low)}$ are 500 μ A and 60 mV typically (V_{CS} rising). The typical minimum impedance to be placed on the CS pin for operation is then 120 Ω . In practice, it is recommended to place more than 250 Ω to take into account possible parametric deviations

Also, along the circuit operation, the CS pin could happen to be grounded. If it is grounded, the MOSFET conduction time is limited by the maximum on-time. If such an event occurs, a new pin impedance test is made.

ORDERING TABLE OPTION

| OPN # | DSS | | Maximum dead-time | | | V_{REF} | | Max. On-time | | ZCD blanking | | Dimming Curve | | Line Range Detector | | Dimming Clamp | | |
|------------|-----|-----|-------------------|-------------|--------|-----------|--------|--------------|------------|--------------|-------------|---------------|--------|---------------------|-----|---------------|-----|---|
| | Y | N | A | B | C | U | V | A | B | A | B | L | S | Y | N | Y | N | |
| | On | Off | 250 μ s | 687 μ s | 1.4 ms | 250 mV | 333 mV | 20 μ s | 33 μ s | 1 μ s | 1.5 μ s | Linear | Square | On | Off | On | Off | |
| NCL30386A1 | x | | | x | | | x | x | | | x | x | | | x | x | | |
| NCL30386B1 | x | | | x | | | x | x | | x | | x | | | x | | | x |

ORDERING INFORMATION2

| Device | Marking | Package type | Shipping† |
|----------------|----------|-------------------------|--------------------|
| NCL30386A1DR2G | L30386A1 | SOIC9 COMP EPX 0.5P PBF | 2500 / Tape & Reel |
| NCL30386B1DR2G | L30386B1 | SOIC9 COMP EPX 0.5P PBF | 2500 / Tape & Reel |

†For information on tape and reel specifications, including part orientation and tape sizes, please refer to our Tape and Reel Packaging Specifications Brochure, BRD8011/D.

MECHANICAL CASE OUTLINE

PACKAGE DIMENSIONS

ON Semiconductor®



SOIC-9 NB
CASE 751BP
ISSUE A

DATE 21 NOV 2011



SCALE 1:1

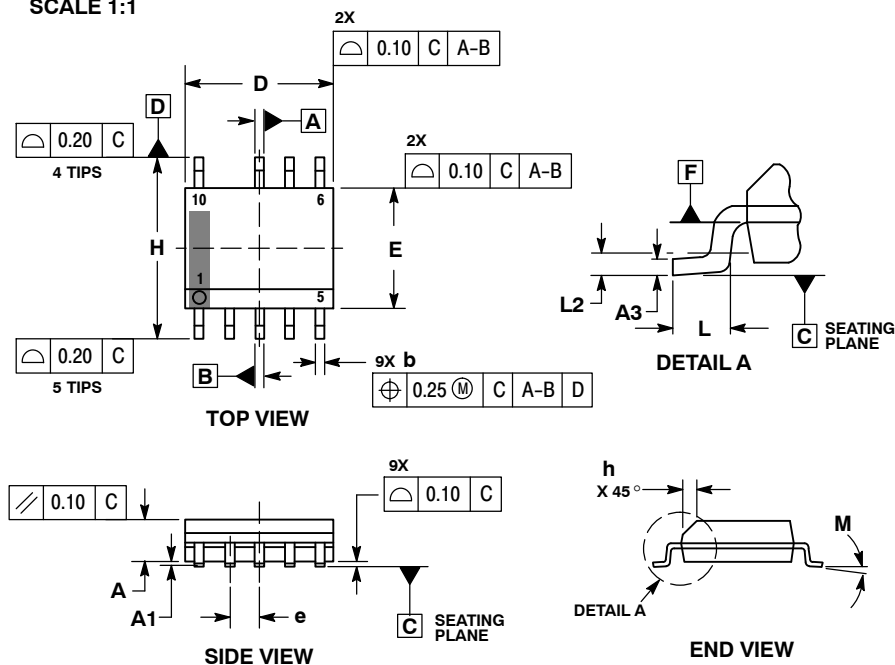

- NOTES:
1. DIMENSIONING AND TOLERANCING PER ASME Y14.5M, 1994.
 2. CONTROLLING DIMENSION: MILLIMETERS.
 3. DIMENSION b DOES NOT INCLUDE DAMBAR PROTRUSION. ALLOWABLE PROTRUSION SHALL BE 0.10mm TOTAL IN EXCESS OF 'b' AT MAXIMUM MATERIAL CONDITION.
 4. DIMENSIONS D AND E DO NOT INCLUDE MOLD FLASH, PROTRUSIONS, OR GATE BURRS. MOLD FLASH, PROTRUSIONS, OR GATE BURRS SHALL NOT EXCEED 0.15mm PER SIDE. DIMENSIONS D AND E ARE DETERMINED AT DATUM F.
 5. DIMENSIONS A AND B ARE TO BE DETERMINED AT DATUM F.
 6. A1 IS DEFINED AS THE VERTICAL DISTANCE FROM THE SEATING PLANE TO THE LOWEST POINT ON THE PACKAGE BODY.

| MILLIMETERS | | |
|-------------|----------|------|
| DIM | MIN | MAX |
| A | 1.25 | 1.75 |
| A1 | 0.10 | 0.25 |
| A3 | 0.17 | 0.25 |
| b | 0.31 | 0.51 |
| D | 4.80 | 5.00 |
| E | 3.80 | 4.00 |
| e | 1.00 BSC | |
| H | 5.80 | 6.20 |
| h | 0.37 REF | |
| L | 0.40 | 1.27 |
| L2 | 0.25 BSC | |
| M | 0° | 8° |

GENERIC MARKING DIAGRAM*

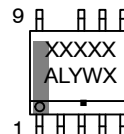

- XXXXX = Specific Device Code
- A = Assembly Location
- L = Wafer Lot
- Y = Year
- W = Work Week
- = Pb-Free Package

*This information is generic. Please refer to device data sheet for actual part marking. Pb-Free indicator, "G", may or not be present.

RECOMMENDED SOLDERING FOOTPRINT*

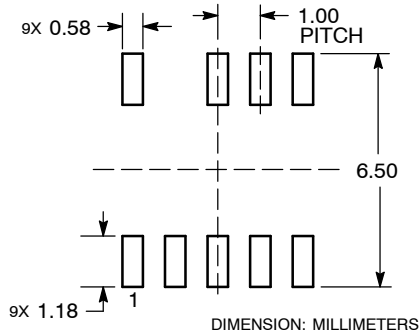

*For additional information on our Pb-Free strategy and soldering details, please download the ON Semiconductor Soldering and Mounting Techniques Reference Manual, SOLDETRM/D.

| | | |
|------------------|---------------------------|--|
| DOCUMENT NUMBER: | 98AON52301E | Electronic versions are uncontrolled except when accessed directly from the Document Repository. Printed versions are uncontrolled except when stamped "CONTROLLED COPY" in red. |
| STATUS: | ON SEMICONDUCTOR STANDARD | |
| NEW STANDARD: | | |
| DESCRIPTION: | SOIC-9 NB | PAGE 1 OF 2 |



| ISSUE | REVISION | DATE |
|-------|--|-------------|
| O | RELEASED FOR PRODUCTION. REQ. BY M. RAMOS. | 06 JUL 2010 |
| A | CHANGED DIMENSION A MINIMUM FROM 1.35 TO 1.25. REQ. BY I. CAMBALIZA. | 21 NOV 2011 |
| | | |
| | | |
| | | |
| | | |
| | | |
| | | |
| | | |
| | | |
| | | |
| | | |
| | | |
| | | |
| | | |
| | | |
| | | |
| | | |
| | | |
| | | |
| | | |
| | | |
| | | |
| | | |
| | | |
| | | |
| | | |
| | | |
| | | |
| | | |
| | | |
| | | |
| | | |
| | | |

ON Semiconductor and ON are registered trademarks of Semiconductor Components Industries, LLC (SCILLC). SCILLC reserves the right to make changes without further notice to any products herein. SCILLC makes no warranty, representation or guarantee regarding the suitability of its products for any particular purpose, nor does SCILLC assume any liability arising out of the application or use of any product or circuit, and specifically disclaims any and all liability, including without limitation special, consequential or incidental damages. "Typical" parameters which may be provided in SCILLC data sheets and/or specifications can and do vary in different applications and actual performance may vary over time. All operating parameters, including "Typicals" must be validated for each customer application by customer's technical experts. SCILLC does not convey any license under its patent rights nor the rights of others. SCILLC products are not designed, intended, or authorized for use as components in systems intended for surgical implant into the body, or other applications intended to support or sustain life, or for any other application in which the failure of the SCILLC product could create a situation where personal injury or death may occur. Should Buyer purchase or use SCILLC products for any such unintended or unauthorized application, Buyer shall indemnify and hold SCILLC and its officers, employees, subsidiaries, affiliates, and distributors harmless against all claims, costs, damages, and expenses, and reasonable attorney fees arising out of, directly or indirectly, any claim of personal injury or death associated with such unintended or unauthorized use, even if such claim alleges that SCILLC was negligent regarding the design or manufacture of the part. SCILLC is an Equal Opportunity/Affirmative Action Employer. This literature is subject to all applicable copyright laws and is not for resale in any manner.

ON Semiconductor and  are trademarks of Semiconductor Components Industries, LLC dba ON Semiconductor or its subsidiaries in the United States and/or other countries. ON Semiconductor owns the rights to a number of patents, trademarks, copyrights, trade secrets, and other intellectual property. A listing of ON Semiconductor's product/patent coverage may be accessed at www.onsemi.com/site/pdf/Patent-Marking.pdf. ON Semiconductor reserves the right to make changes without further notice to any products herein. ON Semiconductor makes no warranty, representation or guarantee regarding the suitability of its products for any particular purpose, nor does ON Semiconductor assume any liability arising out of the application or use of any product or circuit, and specifically disclaims any and all liability, including without limitation special, consequential or incidental damages. Buyer is responsible for its products and applications using ON Semiconductor products, including compliance with all laws, regulations and safety requirements or standards, regardless of any support or applications information provided by ON Semiconductor. "Typical" parameters which may be provided in ON Semiconductor data sheets and/or specifications can and do vary in different applications and actual performance may vary over time. All operating parameters, including "Typicals" must be validated for each customer application by customer's technical experts. ON Semiconductor does not convey any license under its patent rights nor the rights of others. ON Semiconductor products are not designed, intended, or authorized for use as a critical component in life support systems or any FDA Class 3 medical devices or medical devices with a same or similar classification in a foreign jurisdiction or any devices intended for implantation in the human body. Should Buyer purchase or use ON Semiconductor products for any such unintended or unauthorized application, Buyer shall indemnify and hold ON Semiconductor and its officers, employees, subsidiaries, affiliates, and distributors harmless against all claims, costs, damages, and expenses, and reasonable attorney fees arising out of, directly or indirectly, any claim of personal injury or death associated with such unintended or unauthorized use, even if such claim alleges that ON Semiconductor was negligent regarding the design or manufacture of the part. ON Semiconductor is an Equal Opportunity/Affirmative Action Employer. This literature is subject to all applicable copyright laws and is not for resale in any manner.

PUBLICATION ORDERING INFORMATION

LITERATURE FULFILLMENT:

Literature Distribution Center for ON Semiconductor
19521 E. 32nd Pkwy, Aurora, Colorado 80011 USA
Phone: 303-675-2175 or 800-344-3860 Toll Free USA/Canada
Fax: 303-675-2176 or 800-344-3867 Toll Free USA/Canada
Email: orderlit@onsemi.com

N. American Technical Support: 800-282-9855 Toll Free
USA/Canada
Europe, Middle East and Africa Technical Support:
Phone: 421 33 790 2910

ON Semiconductor Website: www.onsemi.com

Order Literature: <http://www.onsemi.com/orderlit>

For additional information, please contact your local
Sales Representative