

Product Description

Qorvo's QPA2237 is a wideband amplifier fabricated on Qorvo's production 0.25um GaN on SiC process. The QPA2237 operates from 0.03 – 2.5 GHz and provides 10W of saturated output power with 13 dB of large signal gain and 52% power-added efficiency.

The QPA2237 is available in a low-cost, surface-mount, 20 lead, 4x4 OVM QFN. It is ideally suited to support both radar and communication applications across defense and commercial markets as well as electronic warfare. The QPA2237 is fully matched to 50Ω at both RF ports allowing for simple system integration. DC blocks are required on both RF ports and the drain voltage must be injected through an off chip bias-tee on the RF output port.

Lead-free and RoHS compliant.

Functional Block Diagram

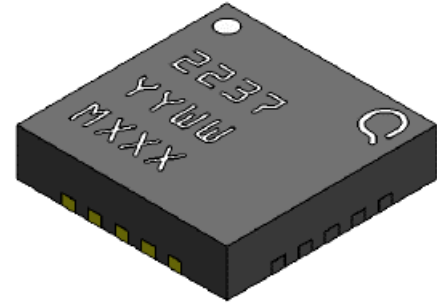
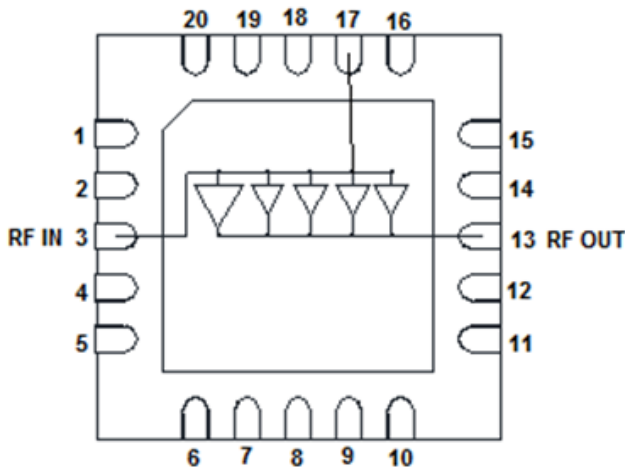

QFN 4x4 mm 20L

Product Features

- Frequency Range: 0.03 – 2.5 GHz
- P_{SAT}: 40 dBm at P_{IN} = 27 dBm
- PAE: 52%
- Large Signal Gain: 13 dB
- Small Signal Gain: 18.5 dB
- Input Return Loss: 9 dB
- Output Return Loss: 9.5 dB
- Bias: V_D = 32 V, I_{DQ} = 360 mA
- Wideband Flat Power
- Package Dimensions: 4.0 x 4.0 x 0.85 mm

Performance is typical across frequency. Please reference electrical specification table and data plots for more details.

Applications

- Commercial and military radar
- Communications
- Electronic Warfare

Ordering Information

Part No.	Description
QPA2237	0.03–2.5 GHz 10W GaN Power Amplifier
QPA2237EVBP01	Evaluation Board

Electrical Specifications

Test conditions unless otherwise noted: 25 °C, $V_D = +32\text{ V}$, $I_{DQ} = 360\text{ mA}$, CW.

Parameter		Min	Typ	Max	Units
Operational Frequency Range		0.03	–	2.5	GHz
Output Power @ $P_{IN} = 27\text{ dBm}$	Frequency = 0.05 GHz	39.5	40.5	–	dBm
	Frequency = 1.25 GHz	39.5	40.1	–	
	Frequency = 2.5 GHz	39.5	40.4	–	
Power Added Efficiency @ $P_{IN} = 27\text{ dBm}$	Frequency = 0.05 GHz	48	65	–	%
	Frequency = 1.25 GHz	48	48.5	–	
	Frequency = 2.5 GHz	48	57	–	
Small Signal Gain	Frequency = 0.05 GHz	–	22.5	–	dB
	Frequency = 1.25 GHz	–	20	–	
	Frequency = 2.5 GHz	–	19	–	
Input Return Loss	Frequency = 0.05 GHz	–	9	–	dB
	Frequency = 1.25 GHz	–	13	–	
	Frequency = 2.5 GHz	–	13	–	
Output Return Loss	Frequency = 0.05 GHz	–	10	–	dB
	Frequency = 1.25 GHz	–	11	–	
	Frequency = 2.5 GHz	–	16	–	
Gate Leakage ($V_D=30\text{V}$, $V_G=-5.0\text{V}$)		-2.4	-0.4	-0.0001	mA
Small Signal Gain Temperature Coefficient		–	-0.017	–	dB/°C
Output Power Temperature Coefficient		–	-0.004	–	dBm/°C
Recommended Operating Voltage:		–	32	36	V

Recommended Operating Conditions

Parameter	Value / Range
Drain Voltage (V_D)	+32 V
Drain Current (I_{DQ})	360 mA
Gate Voltage (V_G)	-2.8 to -2.0 V
Temperature (T_{BASE})	-40 to 85 °C

Electrical specifications are measured at specified test conditions. Specifications are not guaranteed over all recommended operating conditions.

Performance Plots – Large Signal (CW)

The plots reflect performance measured with an external coaxial bias tee and DC blocks
(See application circuit on page 11)

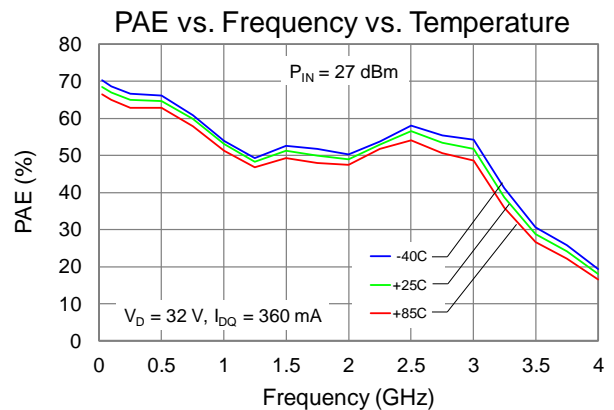
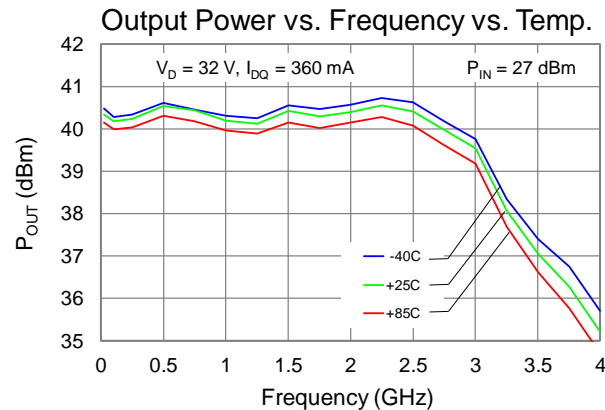
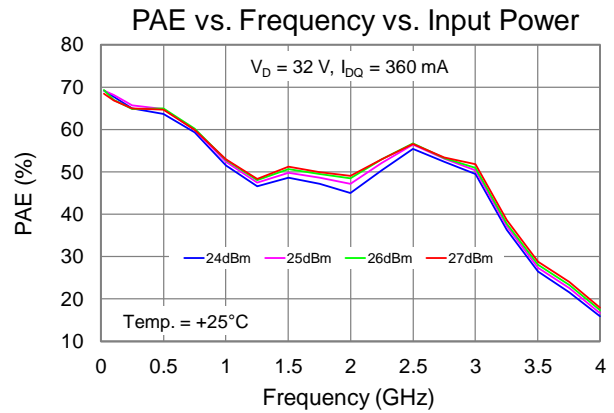
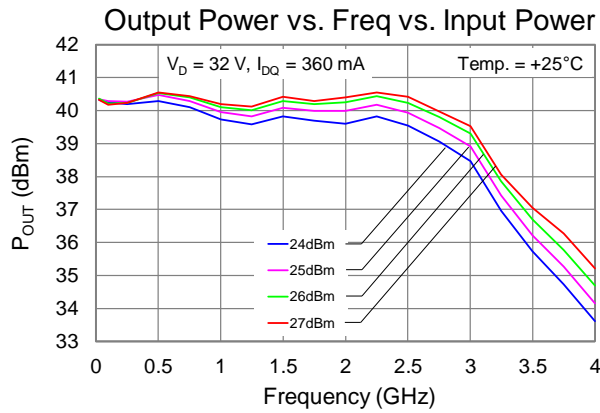
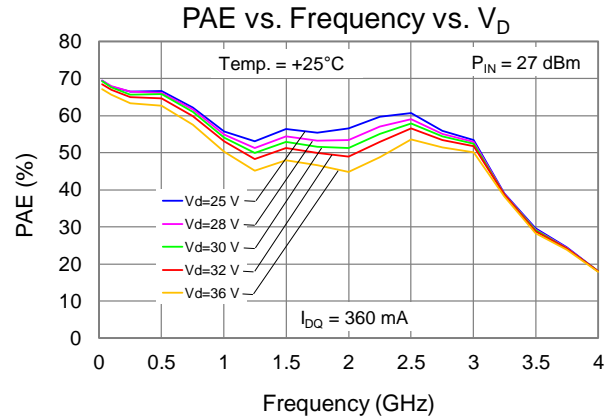
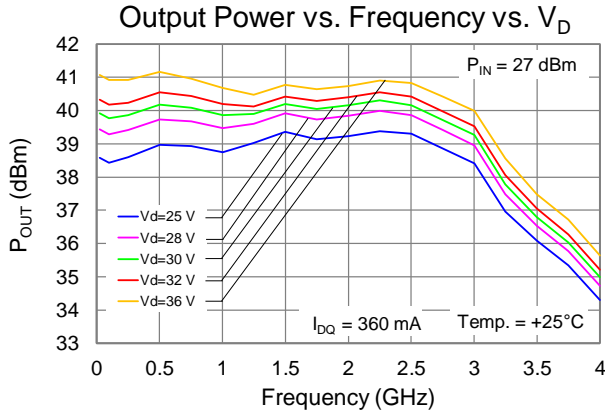

Performance Plots – Large Signal (CW)

The plots reflect performance measured with an external coaxial bias tee and DC blocks
(See application circuit on page 11)

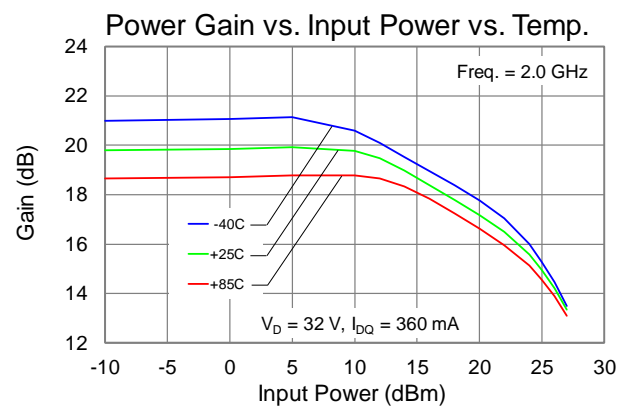
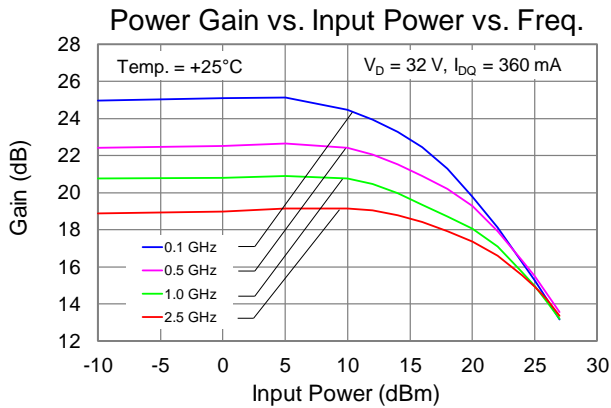
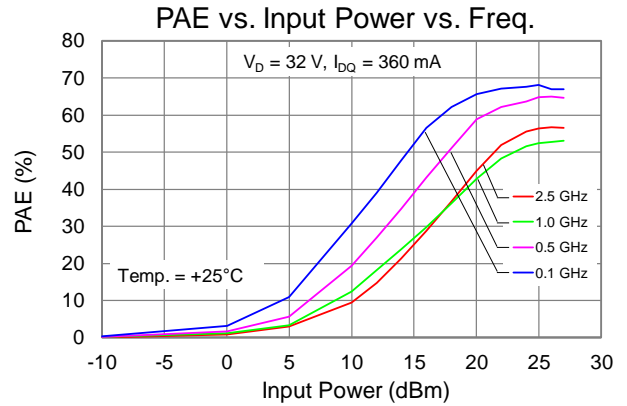
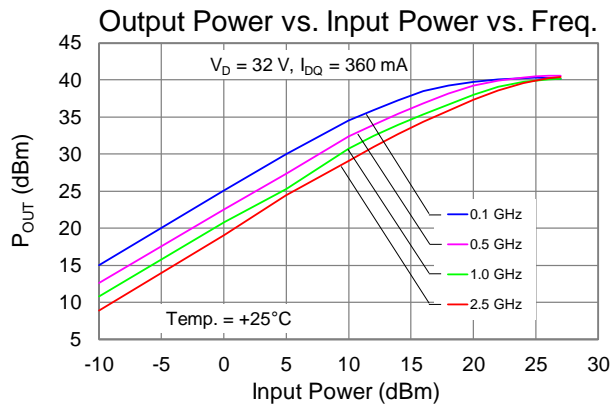
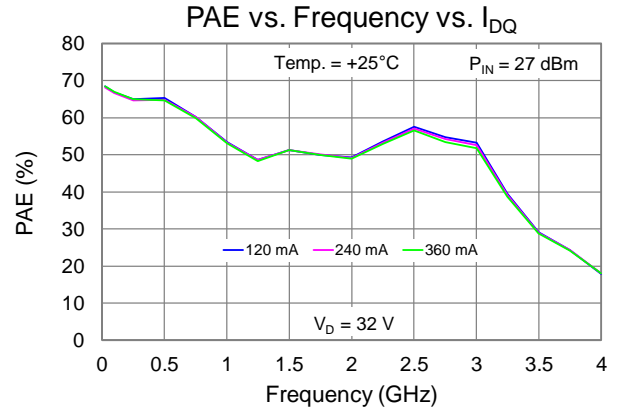
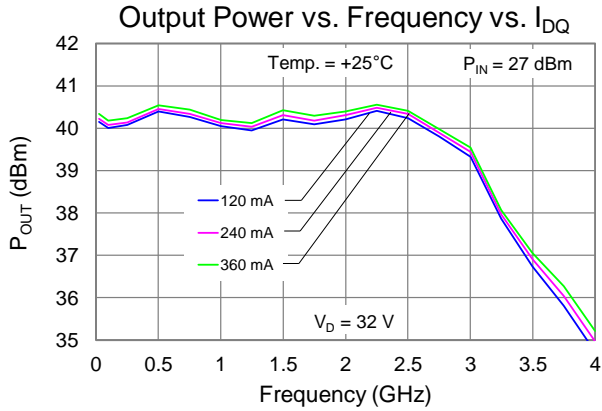

Performance Plots – Large Signal (CW)

The plots reflect performance measured with an external coaxial bias tee and DC blocks
(See application circuit on page 11)

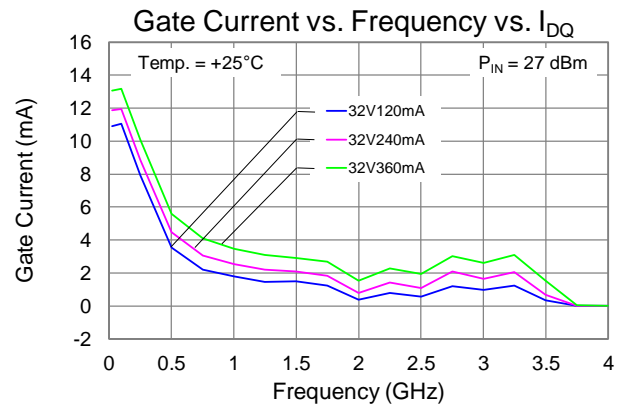
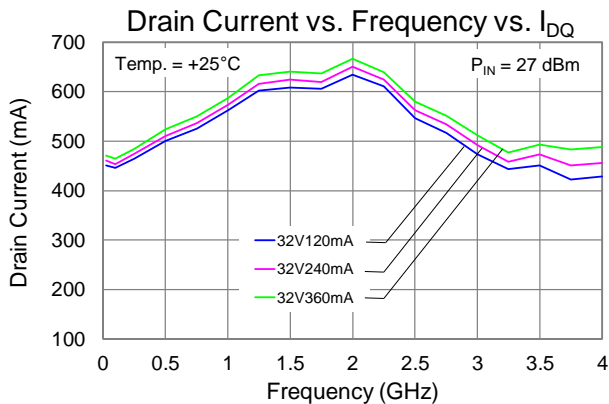
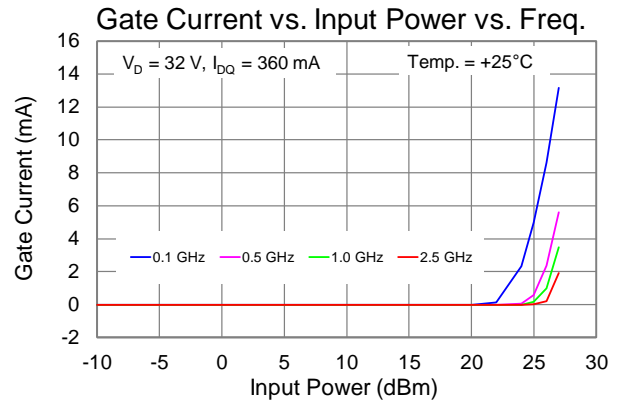
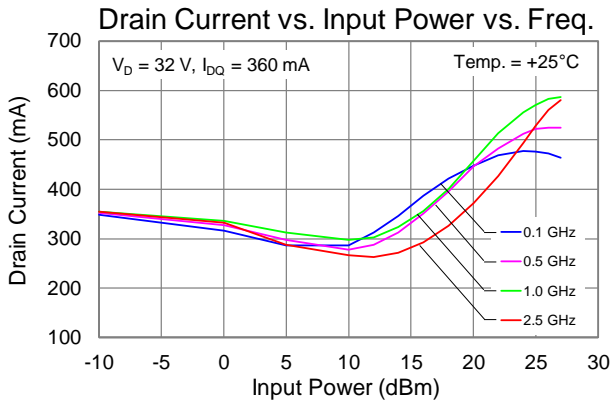
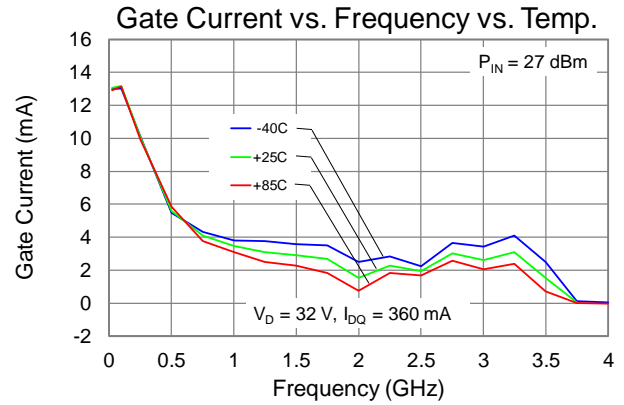
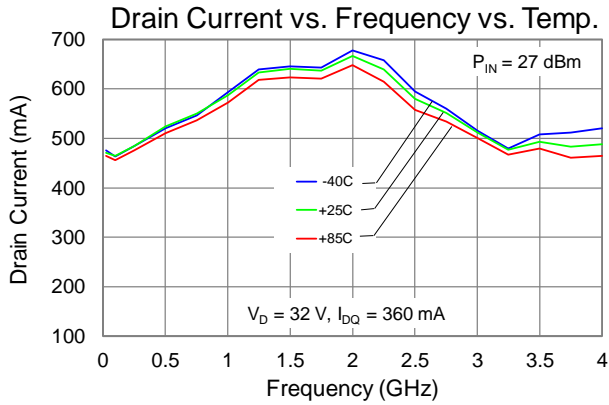

Performance Plots – Linearity

The plots reflect performance measured with an external coaxial bias tee and DC blocks
(See application circuit on page 11)

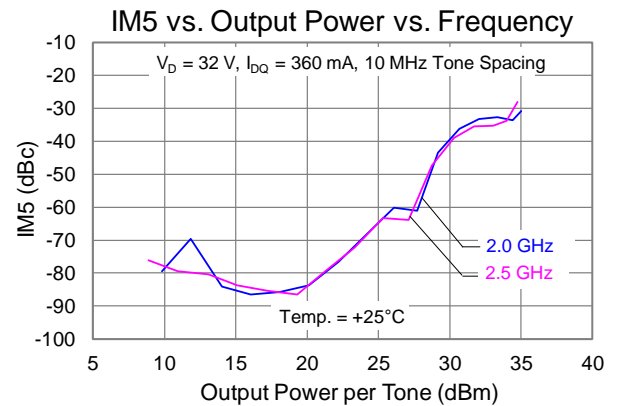
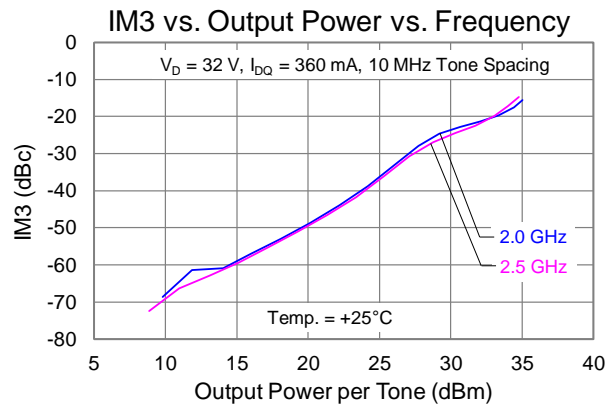
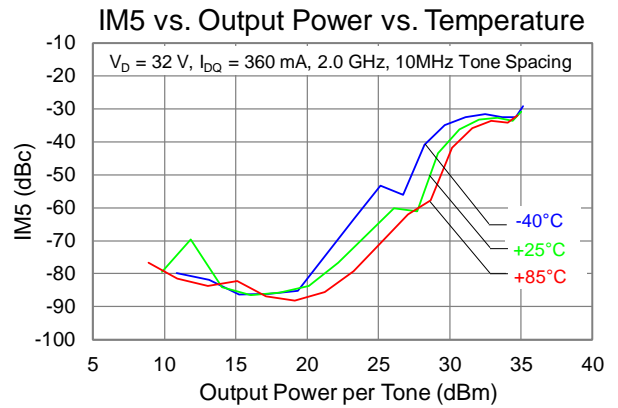
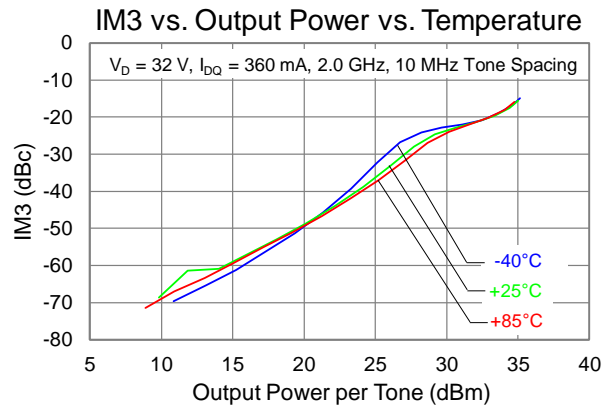
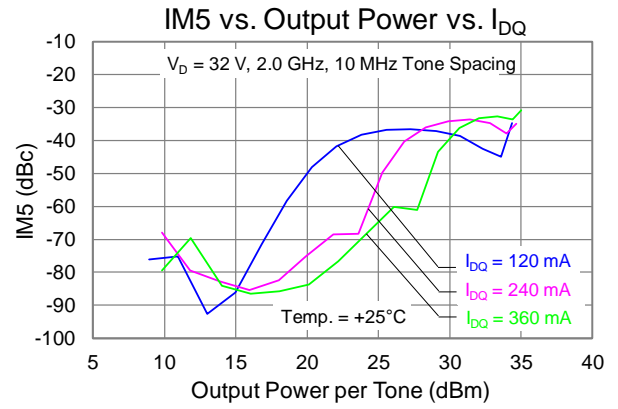
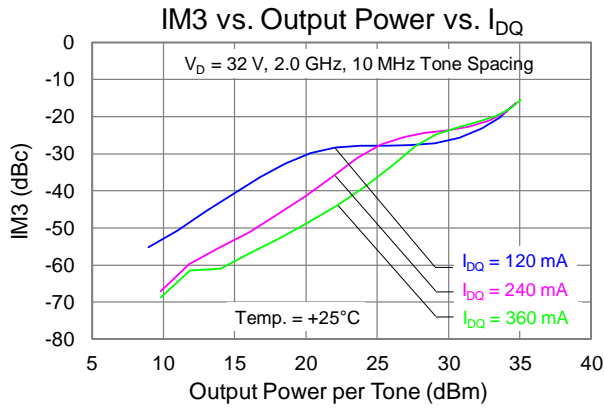

Performance Plots – Linearity

The plots reflect performance measured with an external coaxial bias tee and DC blocks
(See application circuit on page 11)

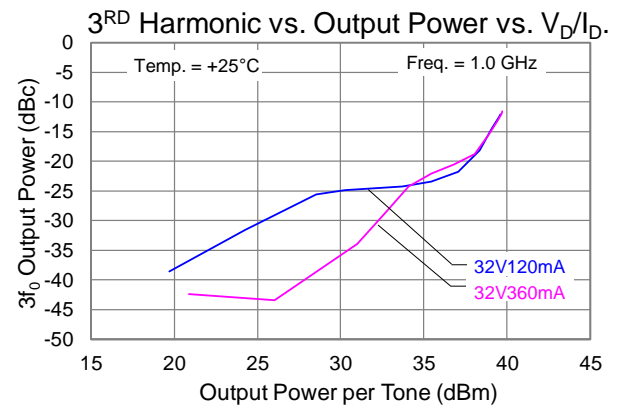
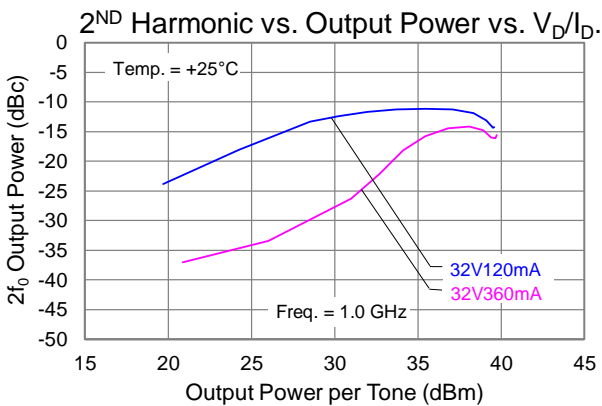
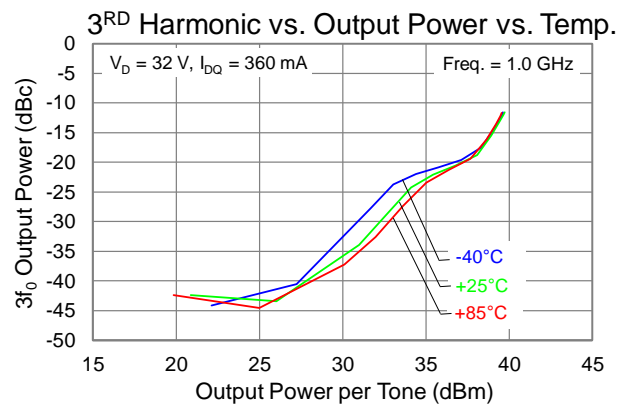
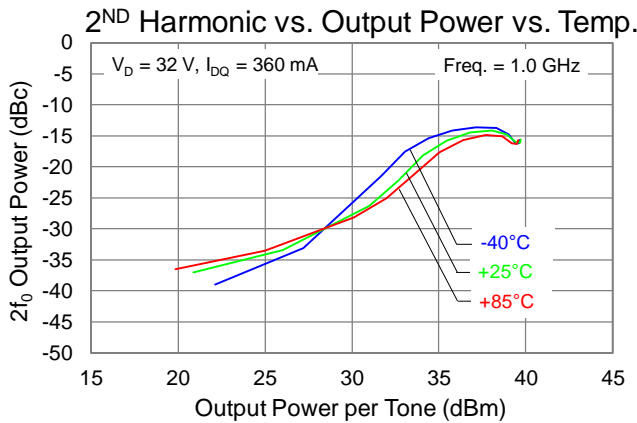
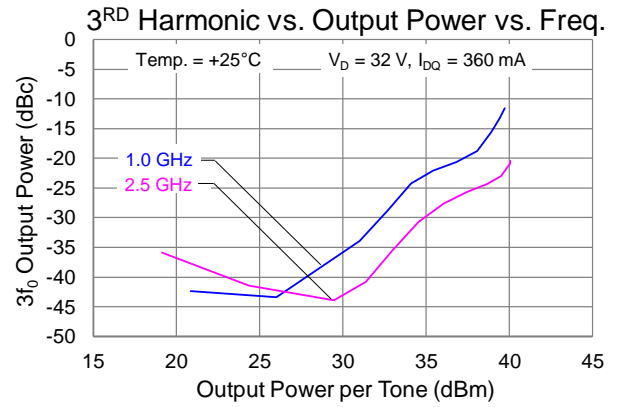
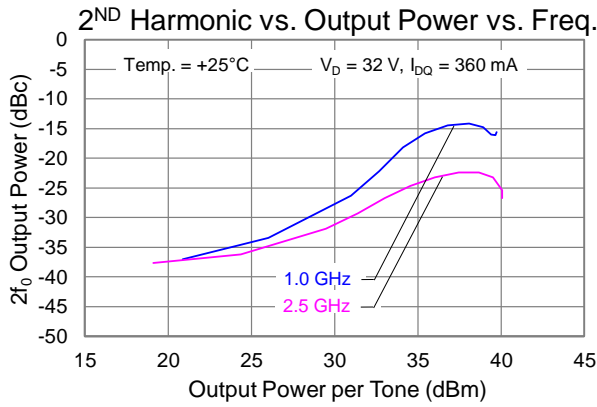

Performance Plots – Small Signal

The plots reflect performance measured with an external coaxial bias tee and DC blocks
(See application circuit on page 11)

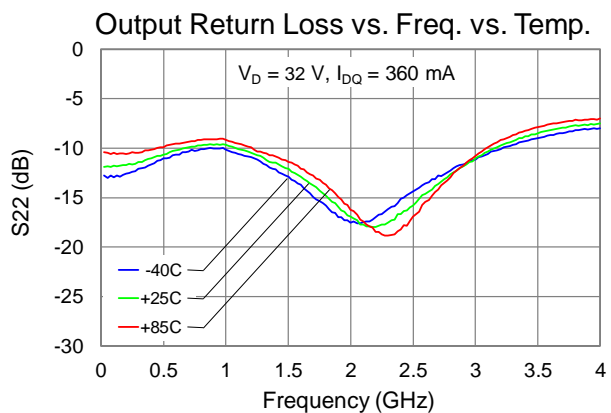
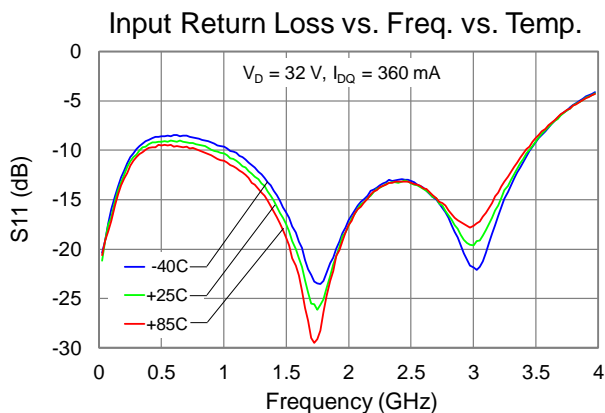
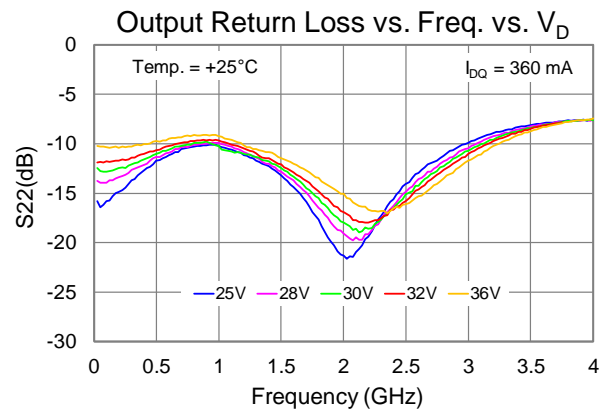
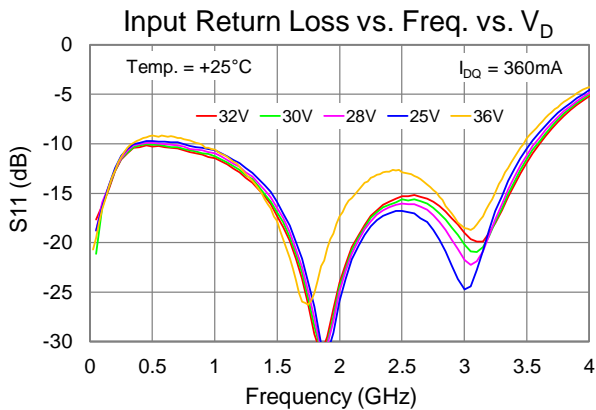
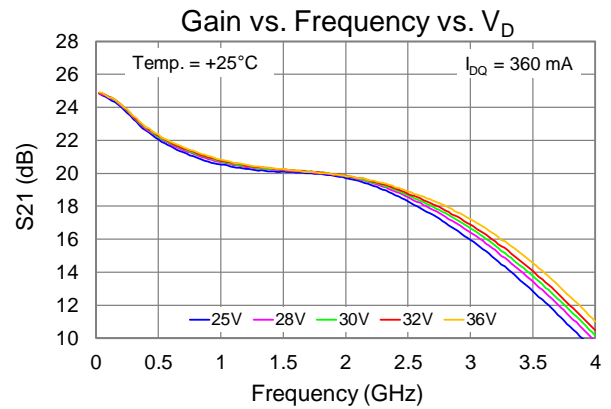
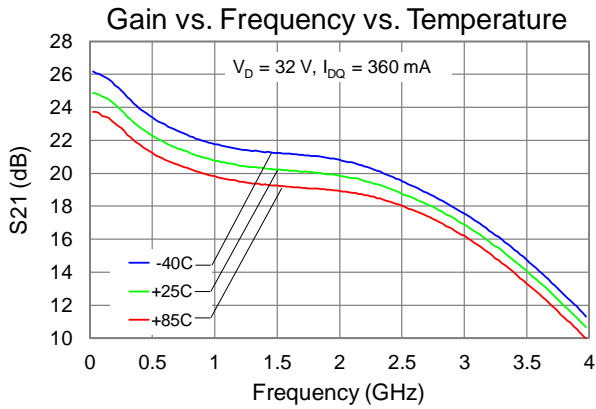

Performance Plots – Large Signal (CW), On-board vs. External Coaxial Bias-T

The plots reflect performance measured with an external coaxial bias tee and DC blocks
(See application circuit on page 11 and 13)

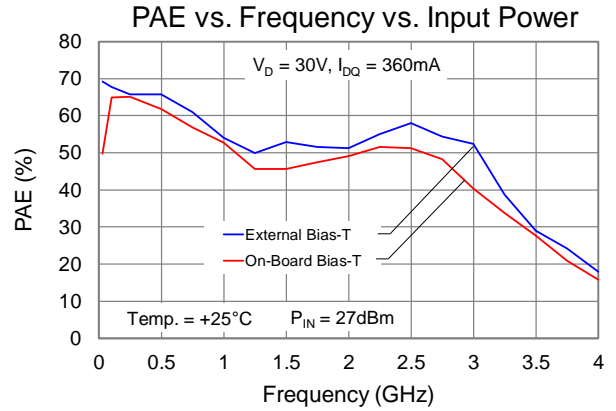
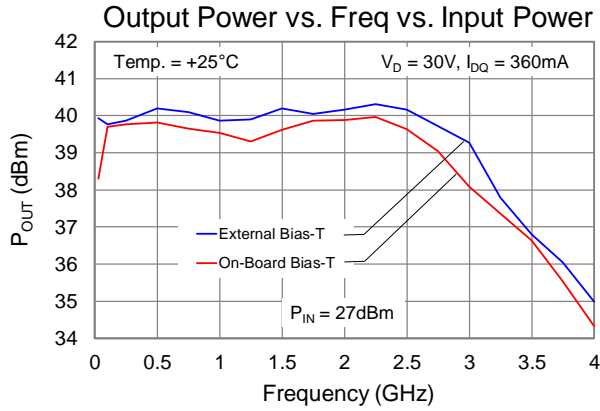

Thermal and Reliability Information

Parameter	Test Conditions	Value	Units
Thermal Resistance (θ_{JC}) ⁽¹⁾	$T_{BASE} = 85\text{ }^{\circ}\text{C}$, $V_D = +32\text{ V}$ (CW), Freq = 2.0 GHz	5.438	$^{\circ}\text{C/W}$
Channel Temperature (T_{CH}) (Under RF drive) ⁽²⁾	$P_{IN} = 27\text{ dBm}$, $I_{DQ} = 360\text{ mA}$, $I_{D_Drive} = 648\text{ mA}$, $P_{OUT} = 40\text{ dBm}$, $P_{DISS} = 10.9\text{ W}$	144.3	$^{\circ}\text{C}$

Notes:

1. Thermal resistance referenced to back of package.
2. IR scan equivalent. Refer to the following document: [GaN Device Channel Temperature, Thermal Resistance, and Reliability Estimates](#)

Power Dissipation and Maximum Gate Current

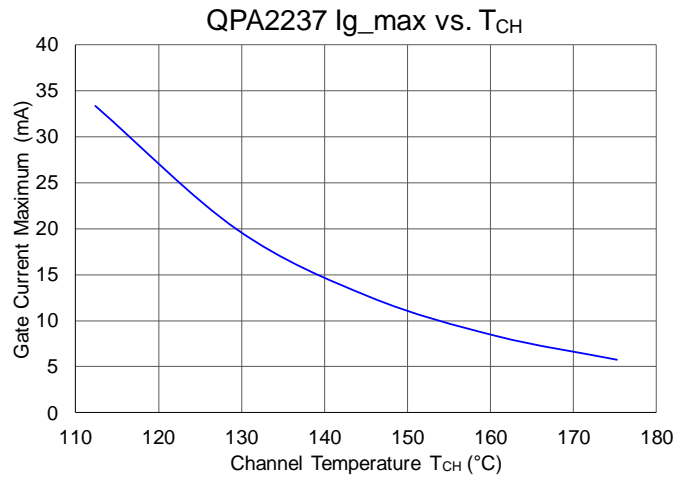
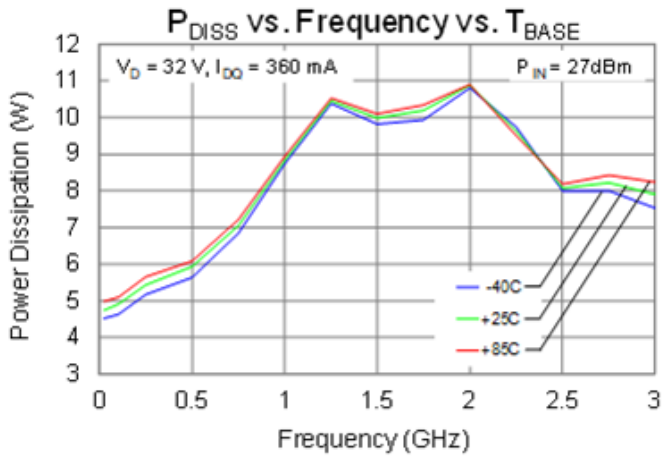

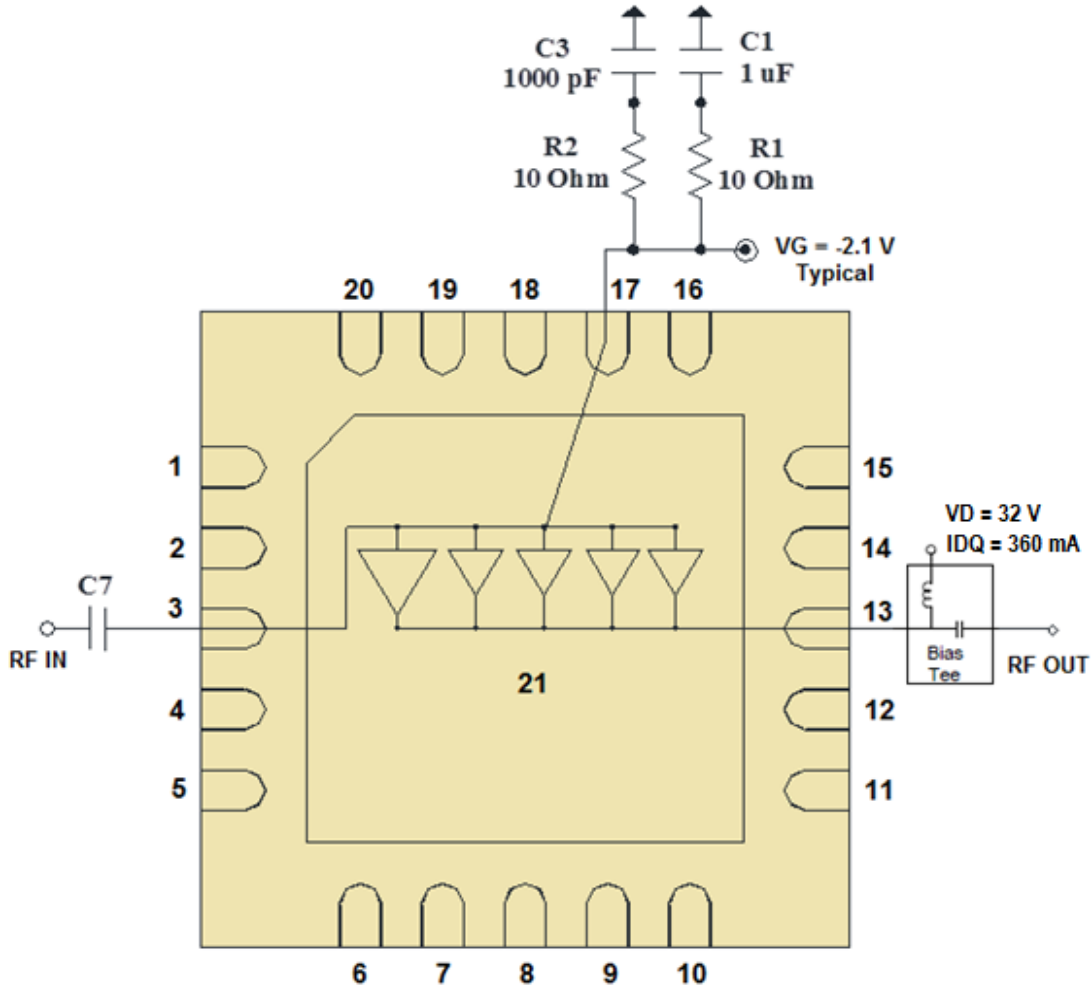
Application Circuit (Coaxial input DC Block and Coaxial Output Bias-T Option)

Notes:

1. Coaxial input DC block (C7) is used for input port (RF In.)
2. External wide bandwidth Bias-Tee is used for output port (RF Out). V_D is applied through the output Bias-Tee.

Bias Up Procedure

1. Set I_D limit to 700mA, I_G limit to 15mA
2. Set V_G to -5.0V
3. Set V_D +32V
4. Adjust V_G more positive until $I_{DQ} = 360\text{mA}$ ($V_G \sim -2.1\text{V}$ Typical)
5. Apply RF signal

Bias Down Procedure

1. Turn off RF signal
2. Reduce V_G to -5.0V. Ensure $I_{DQ} \sim 0\text{mA}$
3. Set V_D to 0V
4. Turn off V_D supply
5. Turn off V_G supply

EVB Layout (Coaxial input DC Block and Coaxial Output Bias-T Option)

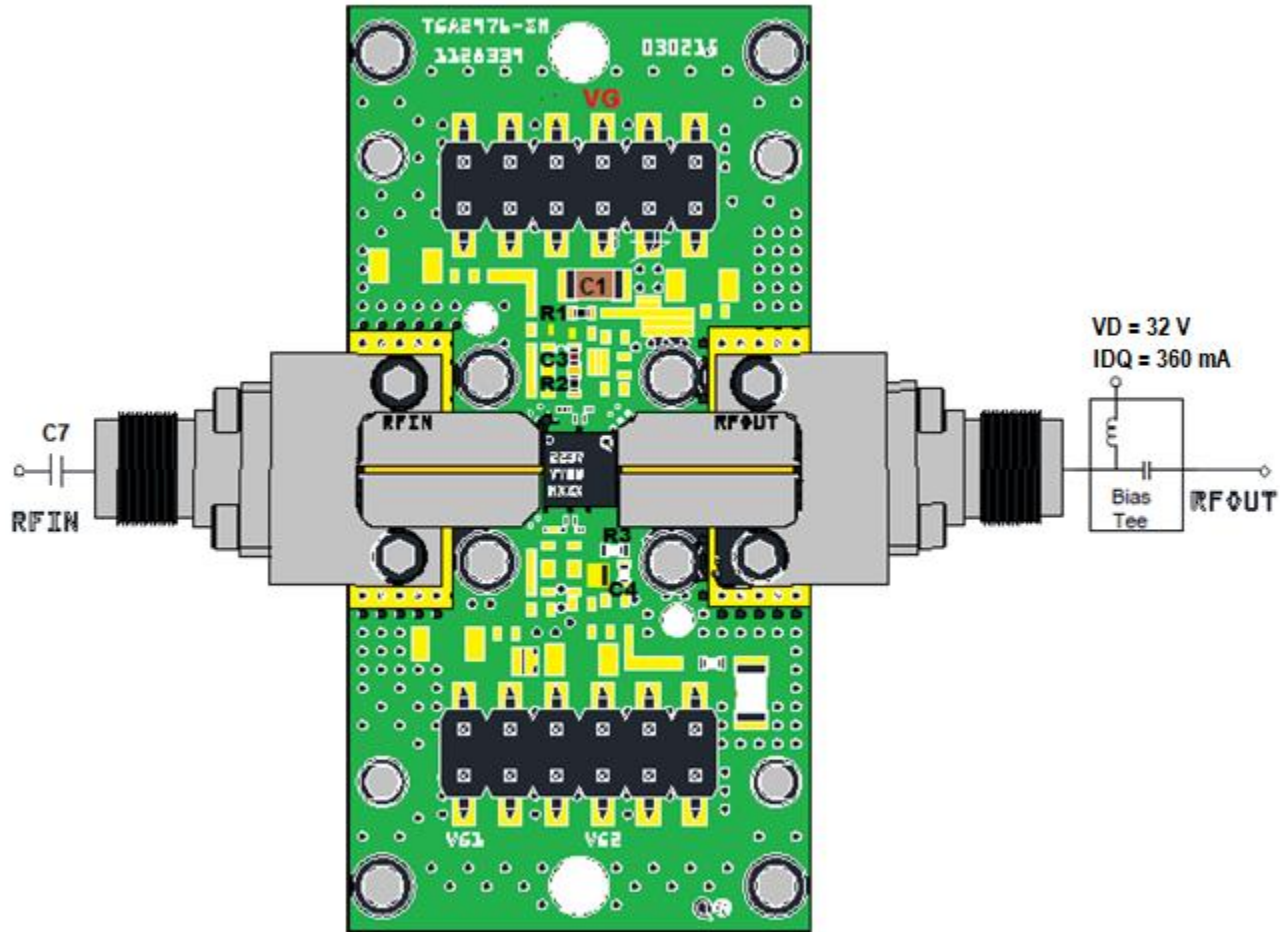

Bill of Materials

Reference Des.	Value	Description	Manuf.	Part Number
C1	1 uF	Cap, 1206, 50V, 5%, X7R	Various	-
C3	1000 pF	Cap, 0402, 100V, 10%, X7R	Various	-
C7		DC Block	Various	-
R1 – R2	10Ω	Res, 0402, 5%, SMD	Various	-

Application Circuit (On-Board DC Blocks and Output Bias-T Option)

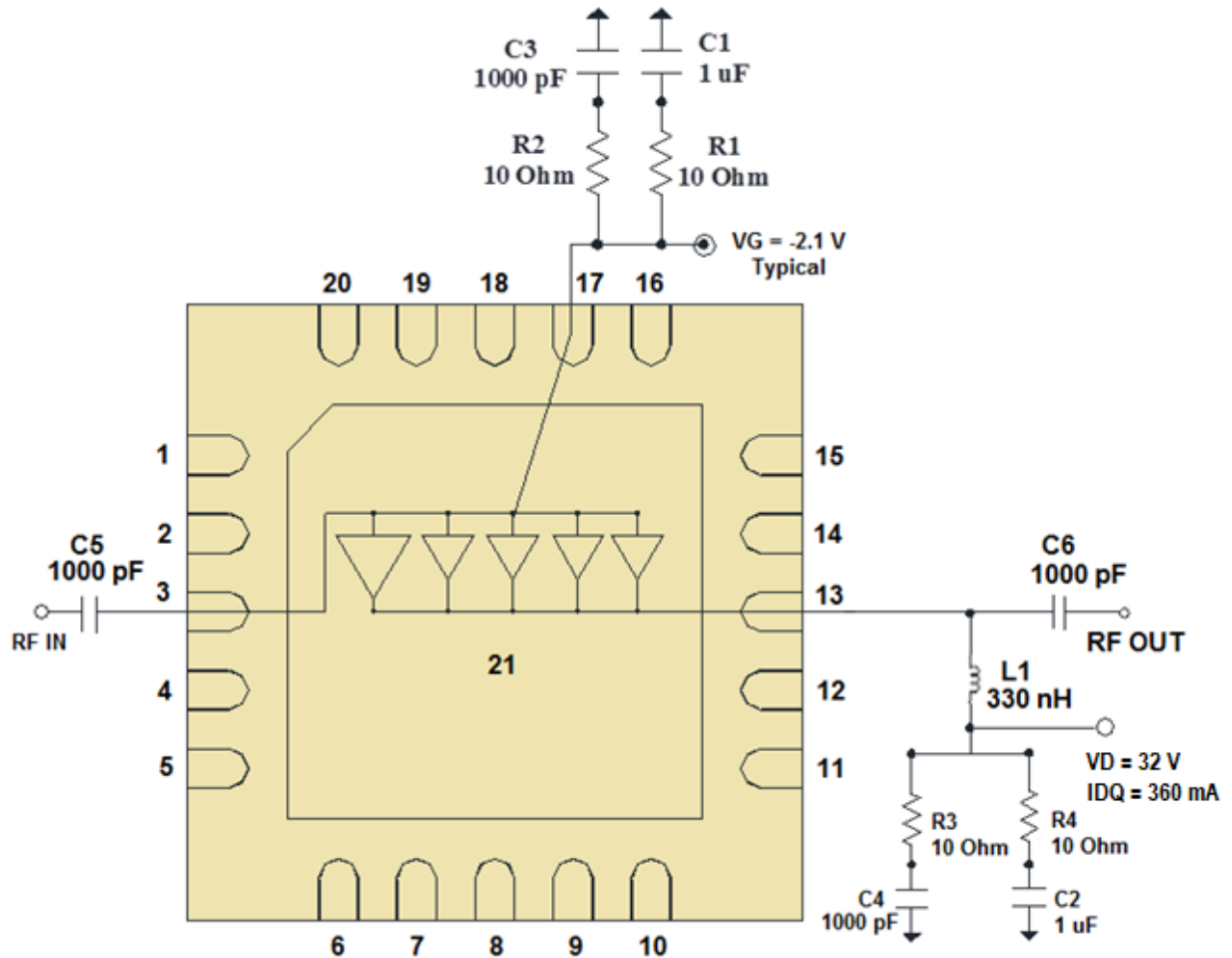

Notes:

1. Performance of the DUT with surface-mount DC blocks and bias tee components may be degraded relative to the coaxial option. These components should be optimized for the desired operational bandwidth.

EVB Layout (On-Board DC Blocks and Output Bias-T Option)

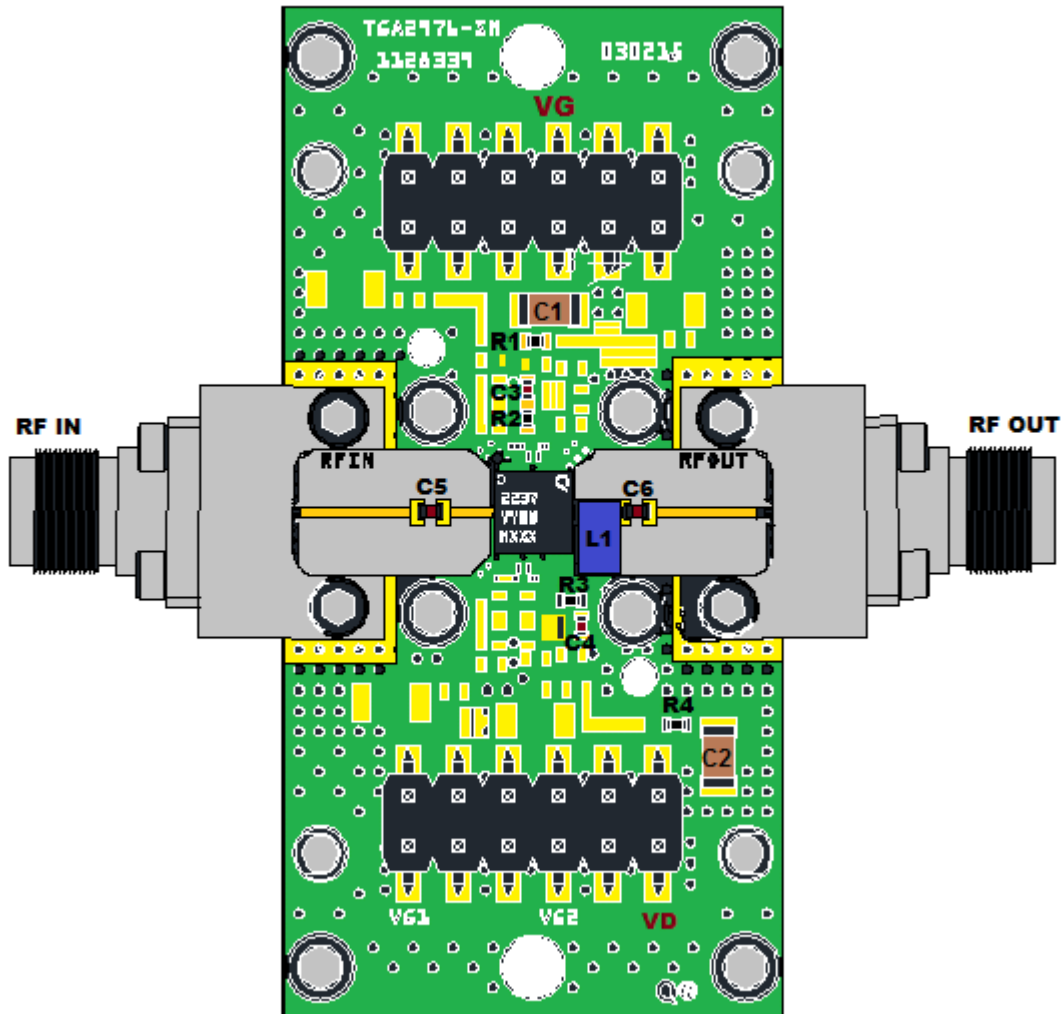

Bill of Materials for On-Board Bias-Tee

Reference Des.	Value	Description	Manuf.	Part Number
C1, C2	1 uF	Cap, 1206, 50V, 5%, X7R	Various	-
C3 – C6	1000 pF	Cap, 0402, 100V, 10%, X7R	Various	-
L1	330 nH	Ind, 1206, 850mA, 5%	Various	-
R1 – R4	10Ω	Res, 0402, 5%, SMD	Various	-

Mechanical Information

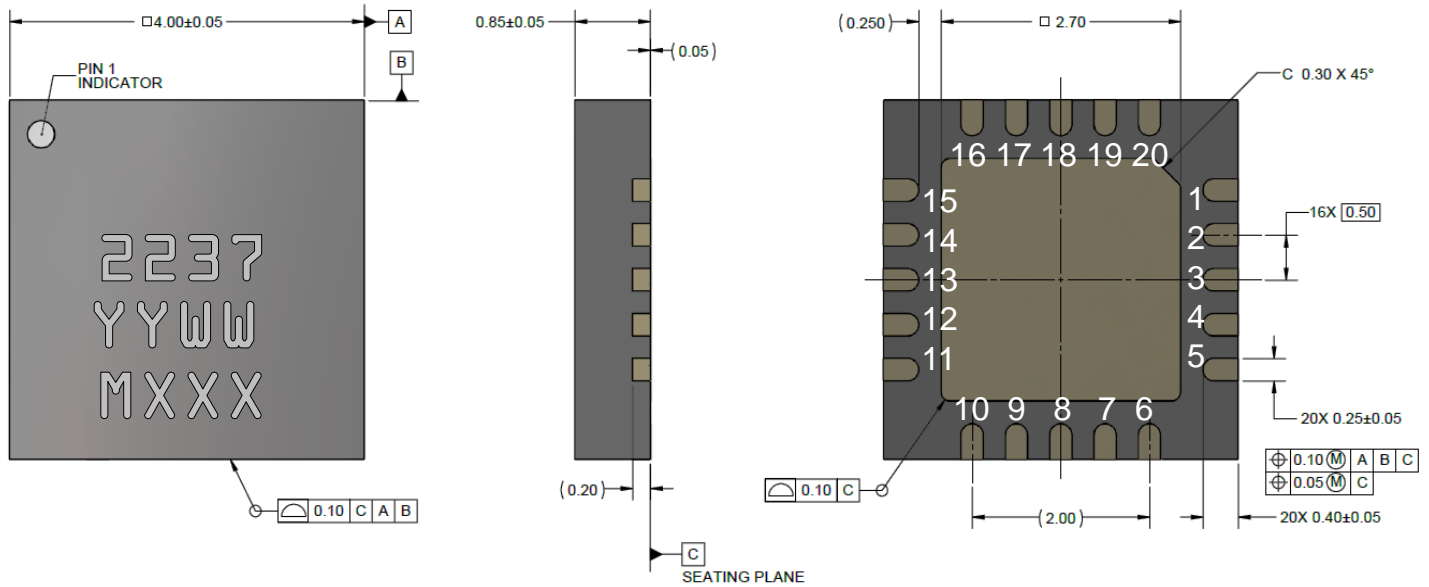

NOTES (UNLESS OTHERWISE SPECIFIED):

1. ALL DIMENSIONS ARE IN MM
2. PACKAGE LEADS ARE GOLD PLATED
3. PART IS MOLD ENCAPSULATED
4. **PART MARKING**
 - 2237: PART NUMBER
 - YY: PART ASSEMBLY YEAR
 - WW: PART ASSEMBLY WEEK
 - XXX: BATCH ID

TOLERANCES

- .XX = $\pm .25$
- .XXX = $\pm .127$
- .XXXX = $\pm .0254$

Pin Description

Pin No.	Symbol	Description
1, 2, 4 – 12, 14 – 16, 18 – 20	N/C	No connection
3	RF IN	Input; matched to 50 Ω .
13	RF OUT/V _D	Output; matched to 50 Ω .
17	V _G	GATE voltage; bias network is required; see recommended Application Information on page 11
21	GND	Ground Paddle. Multiple vias should be employed to minimize inductance and thermal resistance.

Absolute Maximum Ratings

Parameter	Value / Range
Drain Voltage (V_D)	40 V
Gate Voltage Range (V_G)	-8 to 0 V
Drain Current (I_D)	1.2 A
Gate Current (I_G)	See I_{G_Max} plot
Power Dissipation (P_{DISS}), 85 °C	19 W
Input Power (P_{IN}), CW, 50 Ω , 85 °C	33 dBm
Input Power (P_{IN}), CW, VSWR 3:1, $V_D = 32$ V, 85 °C	33 dBm
Max VSWR, CW, $P_{IN} = 27$ dBm, $V_D = 32$ V, 85 °C (Load)	10:1
Mounting Temperature (30 Seconds)	260 °C
Storage Temperature	-55 to 150 °C

Operation of this device outside the parameter ranges given above may cause permanent damage. These are stress ratings only, and functional operation of the device at these conditions is not implied.

Recommended Soldering Temperature Profile

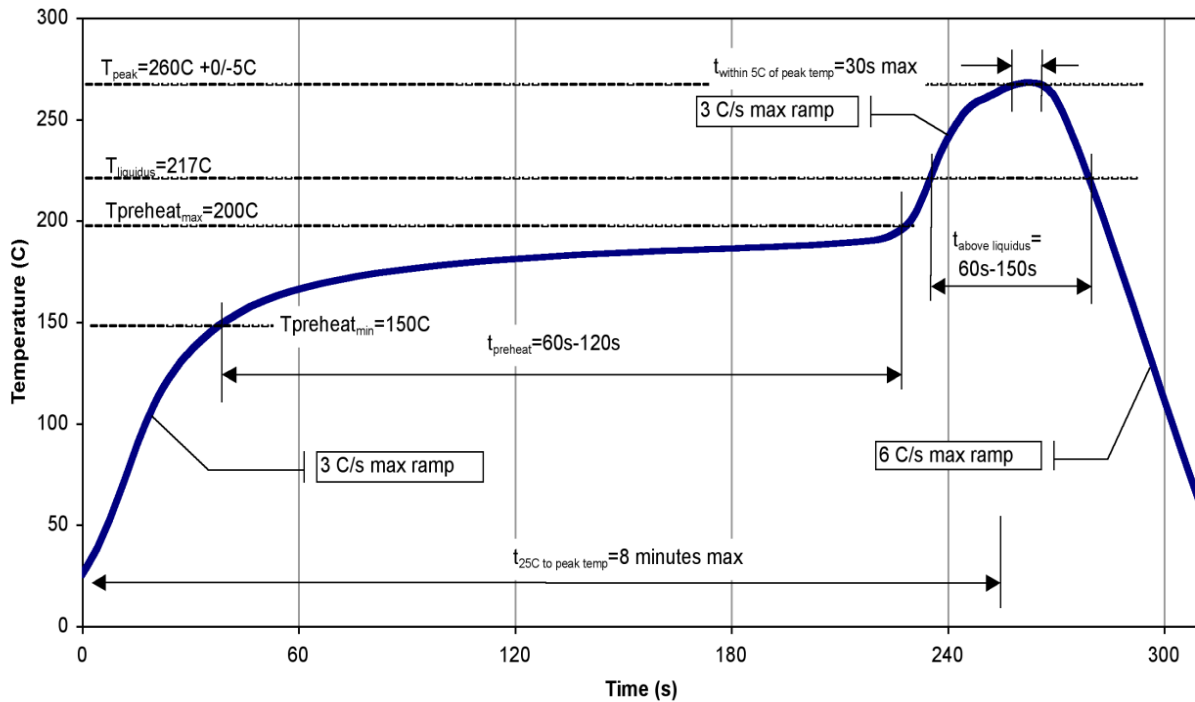

Handling Precautions

Parameter	Rating	Standard
ESD – Human Body Model (HBM)	Class 3A	JEDEC Standard JESD22-A114
ESD – Charge Device Model (CDM)	Class C3	JESD22-C101
MSL – Moisture Sensitivity Level	Level 3	IPC/JEDEC J-STD-020



Caution!
ESD-Sensitive Device

Solderability

Compatible with both lead-free (260°C max. reflow temp.) and tin/lead (245°C max. reflow temp.) soldering processes. The use of no-clean solder to avoid washing after soldering is highly recommended.

RoHS Compliance

This product is compliant with the 2011/65/EU RoHS directive (Restrictions on the Use of Certain Hazardous Substances in Electrical and Electronic Equipment), as amended by Directive 2015/863/EU. This product also has the following attributes:

- Lead Free
- Halogen Free (Chlorine, Bromine)
- Antimony Free
- TBBP-A (C₁₅H₁₂Br₄O₂) Free
- PFOS Free
- SVHC Free

Contact Information

For the latest specifications, additional product information, worldwide sales and distribution locations:

Web: www.qorvo.com

Tel: 1-844-890-8163

Email: customer.support@qorvo.com

Important Notice

The information contained herein is believed to be reliable; however, Qorvo makes no warranties regarding the information contained herein and assumes no responsibility or liability whatsoever for the use of the information contained herein. All information contained herein is subject to change without notice. Customers should obtain and verify the latest relevant information before placing orders for Qorvo products. The information contained herein or any use of such information does not grant, explicitly or implicitly, to any party any patent rights, licenses, or any other intellectual property rights, whether with regard to such information itself or anything described by such information. **THIS INFORMATION DOES NOT CONSTITUTE A WARRANTY WITH RESPECT TO THE PRODUCTS DESCRIBED HEREIN, AND QORVO HEREBY DISCLAIMS ANY AND ALL WARRANTIES WITH RESPECT TO SUCH PRODUCTS WHETHER EXPRESS OR IMPLIED BY LAW, COURSE OF DEALING, COURSE OF PERFORMANCE, USAGE OF TRADE OR OTHERWISE, INCLUDING THE IMPLIED WARRANTIES OF MERCHANTABILITY AND FITNESS FOR A PARTICULAR PURPOSE.**

Without limiting the generality of the foregoing, Qorvo products are not warranted or authorized for use as critical components in medical, life-saving, or life-sustaining applications, or other applications where a failure would reasonably be expected to cause severe personal injury or death.

Copyright 2019 © Qorvo, Inc. | Qorvo is a registered trademark of Qorvo, Inc.