

| Parameter           | Ratings | Units                |
|---------------------|---------|----------------------|
| Blocking Voltage    | 250     | $V_P$                |
| Load Current        | 200     | $mA_{rms} / mA_{DC}$ |
| On-Resistance (max) | 10      | $\Omega$             |

### Features

- 3750V<sub>rms</sub> Input/Output Isolation
- Low Drive Power Requirements
- High Reliability
- Arc-Free With No Snubbing Circuits
- FCC Compatible
- VDE Compatible
- No EMI/RFI Generation
- Small 8-Pin Package
- Flammability Rating UL 94 V-0
- Surface Mount Tape & Reel Versions Available

### Applications

- Telecommunications
  - Telecom Switching
  - Tip/Ring Circuits
  - Modem Switching (Laptop, Notebook, Pocket Size)
  - Hook Switch
  - Dial Pulsing
  - Ground Start
  - Ringing Injection
- Instrumentation
- Multiplexers
- Data Acquisition
- Electronic Switching
- I/O Subsystems
- Meters (Watt-Hour, Water, Gas)
- Medical Equipment-Patient/Equipment Isolation
- Security
- Aerospace
- Industrial Controls

### Description

LBB127 is a 250V, 200mA, 10 $\Omega$ , dual normally closed (1-Form-B) Solid State Relay that comprises two independently controlled, optically coupled MOSFET switches. It is provided in an 8-pin package, and employs optically coupled MOSFET technology to provide 3750V<sub>rms</sub> of input to output isolation.

Its optically coupled outputs, which use the patented OptoMOS architecture, are controlled by a highly efficient infrared LED.

This dual single-pole OptoMOS relay provides a more compact design solution than discrete single-pole relays in a variety of applications, and saves board space by incorporating both switches in a single 8-pin package.

### Approvals

- UL Recognized Component: File E76270
- CSA Certified Component: Certificate 1175739
- EN/IEC 60950-1 Certified Component:  
Certificate available on our website

### Ordering Information

| Part #    | Description                      |
|-----------|----------------------------------|
| LBB127    | 8-Pin DIP (50/Tube)              |
| LBB127S   | 8-Pin Surface Mount (50/Tube)    |
| LBB127STR | 8-Pin Surface Mount (1,000/Reel) |
| LBB127P   | 8-Pin Flatpack (50/Tube)         |
| LBB127PTR | 8-Pin Flatpack (1,000/Reel)      |

### Pin Configuration

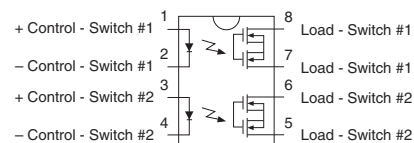

### Switching Characteristics of Normally Closed (Form B) Devices

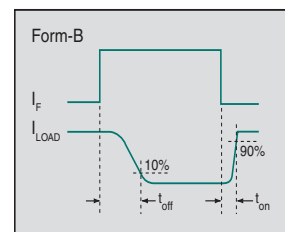

**Absolute Maximum Ratings @ 25°C**

| Parameter                            | Ratings     | Units     |
|--------------------------------------|-------------|-----------|
| Blocking Voltage                     | 250         | $V_P$     |
| Reverse Input Voltage                | 5           | V         |
| Input Control Current                | 50          | mA        |
| Peak (10ms)                          | 1           | A         |
| Input Power Dissipation <sup>1</sup> | 150         | mW        |
| Total Power Dissipation <sup>2</sup> | 800         | mW        |
| Isolation Voltage, Input to Output   | 3750        | $V_{rms}$ |
| Operational Temperature              | -40 to +85  | °C        |
| Storage Temperature                  | -40 to +125 | °C        |

<sup>1</sup> Derate linearly 1.33 mW / °C

<sup>2</sup> Derate linearly 6.67 mW / °C

Absolute Maximum Ratings are stress ratings. Stresses in excess of these ratings can cause permanent damage to the device. Functional operation of the device at conditions beyond those indicated in the operational sections of this data sheet is not implied.

Typical values are characteristic of the device at +25°C, and are the result of engineering evaluations. They are provided for information purposes only, and are not part of the manufacturing testing requirements.

**Electrical Characteristics @ 25°C**

| Parameter                           | Conditions                       | Symbol     | Min | Typ | Max  | Units                |
|-------------------------------------|----------------------------------|------------|-----|-----|------|----------------------|
| <b>Output Characteristics</b>       |                                  |            |     |     |      |                      |
| Load Current                        |                                  |            |     |     |      |                      |
| Continuous <sup>1</sup>             | -                                | $I_L$      | -   | -   | 200  | $mA_{rms} / mA_{DC}$ |
| Peak                                | $t = 10ms$                       | $I_{LPK}$  | -   | -   | ±400 | $mA_P$               |
| On-Resistance                       | $I_L = 200mA$                    | $R_{ON}$   | -   | 8   | 10   | $\Omega$             |
| Off-State Leakage Current           | $V_L = 250V_P$                   | $I_{LEAK}$ | -   | -   | 1    | $\mu A$              |
| Switching Speeds                    |                                  |            |     |     |      |                      |
| Turn-On                             | $I_F = 5mA, V_L = 10V$           | $t_{on}$   | -   | -   | 5    | ms                   |
| Turn-Off                            |                                  | $t_{off}$  | -   | -   | 5    |                      |
| Output Capacitance                  | $I_F = 5mA, V_L = 50V, f = 1MHz$ | $C_{OUT}$  | -   | 50  | -    | pF                   |
| <b>Input Characteristics</b>        |                                  |            |     |     |      |                      |
| Input Control Current to Activate   | $I_L = 200mA$                    | $I_F$      | -   | -   | 5    | mA                   |
| Input Control Current to Deactivate | -                                | $I_F$      | 0.4 | 0.7 | -    | mA                   |
| Input Voltage Drop                  | $I_F = 5mA$                      | $V_F$      | 0.9 | 1.2 | 1.5  | V                    |
| Reverse Input Current               | $V_R = 5V$                       | $I_R$      | -   | -   | 10   | $\mu A$              |
| <b>Common Characteristics</b>       |                                  |            |     |     |      |                      |
| Input to Output Capacitance         | $V_{IO} = 0V, f = 1MHz$          | $C_{IO}$   | -   | 3   | -    | pF                   |

<sup>1</sup> If both poles operate, then the load current must be derated so as not to exceed the package power dissipation value.

PERFORMANCE DATA\*

Typical LED Forward Voltage Drop  
(N=50,  $I_F=5mA$ )

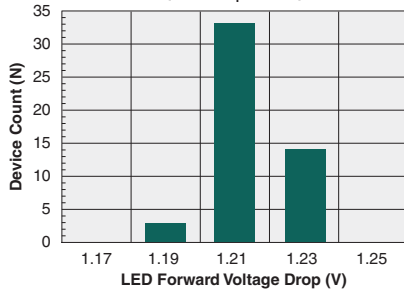

Typical Turn-On Time  
(N=50,  $I_F=5mA$ ,  $I_L=200mA$ )

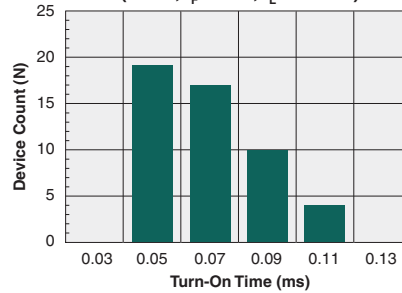

Typical Turn-Off Time  
(N=50,  $I_F=5mA$ ,  $I_L=200mA$ )

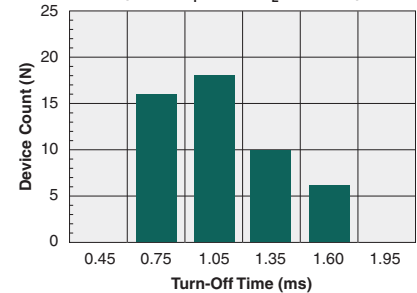

Typical  $I_F$  for Switch Operation  
(N=50,  $I_L=200mA$ )

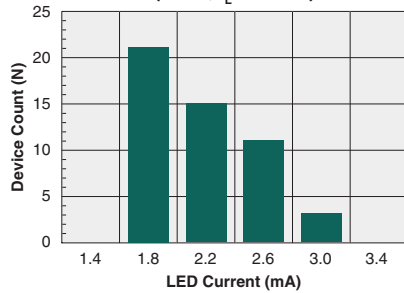

Typical  $I_F$  for Switch Dropout  
(N=50,  $I_L=200mA$ )

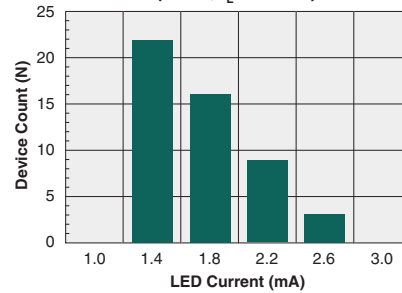

Typical On-Resistance Distribution  
(N=50,  $I_F=5mA$ ,  $I_L=200mA$ )

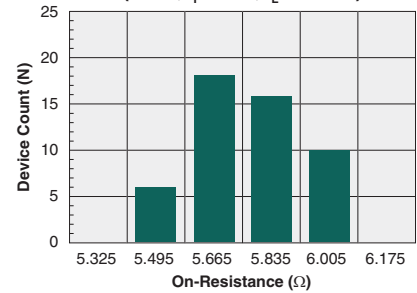

Typical Blocking Voltage Distribution  
(N=50,  $I_F=5mA$ )

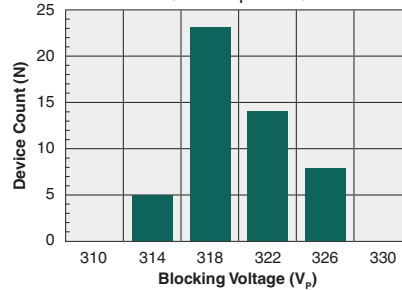

Typical LED Forward Voltage Drop  
vs. Temperature

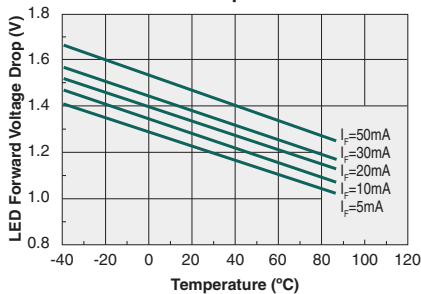

Typical Turn-On Time  
vs. LED Forward Current  
( $I_L=200mA$ )

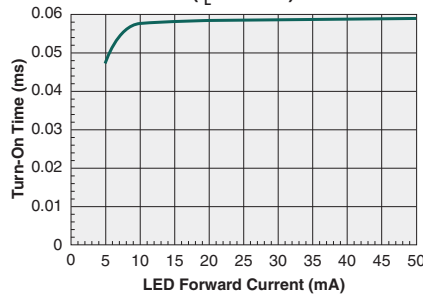

Typical Turn-Off Time  
vs. LED Forward Current  
( $I_L=200mA$ )

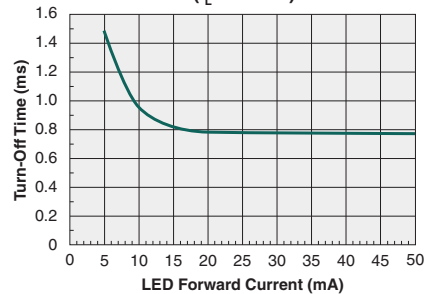

\*Unless otherwise noted, data presented in these graphs is typical of device operation at 25°C.  
For guaranteed parameters not indicated in the written specifications, please contact our application department.

**PERFORMANCE DATA\***

**Typical Turn-On Time vs. Temperature**  
( $I_F=5mA, I_L=200mA$ )

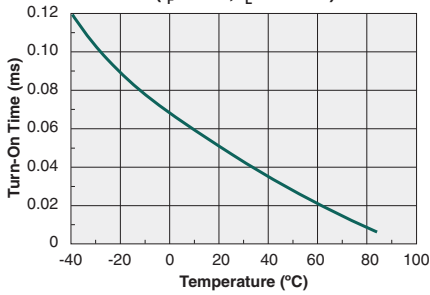

**Typical Turn-Off Time vs. Temperature**  
( $I_L=200mA$ )

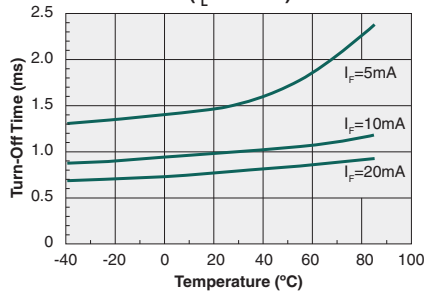

**Maximum Load Current vs. Temperature**

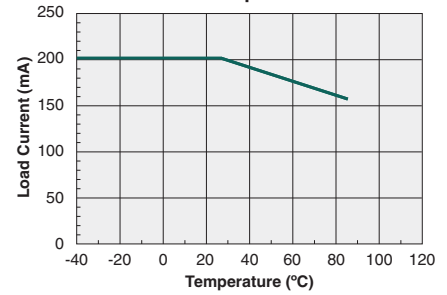

**Typical  $I_F$  for Switch Operation vs. Temperature**  
( $I_L=200mA$ )

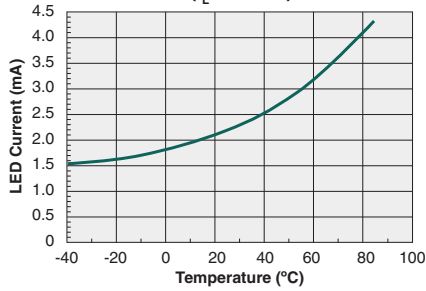

**Typical  $I_F$  for Switch Dropout vs. Temperature**  
( $I_L=200mA$ )

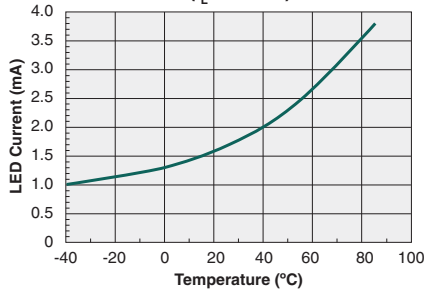

**Typical On-Resistance vs. Temperature**  
( $I_F=5mA, I_L=200mA$ )

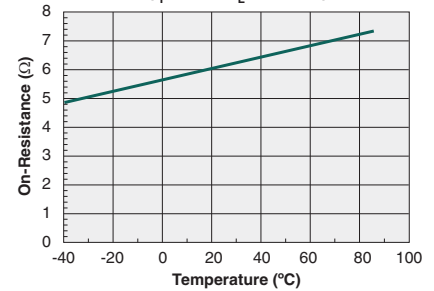

**Typical Load Current vs. Load Voltage**

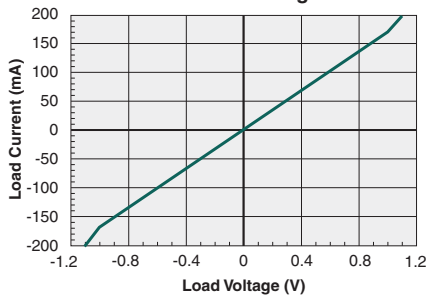

**Typical Blocking Voltage vs. Temperature**  
( $I_F=5mA$ )

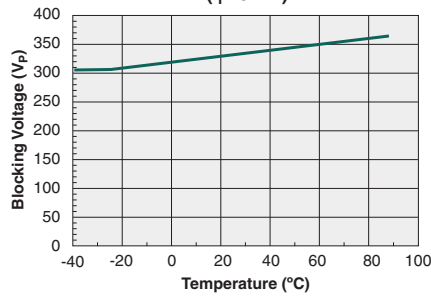

**Typical Leakage vs. Temperature Measured across Pins 5&6 or 7&8**

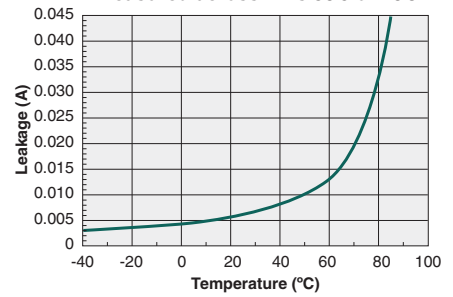

**Energy Rating Curve**

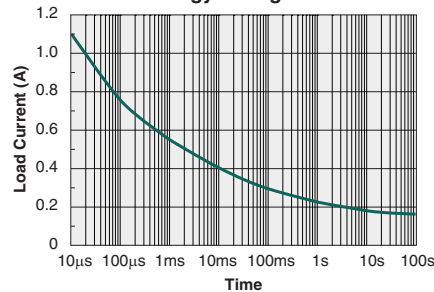

\*Unless otherwise noted, data presented in these graphs is typical of device operation at 25°C.  
For guaranteed parameters not indicated in the written specifications, please contact our application department.

## Manufacturing Information

### Moisture Sensitivity



All plastic encapsulated semiconductor packages are susceptible to moisture ingress. IXYS Integrated Circuits classifies its plastic encapsulated devices for moisture sensitivity according to the latest version of the joint industry standard, **IPC/JEDEC J-STD-020**, in force at the time of product evaluation. We test all of our products to the maximum conditions set forth in the standard, and guarantee proper operation of our devices when handled according to the limitations and information in that standard as well as to any limitations set forth in the information or standards referenced below.

Failure to adhere to the warnings or limitations as established by the listed specifications could result in reduced product performance, reduction of operable life, and/or reduction of overall reliability.

This product carries a Moisture Sensitivity Level (MSL) classification as shown below, and should be handled according to the requirements of the latest version of the joint industry standard **IPC/JEDEC J-STD-033**.

| Device                     | Moisture Sensitivity Level (MSL) Classification |
|----------------------------|---|
| LBB127 / LBB127S / LBB127P | MSL 1   |

### ESD Sensitivity



This product is **ESD Sensitive**, and should be handled according to the industry standard **JESD-625**.

### Soldering Profile

Provided in the table below is the Classification Temperature ( $T_C$ ) of this product and the maximum dwell time the body temperature of this device may be ( $T_C - 5$ )°C or greater. The classification temperature sets the Maximum Body Temperature allowed for this device during lead-free reflow processes. For through-hole devices, and any other processes, the guidelines of **J-STD-020** must be observed.

| Device  | Classification Temperature ( $T_C$ ) | Dwell Time ( $t_p$ ) | Max Reflow Cycles |
|---------|--------------------------------------|----------------------|-------------------|
| LBB127  | 250°C                                | 30 seconds           | 1                 |
| LBB127S | 250°C                                | 30 seconds           | 3                 |
| LBB127P | 260°C                                | 30 seconds           | 3                 |

### Board Wash

IXYS Integrated Circuits recommends the use of no-clean flux formulations. Board washing to reduce or remove flux residue following the solder reflow process is acceptable provided proper precautions are taken to prevent damage to the device. These precautions include, but are not limited to: using a low pressure wash and providing a follow up bake cycle sufficient to remove any moisture trapped within the device due to the washing process. Due to the variability of the wash parameters used to clean the board, determination of the bake temperature and duration necessary to remove the moisture trapped within the package is the responsibility of the user (assembler). Cleaning or drying methods that employ ultrasonic energy may damage the device and should not be used. Additionally, the device must not be exposed to flux or solvents that are Chlorine- or Fluorine-based.



MECHANICAL DIMENSIONS

LBB127

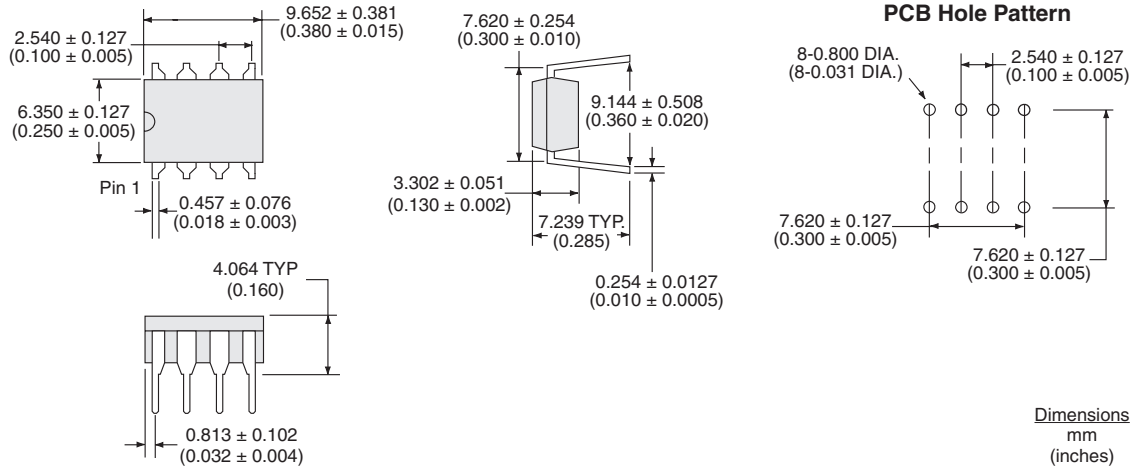

LBB127S

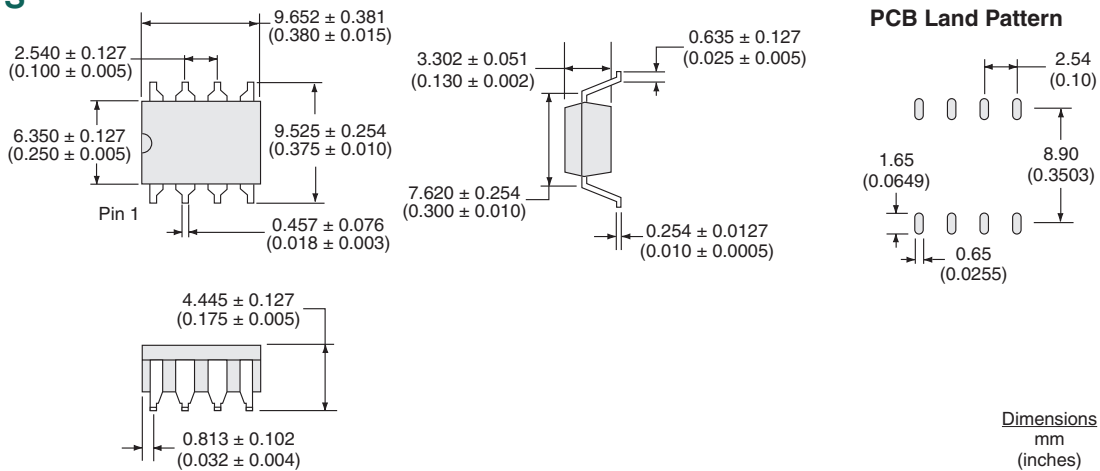

LBB127P

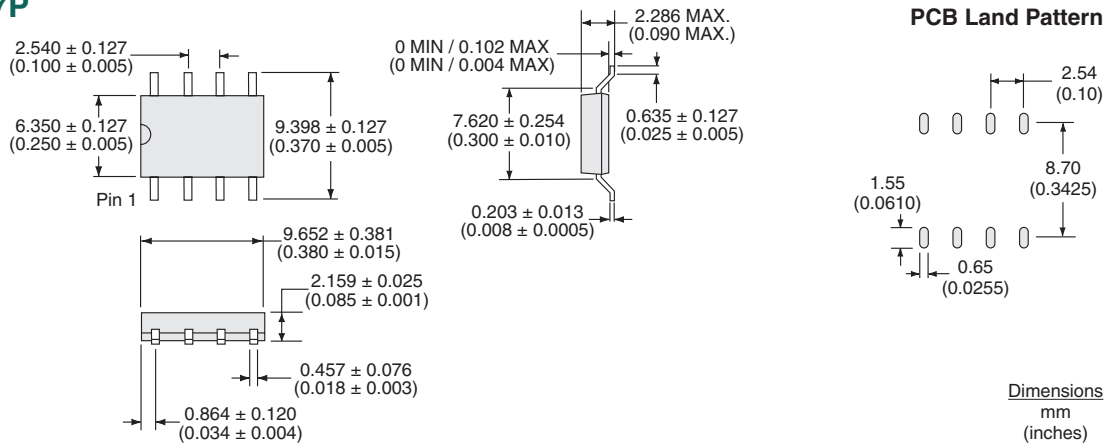

### MECHANICAL DIMENSIONS

#### LBB127STR Tape & Reel

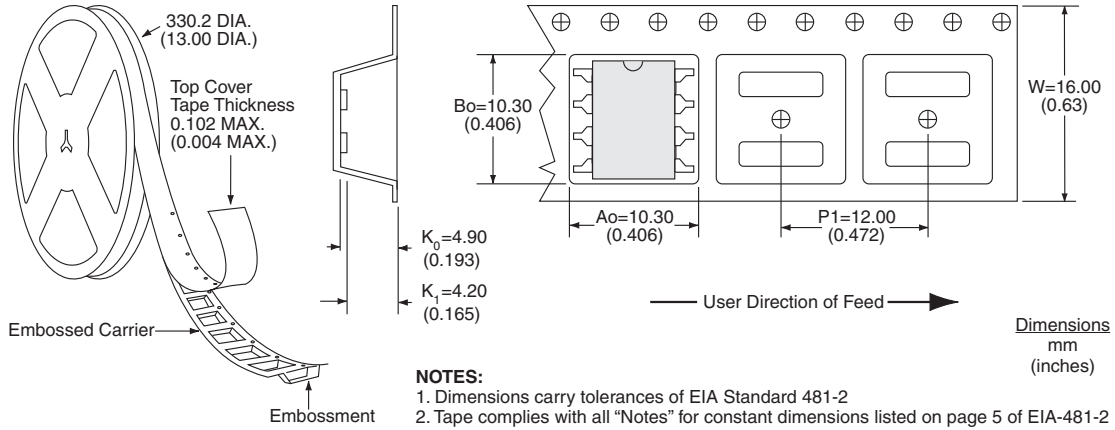

#### LBB127PTR Tape & Reel

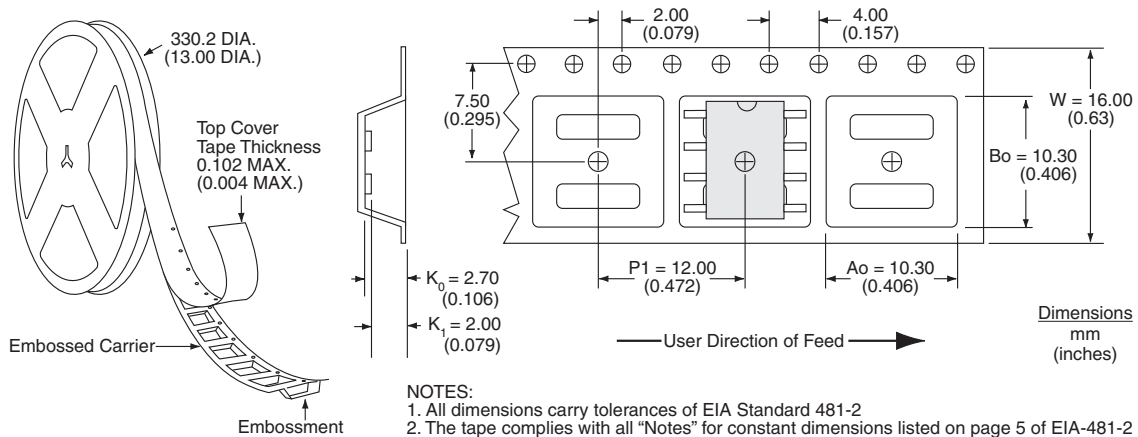

For additional information please visit our website at: [www.ixysic.com](http://www.ixysic.com)

IXYS Integrated Circuits makes no representations or warranties with respect to the accuracy or completeness of the contents of this publication and reserves the right to make changes to specifications and product descriptions at any time without notice. Neither circuit patent licenses nor indemnity are expressed or implied. Except as set forth in IXYS Integrated Circuits' Standard Terms and Conditions of Sale, IXYS Integrated Circuits assumes no liability whatsoever, and disclaims any express or implied warranty, relating to its products including, but not limited to, the implied warranty of merchantability, fitness for a particular purpose, or infringement of any intellectual property right.

The products described in this document are not designed, intended, authorized or warranted for use as components in systems intended for surgical implant into the body, or in other applications intended to support or sustain life, or where malfunction of IXYS Integrated Circuits' product may result in direct physical harm, injury, or death to a person or severe property or environmental damage. IXYS Integrated Circuits reserves the right to discontinue or make changes to its products at any time without notice.