

Series 02

Characteristics

The robust Series 02 is especially suited for:

- Flush design

The rectangular construction (24x36 mm) provides large surfaces for illumination and labelling.

Functions

The Series 02 incorporates the following functions:

- Indicator
- Pushbutton
- Illuminated pushbutton
- Keylock switch
- Buzzer

Market segments

The EAO Series 02 is especially suited for applications in the segments:

- Ship building
- Panel building

Please refer to the EAO website to obtain detailed information regarding this series www.products.eao.com
Configure a product to your exact needs and request a quotation.



Overview**Flush design**

Indicator	4
Buzzer	5
Pushbutton	6
Illuminated pushbutton	7
Mushroom-head pushbutton	8
Keylock switch	9
Mushroom-head keylock pushbutton	10

Accessories**11****Technical data****21****Marking****23****Application guidelines****24****Index****25**

02 Flush design

Indicator, IP 40



Product can differ from the current configuration.



Dimensions [mm]

Additional Information

- For front dimension 24 x 36 mm
- For indicator 02-07x.00x can only filament lamps be used (no LEDs)
- For LED element fitting information see chapter «Application guidelines»
- Take note of heat generating



Mounting cut-outs [mm]

Equipment consisting of (schematic overview)



Each article number listed below includes all the black components shown in the 3D-drawing.

To obtain a complete unit, please select the red components from the pages shown.

Product attribute	Behind panel depth	Terminal	Part No.	Wiring diagram	Weight
 <p>Indicator actuator without serie resistor, for LED or filament lamp</p>	60 mm	Screw	02-021.001	1	0.030 kg
 <p>Indicator actuator with built-in lamp series resistor, 240 VAC/DC to 48 V, 25 mA, for filament lamp</p>	84 mm	Screw	02-070.001	1	0.045 kg
with built-in lamp series resistor, 110 VAC/DC to 48 V, 25 mA, for filament lamp	84 mm	Screw	02-071.001	1	0.045 kg
with built-in lamp series resistor, 125 VAC/DC to 48 V, 25 mA, for filament lamp	84 mm	Screw	02-072.001	1	0.045 kg
with built-in lamp series resistor and diode, 240 VAC/DC to 48 V, 25 mA, for filament lamp	84 mm	Screw	02-073.001	1	0.045 kg



Buzzer, IP 40

Equipment consisting of (schematic overview)



Front bezel page 13



Buzzer



Fixing bezel



Dimensions [mm]



Product can differ from the current configuration.

Each article number listed below includes all the black components shown in the 3D-drawing.

To obtain a complete unit, please select the red components from the pages shown.



Mounting cut-outs [mm]

Additional Information

- For front dimension 24 x 36 mm
- Further information in chapter «Technical Data»

Operating voltage	Front cap	Terminal	Part No.	Wiring diagram	Weight
 <p>Buzzer</p>					
10 ... 55 VAC, 10 ... 75 VDC	Pastic black	Screw	02-810.001	1	0.060 kg



02 Flush design

Pushbutton, IP 40



Product can differ from the current configuration.



Dimensions [mm]

Additional Information

- For front dimension 24 x 36 mm



Mounting cut-outs [mm]

Equipment consisting of (schematic overview)



Each article number listed below includes all the black components shown in the 3D-drawing.

To obtain a complete unit, please select the red components from the pages shown.

Contacts	Switching action	Terminal	Part No.	Wiring diagram	Weight
	A	Screw	02-611.011	1	0.045 kg
	C	Screw	02-613.011	2	0.045 kg
2 C	A	Screw	02-612.011	3	0.050 kg
	C	Screw	02-614.011	4	0.050 kg
	B - C	Screw	02-615.011	5	0.050 kg

Contacts: C = Changeover

Switching action: B = Momentary, C = Maintain



Illuminated pushbutton, IP 40

Equipment consisting of (schematic overview)



Front bezel page 13



Lens page 11



LED page 17



Actuator



Fixing bezel

Each article number listed below includes all the black components shown in the 3D-drawing.

To obtain a complete unit, please select the red components from the pages shown.



Dimensions [mm] [mm]



Mounting cut-outs [mm]



Product can differ from the current configuration.

Additional Information

- For front dimension 24 x 36 mm
- For LED element fitting information see chapter «Application guidelines»

Contacts	Switching action	Terminal	Part No.	Wiring diagram	Gewicht
 Illuminated pushbutton actuator					
1 C	B	Screw	02-616.011	1	0.050 kg
	C	Screw	02-618.011	2	0.050 kg
2 C	B	Screw	02-617.011	3	0.055 kg
	C	Screw	02-619.011	4	0.055 kg
	B - C	Screw	02-620.011	5	0.055 kg

Contacts: C = Changeover

Switching action: B = Momentary, C = Maintain



02 Flush design

Mushroom-head pushbutton, IP 40

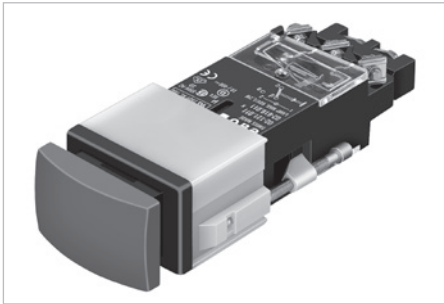

Product can differ from the current configuration.



Additional Information

- For front dimension 24 x 36 mm
- Use only flush front bezel

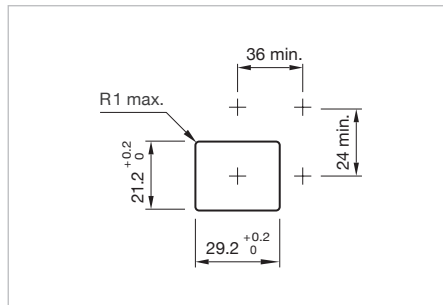

Equipment consisting of (schematic overview)



Mushroom-head cap page 11



Front bezel page 13

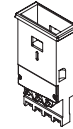

Actuator



Fixing sleeve

Each Part Number listed below includes all the black components shown in the 3D-drawing.

To obtain a complete unit, please select the red components from the pages shown.

Contacts	Switching action	Terminal	Part No.	Wiring diagram	Weight
 Mushroom-head pushbutton actuator					
1 C	B	Screw	02-611.011	1	0.045 kg
	C	Screw	02-613.011	2	0.045 kg
2 C	B	Screw	02-612.011	3	0.050 kg
	C	Screw	02-614.011	4	0.050 kg
	B - C	Screw	02-615.011	5	0.050 kg

Contacts: C = Changeover

Switching action: B = Momentary, C = Maintain

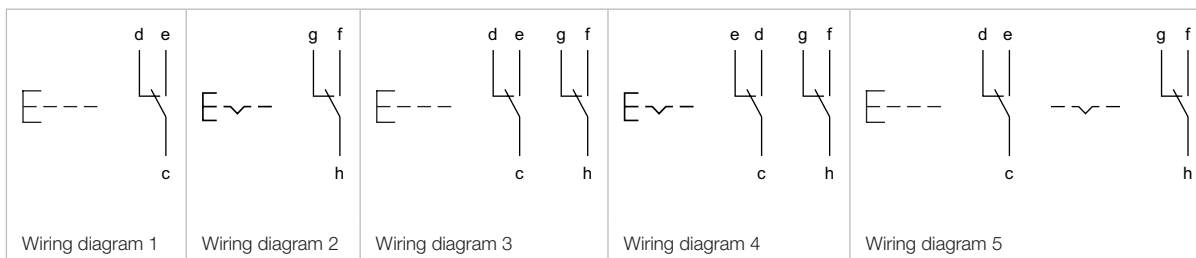

Keylock switch 2 positions, IP 40

Equipment consisting of (schematic overview)



Front bezel page 13



Keylock front bezel page 12



Actuator



Fixing bezel

Each article number listed below includes all the black components shown in the 3D-drawing.

To obtain a complete unit, please select the red components from the pages shown.



Dimensions [mm]



Product can differ from the current configuration.



Mounting cut-outs [mm]

Additional Information

- For front dimension 24 x 36 mm
- Front plastic grey
- Keylock number YB1
- After turning the key 90° clockwise, the switch can be operated
- In the unlocked switch positions always perform a momentary action
- Two keys are supplied with each key lock switch



Switching positions (A = Rest, B = Momentary)

Product attribute	Contacts	Switching angle	Key remove	Terminal	Part No.	Wiring diagram	Gewicht
							
Schlüsselschalter-Vorsatz 2 Stellungen							
A = lockable, actuated	2 C	B = 90°	A	Screw	02-690.011	1	0.055 kg
A = lockable, non-actuated or actuated	2 C	B = 90°	A	Screw	02-692.011	1	0.055 kg
A = lockable, non-actuated	2 C	B = 90°	A	Screw	02-691.011	1	0.055 kg

Contacts: C = Changeover



02 Flush design

Keylock switch 2 positions, IP 40



Product can differ from the current configuration.



Dimensions [mm]

Additional Information

- For front dimension 24 x 36 mm
- Front plastic grey
- Keylock number YB1
- After turning the key 90° clockwise, the switch can be operated
- In the unlocked switch positions always perform a momentary action
- Two keys are supplied with each key lock switch



Mounting cut-outs [mm]

Equipment consisting of (schematic overview)



Front bezel page 13



Keylock front bezel



Actuator



Fixing bezel

Each article number listed below includes all the black components shown in the 3D-drawing.

To obtain a complete unit, please select the red components from the pages shown.



Switching positions (A = Rest, B = Momentary)

Product attribute	Contacts	Switching angle	Key remove	Terminal	Part No.	Wiring diagram	Gewicht
							
Schlüsselschalter-Vorsatz 2 Stellungen							
A = lockable, non-actuated, B = lockable, key not removable	2 C	B = 90°	A	Screw	02-695.011	1	0.055 kg
A = lockable, non-actuated or actuated; can be used with protective cover Part No. 22-925	2 C	B = 90°	A	Screw	02-198.011	1	0.055 kg

Contacts: C = Changeover

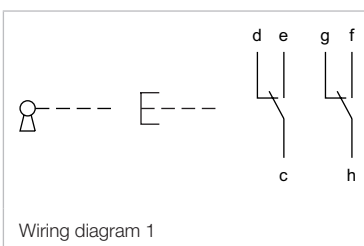

Front

Lens

Additional Information

- Material plastic

Product attribute	Dimension	Lens	Part No.	Weight		
 <p>Lens</p>	17.5 x 25.4 mm	illuminative, not suitable for film insert, ripped	smoked translucent	02-901.1	0.004 kg	
		red translucent	02-901.2	0.004 kg		
		orange translucent	02-901.3	0.004 kg		
		yellow translucent	02-901.4	0.004 kg		
		green translucent	02-901.5	0.004 kg		
		blue translucent	02-901.6	0.004 kg		
		colourless transparent	02-901.7	0.004 kg		
		white translucent	02-901.9	0.004 kg		
		illuminative, use holder for film insert	17.5 x 25.4 mm	red translucent	02-902.2	0.004 kg
				green translucent	02-902.5	0.004 kg
colourless transparent	02-902.7			0.004 kg		
non-illuminative	17.5 x 25.4 mm	black opaque	02-901.0	0.004 kg		
		grey opaque	02-901.8	0.004 kg		

Keylock front bezel

Additional Information

- Keylock number YB1
- Further lock numbers see «Technical data»

Product attribute	Dimension	Material	Colour	Part No.	Weight	
 <p>Keylock front bezel</p>	17.5 x 25.5 mm	Plastic	grey	02-980.1	0.002 kg	
	for keylock switch Part No. 02-695	17.5 x 25.5 mm	Plastic	grey	02-982.1	0.002 kg

02 Accessories

Holder

Additional Information

- For lens with film insert

Material	Colour	Optics	Part No.	Weight
 Holder				
Plastic	red	translucent	02-908.2	0.001 kg
	orange	translucent	02-908.3	0.001 kg
	yellow	translucent	02-908.4	0.001 kg
	green	translucent	02-908.5	0.001 kg
	blue	translucent	02-908.6	0.001 kg
	colourless	transparent	02-908.7	0.001 kg
	white	translucent	02-908.9	0.001 kg

Diffusor plate

Additional Information

- For lens with film insert

Part No.	Weight
 Diffusor plate	
02-909	0.001 kg

Front bezel flush

Additional Information

- Lens only removable with lens remover
Part No. 02-905

Front bezel	Part No.	Weight
 Front bezel flush, Front dimension 24 x 36 mm		
Pastic black	02-965.0	0.001 kg

Front bezel raised

Additional Information

- Lens only removable with lens remover
Part No. 98-969

Front bezel	Part No.	Weight
 <p>Front bezel raised, Front dimension 24 x 36 mm</p>		
Pastic black	02-967.0	0.001 kg

Protective cover, IP 65

Additional Information

- Please note that bigger minimum distances are necessary
- Use only flush front bezel
- Hinged, with means for sealing
- Front panel thickness reduces by 2 mm

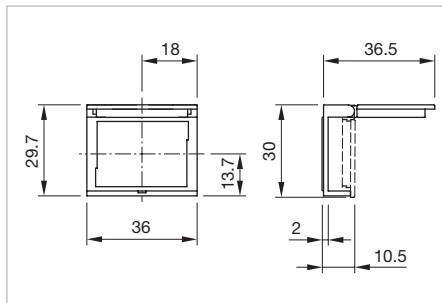

Dimensions [mm]

Product attribute	Material	Optics	Dimension	Part No.	Weight
 <p>Protective cover</p>					
for button with mounting cut-out 21.2 x 29.2 mm	Plastic	transparent	36 x 29.7 mm	22-925	0.004 kg

02 Accessories

Spare key

Additional Information

- Keylock number YB1

Part No.	Weight
 <p>Spare key</p>	
02-989.001	0.001 kg

Front protective cap, IP 65

Additional Information

- Use only flush front bezel
- Three-part



Dimensions [mm]



Mounting cut-outs [mm]

Material	Colour	Optics	Temperature	Part No.	Weight
 <p>Front protective cap</p>					
PVC	colourless	transparent	-20 ... +60 °	02-924	0.005 kg
			-25 ... +85 °	02-935	0.005 kg

Blind plug



Mounting cut-outs [mm]

Dimension	Material	Colour	Part No.	Weight
 <p>Blind plug</p>	Plastic	black	02-949.0	0.004 kg
		grey	02-949.8	0.004 kg

02 Accessories

Backside

Terminal cover

Additional Information

- For all connection methods
- Not suitable for indicators with built-in series resistor with lamp

Part No.	Weight
 Terminal cover	
02-929	0.005 kg

Illumination

Single-LED, T6.8

Additional Information

- For LED element fitting information see «Application guidelines»
- Due to high surface temperatures, the series resistor must not be soldered directly to the terminals of the equipment (use a terminal plate)
- When using AC/DC types with AC operation, slight flickering can occur
- Luminous intensity data of the LEDs on direct voltage
- Electrical and optical data are measured at 25 °C
- The specified versions are built with a protection diode (half wave rectifier) in series and the LED
- Luminosity and wave length variations caused by LED manufacturing processes may cause slight differences regarding the illumination
- For supply voltages above 48 V, it is necessary to use a voltage reduction element (external series resistor or transformer)



Dimensions [mm]

LED colour	Operating voltage	Operation current	Lumi. intensity	Dom. wavelength	Part No.	Weight
 <p>Single-LED</p>						
red	6 VDC	17 mA ± 15 %	400 mcd	630 nm	10-2K06.3152	0.002 kg
	12 VAC/DC	9/17 mA ± 15 %	400 mcd	630 nm	10-2K09.1072	0.002 kg
	24 VAC/DC	9/17 mA ± 15 %	400 mcd	630 nm	10-2K12.1072	0.002 kg
	28 VAC/DC	9/17 mA ± 15 %	400 mcd	630 nm	10-2K13.1072	0.002 kg
	48 VAC/DC	4/8 mA ± 15 %	200 mcd	630 nm	10-2K19.1052	0.002 kg
yellow	6 VDC	17 mA ± 15 %	340 mcd	340 nm	10-2K06.3154	0.002 kg
	12 VAC/DC	9/17 mA ± 15 %	340 mcd	340 nm	10-2K09.1074	0.002 kg
	24 VAC/DC	9/17 mA ± 15 %	340 mcd	340 nm	10-2K12.1074	0.002 kg
	28 VAC/DC	9/17 mA ± 15 %	340 mcd	340 nm	10-2K13.1074	0.002 kg
	48 VAC/DC	4/8 mA ± 15 %	180 mcd	340 nm	10-2K19.1054	0.002 kg
green	6 VDC	7 mA ± 15 %	1050 mcd	525 nm	10-2K06.3155	0.002 kg
	12 VAC/DC	4/7 mA ± 15 %	1050 mcd	525 nm	10-2K09.1075	0.002 kg
	24 VAC/DC	4/7 mA ± 15 %	1050 mcd	525 nm	10-2K12.1075	0.002 kg
	28 VAC/DC	4/7 mA ± 15 %	1050 mcd	525 nm	10-2K13.1075	0.002 kg
	48 VAC/DC	2/4 mA ± 15 %	600 mcd	525 nm	10-2K19.1055	0.002 kg
blue	6 VDC	17 mA ± 15 %	780 mcd	470 nm	10-2K06.3156	0.002 kg
	12 VAC/DC	9/17 mA ± 15 %	780 mcd	470 nm	10-2K09.1076	0.002 kg
	24 VAC/DC	9/17 mA ± 15 %	780 mcd	470 nm	10-2K12.1076	0.002 kg
	28 VAC/DC	9/17 mA ± 15 %	780 mcd	470 nm	10-2K13.1076	0.002 kg
	48 VAC/DC	4/8 mA ± 15 %	400 mcd	470 nm	10-2K19.1056	0.002 kg

02 Accessories

LED colour	Operating voltage	Operation current	Lumi. intensity	Dom. wavelength	Part No.	Weight
white	6 VDC	6 mA ±15 %	900 mcd	x0.31/y0.32 nm	10-2K06.3159	0.002 kg
	12 VAC/DC	3/6 mA ±15 %	900 mcd	x0.31/y0.32 nm	10-2K09.1079	0.002 kg
	24 VAC/DC	3/6 mA ±15 %	900 mcd	x0.31/y0.32 nm	10-2K12.1079	0.002 kg
	28 VAC/DC	2.5/5 mA ±15 %	750 mcd	x0.31/y0.32 nm	10-2K13.1079	0.002 kg
	48 VAC/DC	2/4 mA ±15 %	600 mcd	x0.31/y0.32 nm	10-2K19.1059	0.002 kg

Filament lamp, T6.8

Operating voltage	Operation current	Part No.	Weight
 <p>Filament lamp</p>			
12 VAC/DC	50 mA ±10 %	10-1209.1279	0.001 kg
12 VAC/DC	100 mA ±10 %	10-1209.1329	0.001 kg
24 VAC/DC	25 mA ±10 %	10-1212.1199	0.001 kg
24 VAC/DC	50 mA ±10 %	10-1212.1279	0.001 kg
28 VAC/DC	40 mA ±10 %	10-1213.1249	0.001 kg
30 VAC/DC	40 mA ±10 %	10-1214.1249	0.001 kg
36 VAC/DC	35 mA ±10 %	10-1216.1229	0.001 kg

Series resistor

Additional Information

- For filament lamp 48 VAC, 25 mA
- For lamp voltage reduction
- Keep to the country specific safety instructions
- Due to high surface temperatures, the series resistor must not be soldered directly to the terminals of the equipment (use a terminal plate)

Operating voltage	Resistance	Part No.	Weight
 <p>Series resistor</p>			
110 VAC	2.7 kOhm	02-904.0	0.003 kg
125 VAC	3.3 kOhm	02-904.1	0.003 kg
145 VAC	4.7 kOhm	02-904.3	0.003 kg
240 VAC	10 kOhm	02-904.7	0.003 kg

Terminal plate empty

Additional Information

- For fitting with series resistors

Product attribute	Dimension	Part No.	Weight
 <p>Terminal plate empty</p>			
5 spaces	62.5 x 60 x 15 mm	02-912.1	0.025 kg
10 spaces	125 x 60 x 15 mm	02-912.2	0.045 kg
15 spaces	187.6 x 60 x 15 mm	02-912.3	0.090 kg
20 spaces	250 x 60 x 15 mm	02-912.4	0.095 kg

02 Accessories

Mounting

Lens remover

Product attribute	Part No.	Weight
 Lens remover		
for flush front bezel	02-905	0.011 kg
 Lens remover		
for raised front bezel	98-968	0.004 kg

Lamp remover

Additional Information

▲ **Vorsicht:** A switching process might be released when replacing the lamp

Product attribute	Part No.	Weight
 Lamp remover		
for LED	03-996	0.027 kg
 Lamp remover		
for filament lamp	61-9740.0	0.003 kg

Actuator with snap-action switching element
Switching system

1 or 2 self-cleaning, snap-action switching elements.
1 or 2 double-throw contacts.

Material
Material of contact

Standard version:
Silver (U > 20V)
Special versions: (on request)
Gold/Silver 700Au/300Ag (U < 50V)
Silver/Palladium 700Ag/300Pd (U > 20V) for atmospheres containing sulphur

Switch housing

Thermosetting material, heat-resistant

Indicator housing with reduced length

Polyamide

Mechanical characteristics
Terminals

Screw terminal (with self-lifting clip):
max. wire cross-section, 2 x 2.5 mm²
max. wire cross-section of stranded cable, 2 x 1.5 mm²

Tightening torque

For fixing sleeve max. 20Ncm
For screw terminal max. 80Ncm

Actuating force

6N ... 12N

Actuating travel

5mm

Mechanical lifetime

Momentary action 2 million operations
Maintained action 1 million operations

Electrical characteristics
Standards

The switches comply with the "Standards for low-voltage switching devices" IEC 60947-5-1

Rated insulation voltage

400VAC/440VDC, as per IEC 60947-5-1

Conventional free air thermal current

10A

The maximum current in continuous operation and at ambient temperature not exceeding the quoted maximum values.

Switch rating

400VAC, 10A, cosφ 0.95, as per IEC 60947-5-1
250VAC, 10A, as per UL

Electric strength

2500VAC, 50Hz, 1 min. between all terminals and earth, as per IEC 60947-5-1

Environmental conditions
Storage temperature

-30°C ... +85°C

Service temperature

-25°C ... +55°C

For indicators and illuminated pushbuttons mounted as a block, make sure the heat can escape freely.

Protection degree

Front side IP 40, IP 65 with spray cover, as per IEC 60529

Shock resistance

15g for 11 ms, as per IEC 60068-2-27

Vibration resistance

10g at 10 ... 2000Hz, amplitude 1.0mm, as per IEC 60068-2-6

Approvals
Approbations

CB (IEC 60947-5-1)
CSA
Germanischer Lloyd
UL

Declaration of conformity

CE

02 Technical data

Buzzer

Buzzer system

System

Electronic non-contacting buzzer with IC oscillator

Material

Buzzer case

Thermosetting material

Front cap

Polycarbonate (PC)

Front bezel

Polymethylacrylate

Mechanical characteristics

Terminals

Screw terminal

Tightening torque

For fixing sleeve max. 20Ncm

For screw terminal max. 80Ncm

Electrical characteristics

Frequency (tone)

Approx. 2.8 kHz

Sound pressure

85 dB (A) ± 8 dB at a distance of 0.1 m

Volume variable with a M Ω potentiometer or corresponding fixed resistor

Operation Voltage/Current

typical

10 ... 55 VAC 10 ... 75 VDC

25 mA 15 mA

Environmental conditions

Storage temperature

-40 °C ... +85 °C

Operating temperature

-25 °C ... +55 °C

Protection degree

Front side IP 40, as per IEC 60529

Approvals

Approbations

CB (IEC 60947-5-1)

Declaration of conformity

CE

EAO reserves the right to alter specifications without further notice.

General notes

1. Engraving

In addition to the most commonly used world languages, in DIN1451-3 close spacing, other typefaces are available as Scandinavian, Slavic, Greek, Russian and Polish. Red, blue and black lenses are filled with white colour. Other colour lenses are filled in black. Standard height of letters is 3 mm. If the height is not specified, we will supply 3 mm engraved letters.

2. Hot stamping

For larger series it is worth considering markings by means of hot stamping. We will pleased to advise you. For letters and figures, typefaces with 2.5 mm, 3 mm and 4 mm are available.

3. Film inserts

Instead of using engraving the lenses can be fitted with transparent film inserts, as an alternative. For this purpose, though, it is advisable to use lenses without ripped pattern. In the case of use of a smoke-black lens the fitted film becomes readable only if the lamp is on. The film (F) is inserted in the cap. To ensure even illumination a diffusor (D) is recommended, which is inserted beneath the film. If, on the other hand, the diffusor is inserted above the film, the lettering only becomes legible when the lamp is alight. To hold the film and diffusor in position, the use of a holder (N) is advised. The film thickness is 0.2 mm.

All dimensions in mm

Film insert max. size	Height of letters h	Number of lines	Number of capital letters per line (target value)	Number of small letters per line (target value)	Image
14.3 x 22.4	3	4	11	13	B1
			7-8	8-9	B2
	4	2	7	9	B1
			4	5-6	B2
	5	2	5-6	6-7	B1
			3	4	B2
	6	1	5	6	B1
			3	4	B2
	8	1	3	4	B1
			2	2	B2



B1



B2



02 Application guidelines

Suppressor circuits

When switching inductive loads such as relays, DC motors, and DC solenoids, it is always important to absorb surges (e.g. with a diode) to protect the contacts. When these inductive loads are switched off, a counter emf can severely damage switch contacts and greatly shorten lifetime.

Fig. 1 shows an inductive load with a free-wheeling diode connected in parallel. This free-wheeling diode provides a path for the inductor current to flow when the current is interrupted by the switch. Without this free-wheeling diode, the voltage across the coil will be limited only by dielectric breakdown voltages of the circuit or parasitic elements of the coil. This voltage can be kilovolts in amplitude even when nominal circuit voltages are low (e.g. 12VDC) see Fig. 2.

The free-wheeling diode should be chosen so that the reverse breakdown voltage is greater than the voltage driving the inductive load. The DC blocking voltage (V_R) of the free-wheeling diode can be found in the datasheet of a diode. The forward current should be equal or greater than the maximum current flowing through the load.

To get an efficient protection, the free-wheeling diode must be connected as close as possible to the inductive load!

Switching with inductive load
Fig. 1



Counter EMF
over load without free-wheeling diode
Fig. 2



LED polarity

When fitting the LED element the polarity has to correspond with the respective terminal, (+) goes to +.



Index from Part No.

<u>Part No.</u>	<u>Page</u>	<u>Part No.</u>	<u>Page</u>
02-021.001	4	10-2K06.3159.....	18
02-070.001	4	10-2K09.1072.....	17
02-071.001	4	10-2K09.1074.....	17
02-072.001	4	10-2K09.1075.....	17
02-073.001	4	10-2K09.1076.....	17
02-198.011	10	10-2K09.1079.....	18
02-611.011	6	10-2K12.1072.....	17
02-611.011	8	10-2K12.1074.....	17
02-612.011	6	10-2K12.1075.....	17
02-612.011	8	10-2K12.1076.....	17
02-613.011	6	10-2K12.1079.....	18
02-613.011	8	10-2K13.1072.....	17
02-614.011	6	10-2K13.1074.....	17
02-614.011	8	10-2K13.1075.....	17
02-615.011	6	10-2K13.1076.....	17
02-615.011	8	10-2K13.1079.....	18
02-616.011	7	10-2K19.1052.....	17
02-617.011	7	10-2K19.1054.....	17
02-618.011	7	10-2K19.1055.....	17
02-619.011	7	10-2K19.1056.....	17
02-620.011	7	10-2K19.1059.....	18
02-690.011	9	22-925	13
02-691.011	9	61-9740.0	20
02-692.011	9	98-968	20
02-695.011	10		
02-810.001	5		
02-901.0	11		
02-901.1	11		
02-901.2	11		
02-901.3	11		
02-901.4	11		
02-901.5	11		
02-901.6	11		
02-901.7	11		
02-901.8	11		
02-901.9	11		
02-902.2	11		
02-902.5	11		
02-902.7	11		
02-904.0	18		
02-904.1	18		
02-904.3	18		
02-904.7	18		
02-905	20		
02-908.2	12		
02-908.3	12		
02-908.4	12		
02-908.5	12		
02-908.6	12		
02-908.7	12		
02-908.9	12		
02-909	12		
02-912.1	19		
02-912.2	19		
02-912.3	19		
02-912.4	19		
02-924	14		
02-929	16		
02-935	14		
02-949.0	15		
02-949.8	15		
02-965.0	13		
02-967.0	13		
02-980.1	12		
02-989.001	14		
03-996	20		
10-1209.1279	18		
10-1209.1329	18		
10-1212.1199	18		
10-1212.1279	18		
10-1213.1249	18		
10-1214.1249	18		
10-1216.1229	18		
10-2K06.3152.....	17		
10-2K06.3154.....	17		
10-2K06.3155.....	17		
10-2K06.3156.....	17		

