

ENK Series

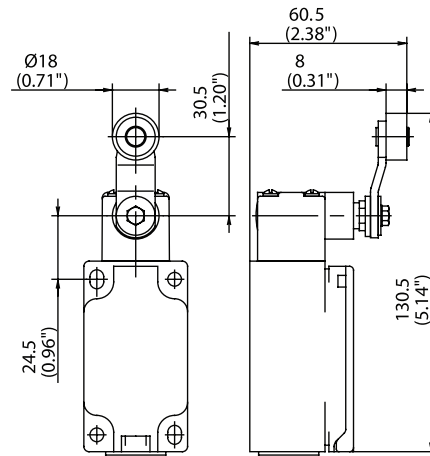

AHS-V (Form A)



AV

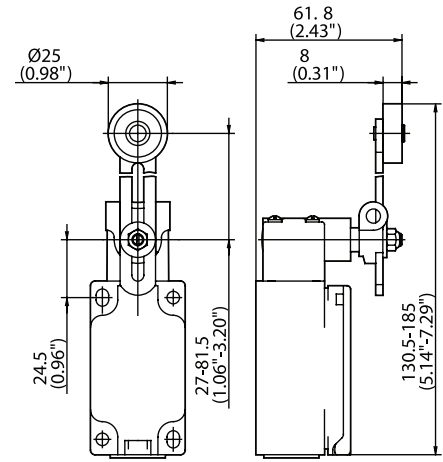

Switching Operation

1 NC / 1 NO Contacts

Slow Action

608.1135.003
ENK-U1Z AHS-V

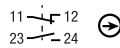

Snap Action

608.1185.009
ENK-SU1Z AHS-V

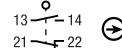

Slow Action

608.1136.012
ENK-U1 AV

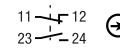

Snap Action

608.1186.018
ENK-SU1 AV

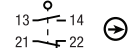

2 NC Contacts

608.1835.323
ENK-A2Z AHS-V

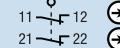

2 NO Contacts

1 NC / 1 NO Contacts Overlapping

608.1335.006
ENK-UV1Z AHS-V

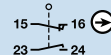

Replacement actuator:

391.8350.737

391.8360.738

Technical Information

	Slow Action	Snap Action
Maximum Switching Voltage	240V	240V
Max. Switching Amps (up to)*	10A	10A
B10d (up to)*	20 Million	20 Million
Mechanical Service Life (up to)*	3 x 10 ⁶	10 x 10 ⁵
Switching Frequency	≤ 100/min	≤ 100/min
Operating Temperature	-30 °C to +80 °C	-30 °C to +80 °C
Protection Rating	IP65	IP65
Utilization Category (up to)*	AC-15, Ue/Ue 240V 3A	AC-15, Ue/Ue 240V 3A
Rate Insulation Voltage	400VAC	400VAC

Approvals

* Depending on switching system - see technical information for details



Special features/variants (on request)

- Available with black enclosure
- With 50 mm diameter rubber roller
- 3 NC contacts possible

Special features/variants (on request)

- Available with different lever lengths
- With 50 mm diameter rubber roller

Drawing dimensions in mm