



GLK19264A-7T-1U

Including the GLK19264A-7T-1U-USB, and GLK19264A-7T-1U-422

Technical Manual

Revision 2.6

PCB Revision: 2.0 or Higher

Firmware Revision: 8.4 or Higher

Revision History

Revision	Date	Description	Author
2.6	January 2, 2018	Correction to Set Non-Standard Baud Rate command	Divino
2.5	October 27, 2015	Correction to Hardware Lock	Divino
2.4	October 19, 2015	Revision to Commands for Firmware Revision 8.6	Clark
2.3	May 21, 2014	Revision to Commands for Firmware Revision 8.5	Martino
2.2	March 5, 2014	Correction to Current Draw of Backlights	Martino
2.1	September 9, 2013	Corrected Scripted Key and Keypad Brightness Commands	Clark
2.0	July 10, 2013	Initial Release	Clark

Contents

1 Introduction	1
2 Quick Connect Guide.....	2
2.1 Available Headers	2
2.2 Standard Module	3
Recommended Parts.....	3
Serial Connections.....	3
I ² C Connections	4
2.3 USB Module	5
Recommended Parts.....	5
USB Connections.....	5
2.4 RS422 Module.....	6
RS422 Connections	6
3 Software	7
3.1 MOGD#	7
3.2 Firmware Upgrade	8
3.3 Application Notes.....	8
4 Hardware.....	9
4.1 Standard Model	9
Extended Communication/Power Header	9
Serial DB9 Connector	9
Power Through DB9 Jumper	10
Protocol Select Jumpers.....	10
Hardware Lock	10
4.2 USB Model.....	11
Mini USB Connector	11
Alternate USB Header	11
Alternate Power Connector	11
4.3 RS422 Model.....	12
RS422 Header.....	12
Alternate Power Connector	12

4.4 Common Features.....	13
General Purpose Outputs	13
Dallas One-Wire Connector	13
5 Troubleshooting.....	14
5.1 Power	14
5.2 Display.....	14
5.3 Communication.....	15
5.4 Manual Override	15
6 Commands	16
6.1 Communication.....	16
6.2 Text.....	18
6.3 Drawing.....	20
6.4 Fonts.....	25
Font File Creation.....	26
6.5 Bitmaps	27
Bitmap File Creation.....	29
Bitmap Masking	29
6.6 9-Slices	30
9-Slice File Creation.....	31
6.7 Animations	32
Animation File Creation	33
6.8 General Purpose Output.....	33
LED Indicators	34
6.9 Dallas One-Wire	34
6.10 Piezo Buzzer	35
6.11 Keypad.....	36
6.12 Display Functions	38
6.13 Scripting	40
6.14 Filesystem	40
File Transfer Protocol.....	43
XModem Transfer Protocol.....	44
6.15 Data Security.....	46

6.16 Miscellaneous	46
7 Appendix	48
7.1 Command Summary	48
7.2 Block Diagram	53
7.3 Environmental Specifications.....	53
7.4 Electrical Tolerances	53
7.5 Dimensional Drawings	54
7.1 Optical Characteristics	56
8 Ordering	56
8.1 Part Numbering Scheme	56
8.2 Options.....	56
8.3 Accessories.....	57
9 Definitions.....	59
10 Contact.....	59

1 Introduction



Figure 1: GLK19264A-7T-1U Display

The GLK19264A-7T-1U is an intelligent graphic liquid crystal display engineered to quickly and easily add an elegant creativity to any application. In addition to the RS232, TTL and I2C protocols available in the standard model, USB and RS422 communication models allow the GLK19264A-7T-1U to be connected to a wide variety of host controllers. Communication speeds of up to 115.2kbps for serial protocols and 100kbps for I²C ensure lightning fast text and graphic display.

The simple command structure permits easy software control of many settings including backlight brightness, screen contrast, and baud rate. On board memory provides a whopping 256KB of customizable fonts and bitmaps to enhance the graphical user experience.

User input on the GLK19264A-7T-1U is available through a built-in seven key tactile keypad. Three bi-colour LEDs provide visual outputs and six general purpose outputs provide simple switchable five volt sources on each model. In addition, an optional Dallas One-Wire header provides a communication interface for up to thirty-two devices.

The versatile GLK19264A-7T-1U, with all the features mentioned above, is available in a variety of colour, voltage, and temperature options to suit almost any application.

2 Quick Connect Guide

2.1 Available Headers

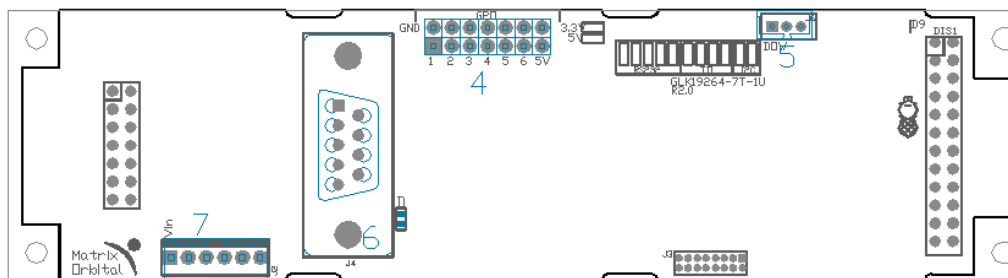

Figure 2: GLK19264A-7T-1U Standard Module Header Locations

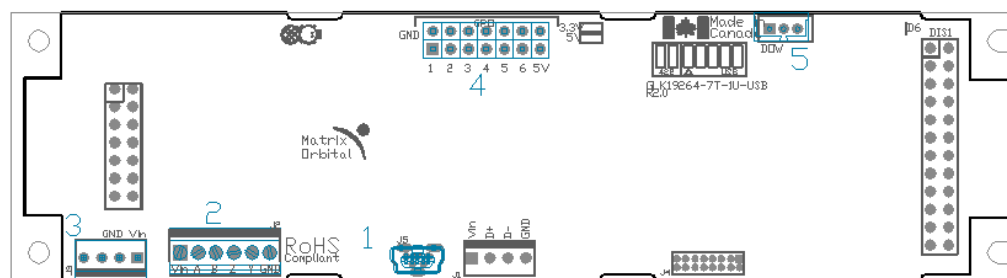

Figure 3: GLK19264A-7T-1U USB and RS422 Model Header Locations

Table 1: List of Available Headers

#	Header	Mate	Population
1	Mini USB Connector	EXTMUSB3FT/INTMUSB3FT	USB Model Only
2	RS422 Terminal Block	16-30 AWG Wire	422 Model Only
3	Alternate Power Connector	PCS	422 and USB Models Only
4	GPO Header	None Offered	All Models
5	Optional Dallas One-Wire Header	Temperature Probe	USB Model Only
6	DB9 Serial Header	CSS1FT/CSS4FT	Standard Model Only
7	Extended Communication/Power Connector	ESCCPC5V/BBC	Standard Model Only



2.2 Standard Module

The standard version of the GLK19264A-7T-1U allows for user configuration of two common communication protocols. First, the unit can communicate using serial protocol at either RS232 or TTL voltage levels. Second, it can communicate using the Inter-Integrated Circuit connect, or I²C protocol. Connections for each protocol can be accessed through the four pin Communication/Power Header as outlined in the Serial Connections and I²C Connections sections below.

Recommended Parts



Figure 4: Extended Communication/Power Cable (ESCCPC5V)

The most common cable choice for any standard Matrix Orbital display, the Extended Communication/ Power Cable offers a simple connection to the unit with familiar interfaces. DB9 and floppy power headers provide all necessary input to drive your display.



Figure 5: Breadboard Cable (BBC)

For a more flexible interface to the GLK19264A-7T-1U, a Breadboard Cable may be used. This provides a simple four wire connection that is popular among developers for its ease of use in a breadboard environment.

Serial Connections

Serial protocol provides a classic connection to the GLK19264A-7T-1U. The Extended Communication/Power Cable is most commonly used for this set up as it provides connections for DB9 serial and floppy power cables. To place your board in Serial mode, adhere to the steps laid out below.

1. Set the Protocol Select jumpers.
 - RS232: Connect the five jumpers* in the 232 protocol box with the zero ohm jumper resistors provided or an alternate wire or solder solution.
 - TTL: Connect the four jumpers* in the TTL protocol box.

***Note:** Jumpers must be removed from all protocol boxes save for the one in use.

2. Make the connections.
 - a. Connect the six pin female header of the Extended Communication/Power Cable to the Communication/Power Header of your GLK19264A-7T-1U.
 - b. Insert the male end of your serial cable to the corresponding DB9 header of the Extended Communication/Power Cable and mate the female connector with the desired communication port of your computer.
 - c. Select an unmodified floppy cable from a PC power supply and connect it to the power header of the Communication/Power Cable.
3. Create.
 - MOGD# or a terminal program will serve to get you started, and then you can move on with your own development. Instructions for the former can be found below and a variety of application notes are available for the latter at www.matrixorbital.ca/appnotes.

I²C Connections

A more advanced connection to the GLK19264A-7T-1U is provided by the I²C protocol setting. This is best accomplished using a breadboard and the Breadboard Cable. Power must be supplied from your breadboard or another external source. To dive right into your application and use the GLK19264A-7T-1U in I²C mode, get started with the guidelines below.

1. Set the Protocol Select switches.
 - I²C: Ensure that the two I²C jumpers in the corresponding protocol box are connected while all others are open.
2. Make the connections.
 - a. Connect the Breadboard Cable to the Communication/Power Header on your GLK19264A-7T-1U and plug the four leads into your breadboard. The red lead will require power, while the black should be connected to ground, and the green and yellow should be connected to your controller clock and data lines respectively.
 - b. Pull up the clock and data lines to five volts using a resistance between one and ten kilohms on your breadboard.
3. Create.
 - This time you're on your own. While there are many examples within the Matrix Orbital AppNote section, www.matrixorbital.ca/appnotes, too many controllers and languages exist to cover them all. If you get stuck in development, it is possible to switch over to another protocol on the standard board, and fellow developers are always on our forums for additional support.



2.3 USB Module

The GLK19264A-7T-1U-USB offers a single USB protocol for easy connection to a host computer. The simple and widely available protocol can be accessed using the on board mini B style USB connector as outlined in the USB Connections section.

Recommended Parts



Figure 6: Mini USB Cable
(EXTMUSB3FT)

The External Mini USB cable is recommended for the GLK19264A-7T-1U-USB display. It will connect to the miniB style header on the unit and provide a connection to a regular A style USB connector, commonly found on a PC.

USB Connections

The USB connection is the quickest, easiest solution for PC development. After driver installation, the GLK19264A-7T-1U-USB will be accessible through a virtual serial port, providing the same result as a serial setup without the cable hassle. To connect to your GLK19264A-7T-1U-USB please follow the steps below.

1. Set the Protocol Select jumpers.
 - USB: The GLK19264A-7T-1U-USB offers USB protocol only. Model specific hardware prevents this unit from operating in any other protocol, and does not allow other models to operate in USB. Protocol Select jumpers on the USB model cannot be moved.
2. Make the connections.
 - Plug the mini-B header of your External Mini USB cable into your GLK19264A-7T-1U-USB and the regular USB header into your computer USB jack.
3. Install the drivers.
 - a. Download the latest drivers at www.matrixorbital.ca/drivers, and save them to a known location.
 - b. When prompted, install the USB bus controller driver automatically
 - c. If asked, continue anyway, even though the driver is not signed
 - d. When the driver install is complete, your display will turn on, but communication will not yet be possible.
 - e. At the second driver prompt, install the serial port driver automatically
 - f. Again, if asked, continue anyway
4. Create.
 - Use MOGD# or a terminal program to get started, and then move on with your own development. Instructions for the former can be found below and a number of application notes are available for the latter at www.matrixorbital.ca/appnotes.



2.4 RS422 Module

The GLK19264A-7T-1U-422 provides an industrial alternative to the standard RS232 communication protocol. Rather than single receive and transmit lines, the RS422 model uses a differential pair for the receive and transmit signals to reduce degradation and increase transmission lengths. Power can be transmitted at distance to a -VPT module or supplied from the immediate vicinity to a regular or -LV unit. RS422 signals are available in a six pin connector as described in the RS422 Connections section.

RS422 Connections

The GLK19264A-7T-1U-422 provides a robust RS422 interface to the display line. For this interface, a series of six wires are usually screwed into the RS422 terminal block provided. An alternate header is also available to provide local power to a regular or -LV unit. To connect to your GLK19264A-7T-1U-422, adhere to the steps laid out below.

1. Set the Protocol Select jumpers.
 - RS422: The GLK19264A-7T-1U-422 offers only RS422 protocol and does not require any jumper changes.
2. Make the connections.
 - a. Screw one wire; sized 16 to 30 on the American Wire Gauge, into each of the six terminal block positions. When local power is supplied, a floppy cable may link to the alternate power header.
 - b. Connect the Vcc wire to the positive terminal of your power supply and the GND terminal to the negative or ground lead to provide appropriate power as per Voltage Specifications.
 - c. Secure the A and B wires to your non-inverting and inverting output signals respectively, while attaching the Z and Y wires to your inverting and non-inverting inputs.
3. Create.
 - a. In a PC environment, MOGD# or a terminal program will serve to get you started. In addition, a variety of application notes are available online in a number of different languages to aid in the development of a host controller. Instructions for these programs can be found below and the simple C# example at www.matrixorbital.ca/appnotes is a great first programming reference.



3 Software

The multiple communication protocols available and simple command structure of the GLK19264A-7T-1U means that a variety of applications can be used to communicate with the display. Text is sent to the display as a character string, for example, sending the decimal value 41 will result in an 'A' appearing on the screen. A single control character is also available. Commands are merely values prefixed with a special command byte, 254 in decimal.

Table 2: Reserved Control Characters

Control Characters			
7	Bell / Sound Buzzer	10	Line feed / New line

Once the correct communication port is identified, the following communication settings can be applied to communicate correctly with the GLK19264A-7T-1U.

Table 3: Communication Settings

BPS	Data Bits	Parity	Stop Bits	Flow Control
19200	8	None	1	None

Finally, with a communication port identified and correctly setup simple text strings or even command bytes can easily be transmitted to control your display.

3.1 MOGD#

The Matrix Orbital Graphic Display interface, MOGD#, is offered as a free download from www.matrixorbital.ca/software/software_graphic. It provides a simple graphical interface that allows settings, fonts, and bitmaps to be easily customised for any application.

While monochromatic bitmaps can easily be created in virtually any image editing program, MOGD# provides an extensive font generation suite to stylize your display to any project design. In addition to standard font wide modifications, character ranges can be specified by start and end values to eliminate unused symbols, and individual glyphs can be modified with a double click. Finally, text spacing can be tailored and a complete font library built with your Matrix Orbital graphic display.

Like uProject, MOGD# offers a scripting capability that provides the ability to stack, run, and save a series of commands. The most basic function is the Send Numeric tool which is used to transmit a string of values to the display to write text or execute a command.





Figure 7: MOGD# Command Example

Again, the clear screen command is sent to a connected display, this time using the MOGD# Send Numeric function command style. Scripts can be run as a whole using the Play button from the toolbar or as single commands by selecting Step; once executed it must be Reset. Before issuing commands, it is a good idea to ensure communication with a display is successful using the autodetect button.

This program provides both a staging areas for your graphics display and a proving ground that will prepare it for any application environment.

3.2 Firmware Upgrade

Beginning with revision 8.1, the firmware of the GLK19264A-7T-1U can be upgraded in the field. All firmware revisions can be installed using software found at www.matrixorbital.ca/software/GLT Series.

If it is necessary to forgo all current and future upgrades to the filesystem and subsequent commands, firmware revision 8.0 may be ordered as a part of a custom order. Please use the Contact section to request more information from the Matrix Orbital sales team.

3.3 Application Notes

Full demonstration programs and code are available for Matrix Orbital displays in the C# language from Simple C# AppNote Pack in the Application Note section at www.matrixorbital.ca/appnotes. Difficulty increases from beginner, with the Hello World program, to advanced with the Dallas One-Wire temperature reading application.

Many additional applications are available in a number of different programming languages. These programs are meant to showcase the capability of the display and are not intended to be integrated into a final design. For additional information regarding code, please read the On Code document also found on the support site.



4 Hardware

4.1 Standard Model

Extended Communication/Power Header

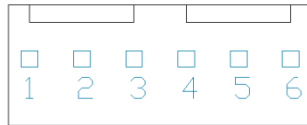

Figure 8: Extended Communication/Power Header

Table 4: Extended Communication/Power Pinout

Pin	Function
1	Vcc
2	Rx (SCL)
3	Tx (SDA)
4	Gnd
5	CTS
6	RTS

The Extended Communication/Power Header provides a standard connector for interfacing to the GLK19264A-7T-1U. Voltage is applied through pins one and four of the four pin Communication/Power Header. Please ensure the correct voltage input for your display by referencing Voltage Specifications before connecting power. Pins two and three are reserved for serial transmission, using either the RS-232/TTL or clocking data through the I²C protocol, depending on what has been selected by the Protocol Select Jumpers. Pins five and six can be used for serial transmission hardware flow control, and are ignored for I²C communications. The Molex 22-04-1061 style header used can be mated to a number of connectors, a 22-01-1062 for example.

Serial DB9 Connector

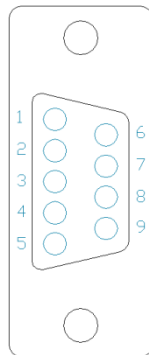

Figure 9: Serial DB9 Connector

Table 5: Serial DB9 Pinout

Pin	Function
2	Tx
3	Rx
5	Gnd
7	CTS
8	RTS
9	NC/Vcc*

The GLK19264A-7T-1U provides a DB-9 Connector to readily interface with serial devices using EIA232 standard signal levels. It is also possible to communicate at TTL levels of 0 to +5V by setting the Protocol Select Jumpers to TTL. As an added feature it is also possible to apply power through pin 9 of the DB-9 Connector in order to reduce cable clutter. A standard male DB9 header will provide the perfect mate for this connector.

***Note:** Do not apply voltage through pin 9 of the DB-9 Connector AND through the Communication/Power Header at the same time.



Power Through DB9 Jumper

In order to provide power through pin 9 of the DB-9 Connector you must connect the Power Through DB-9 Jumper labelled D, as illustrated below. This connection can be made using a zero ohm resistor, recommended size 0603, or a solder bridge. The GLK19264A-7T-1U allows all voltage models to use the power through DB-9 option, see the Voltage Specifications for power requirements.

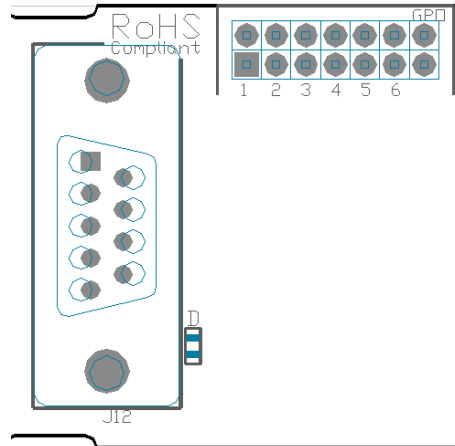

Figure 10: Power Through DB9 Jumper

Protocol Select Jumpers

The Protocol Select Jumpers provide the means necessary to toggle the GLK19264A-7T-1U between RS-232, TTL and I²C protocols. As a default, the jumpers are set to RS-232 mode with solder jumps on the RS232 jumpers. In order to place the display module in I²C mode you must first remove the solder jumps from the RS232 jumpers and then place them on the I²C jumpers. The display will now be in I²C mode and have a default slave address of 80, unless changed with the appropriate command. Similarly, in order to change the display to TTL mode, simply remove the zero ohm resistors from the RS232 or I²C jumpers and solder them to the TTL jumpers.

Hardware Lock

The Hardware Lock allows fonts, bitmaps, and settings to be saved, unaltered by any commands. By connecting the two pads near the memory chip, designated R74, with a zero ohm resistor, the display will be locked. This supersedes the data lock command and cannot be circumvented by any software means. To unlock the display and make changes simply remove the jumper.



4.2 USB Model

Mini USB Connector

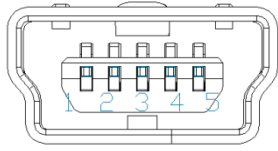

Figure 11: Mini USB Connector

Table 6: Mini USB Pinout

Pin	Function
1	Vcc
2	D-
3	D+
5	Gnd

The GLK19264A-7T-1U-USB comes with a familiar Mini USB Connector to fulfill both communication and power needs. The standard Mini-B style header can be connected to any other USB style using the appropriate cable. Most commonly used with a PC, this connection creates a virtual com port that offers a simple power solution with a familiar communication scheme.

Alternate USB Header

Some advanced applications may prefer the straight four pin connection offered through the Optional Alternate USB Header. This header offers power and communication access in a simple interface package. The Optional Alternate USB Header may be added to the GLK19264A-7T-1U-USB for an added charge as part of a custom order. Please use the Contact section to request more information from the friendly Matrix Orbital sales team.

Alternate Power Connector

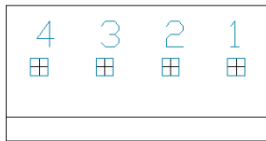

Figure 12: Alternate Power Connector

Table 7: Alternate Power Pinout

Pin	Function
1	Vcc
2	Gnd
3	Gnd
4	NC

The Alternate Power Connector provides the ability to power the GLK19264A-7T-1U-USB using a second cable. The Tyco 171825-4 style header is particularly useful for connecting to an unmodified floppy power cable, a 171822-4 for example, from a PC power supply for a simple bench power solution.



4.3 RS422 Model

RS422 Header

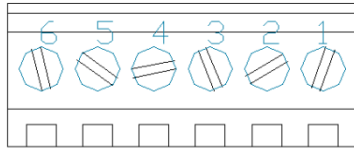

Figure 13: RS422 Header

Table 8: RS422 Pinout

Pin	Function
1	Gnd
2	Rx (Y)
3	Inv Rx (Z)
4	Inv Tx (B)
5	Tx (A)
6	Vcc

The six pin RS422 interface header of the GLK19264A-7T-1U-422 offers power and ground connections as well as two differential pair communication lines. Regular and inverted lines are provided for both receive and transmit signals. Power is supplied locally to the regular or –LV variants while the –VPT can receive power over a distance. The Tyco 282834-6 style header is most suited to a simple wire connection.

Alternate Power Connector

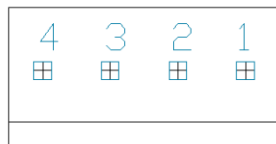

Figure 14: Alternate Power Connector

Table 9: Alternate Power Pinout

Pin	Function
1	Vcc
2	Gnd
3	Gnd
4	NC

The Alternate Power Connector provides the ability to power the GLK19264A-7T-1U-USB using a second cable. The Tyco 171825-4 style header is particularly useful for connecting to an unmodified floppy power cable, a 171822-4 for example, from a PC power supply for a simple bench power solution.



4.4 Common Features

General Purpose Outputs

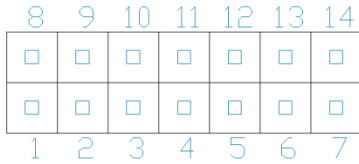

Figure 15: GPO Header

Table 10: GPO Pinout

Pin	Function	Pin	Function
1	GPO 1	8	Gnd
2	GPO 2	9	Gnd
3	GPO 3	10	Gnd
4	GPO 4	11	Gnd
5	GPO 5	12	Gnd
6	GPO 6	13	Gnd
7	Vcc	14	Gnd

A unique feature of the GLK19264A-7T-1U is the ability to control relays* and other external devices using either one or six General Purpose Outputs. Each can source up to 10mA of current at five volts when on or sink 20mA at zero volts when off. The two row, fourteen pin header can be interfaced to a number of female connectors to provide control to any peripheral devices required.

***Note:** If connecting a relay, be sure that it is fully clamped using a diode and capacitor in order to absorb any electro-motive force (EMF) which will be generated.

Dallas One-Wire Connector

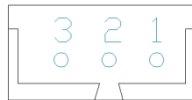

Figure 16: Dallas One-Wire Connector

Table 11: Dallas One-Wire Pinout

Pin	Function
1	Vcc
2	D
3	Gnd

In addition to the six general purpose outputs the GLK19264A-7T-1U offers an Optional Dallas One-Wire bridge, to allow for an additional thirty two one-wire devices to be connected to the display. This header can be populated with a Tyco 173979 connector at an added cost by custom order only. Please use the Contact section to request more information from the Matrix Orbital sales team.



5 Troubleshooting

5.1 Power

In order for your Matrix Orbital display to function correctly, it must be supplied with the appropriate power. If the power LED near the top right corner of the board is not illuminated, power is not applied correctly. Try following the tips below.

- First, check the power cable which you are using for continuity. If you don't have an ohm meter, try using a different power cable, if this does not help try using a different power supply.
- If power is applied through the DB9 connector, ensure that the Power Through DB9 Jumper is connected.
- If changes have been made to the protocol select block, ensure all the appropriate protocol select jumpers are connected and all unused protocol jumpers are disconnected.
- The last step will be to check the interface connector in use on your display. If the power connections have become loose, or you are unable to resolve the issue, please Contact Matrix Orbital for more information.

5.2 Display

If your display is powered successfully, the Matrix Orbital logo, or user created screen should display on start up. If this is not the case, check out these tips.

- Ensure the contrast is not too high or too low. This can result in a darkened or blank screen respectively. See the Manual Override section to reset to default.
- Make sure that the start screen is not blank. It is possible to overwrite the Matrix Orbital logo start screen, if this happens the screen may be blank. Try writing to the display to ensure it is functional, after checking the contrast above.



5.3 Communication

When communication of either text or commands is interrupted, try the steps below.

- First, check the communication cable for continuity. If you don't have an ohm meter, try using a different communication cable. If you are using a PC try using a different Com/USB Port.
- Next, please ensure that the display module is set to communicate on the protocol that you are using, by checking the Protocol Select Jumpers.
- In serial and USB protocols, ensure that the host system and display module are both communicating on the same baud rate. The default rate for the display module is 19200 bps.
- Match Rx from your display to the transmitting pin from your host and the Tx pin to the receiving pin.
- If you are communicating to the display via I²C* please ensure that the data is being sent to the correct address. The default slave address for the display module is 80.
- In I²C mode, connect Rx to the clock line of your controller and Tx to the data output.
- Unlock the display. See the Set and Save Data Lock command for more info.
- Finally, you may reset the display to its default settings using the Manual Override procedure outlined below.

***Note:** I²C communication will always require pull up resistors on SCL and SDA of one to ten kilohms.

5.4 Manual Override

Should the settings of your display become altered in a way that dramatically impacts usability, the default settings can be temporarily restored. To override the display, please follow the steps below.

1. Disconnect power from your display.
2. Hold down the bottom left dot key.
3. Reconnect power to your unit, and wait for the start screen before releasing the key.
4. Settings will be temporarily** overridden to the defaults listed in the Manual Override Settings table. At this point any important settings, such as contrast, backlight, or baud rate, should not only be set but saved so they remain when the override is removed.

Parameter	Value
Backlight	255
Contrast	128
Baud Rate	19200
I ² C Address	80

Table 12: Manual Override Settings

****Note:** The display module will revert back to the old settings once turned off, unless desired settings are saved.



6 Commands

6.1 Communication

1.1 Change Baud Rate	Dec	254 57	Speed	v8.0
	Hex	FE 39	Speed	
	ASCII	■ 9	Speed	
Immediately changes the baud rate. Not available in I2C. Baud rate can be temporarily forced to 19200 by a manual override.				
Speed	Byte	Valid settings shown below.		

Table 13: Accepted Baud Rate Values

Rate	9600	14400	19200	28800	38400	57600	76800	115200
Speed	207	138	103	68	51	34	25	16

1.2 Change I2C Slave Address	Dec	254 51	Address	v8.0
	Hex	FE 33	Address	
	ASCII	■ 3	Address	
Immediately changes the I2C write address. Only even values are permitted as the next odd address will become the read address. Default is 80.				
Address	Byte	Even value.		

1.3 Transmission Protocol Select	Dec	254 160	Protocol	v8.0
	Hex	FE A0	Protocol	
		■ á	Protocol	
Selects the protocol used for data transmission from the display. Data transmission to the display is not affected. Must be set to the protocol in use to receive data correctly.				
Protocol	Byte	1 for Serial (RS232/RS422/TTL/USB) or 0 for I2C.		

1.4 Set a Non-Standard Baud Rate	Dec	254 164	Baud	v5.0
	Hex	FE A4	Baud	
	ASCII	■ ñ	Baud	
Immediately changes the baud rate to the value specified. Baud must be a whole number between 0 and 1,000,000. Not available in I2C. Can be temporarily forced to 19200 by a manual override.				
Baud	Integer	Baud rate speed. The value must be sent using little endian format.		
*Note: Command was restructured at firmware revision 8.0				

1.5 Set Flow Control Mode	Dec	254 63	Mode	v8.0
	Hex	FE 3F	Mode	
	ASCII	■ ?	Mode	
Toggles flow control between hardware, software and off settings. Software and Hardware control can be further tuned using the settings above. Default is Off, or 0.				
Mode	Byte	Flow control setting as below.		

Table 14: Hardware Flow Control Trigger Levels

Bytes	1	4	8	14
Level	0	1	2	3

Table 15: Flow Control Settings

Flow Control	None	Software	Hardware
Mode	0	1	2



1.6 Set Hardware Flow Control Trigger Level	Dec	254 62	Level	v8.0
	Hex	FE 3E	Level	
	ASCII	■ >	Level	
Sets the hardware flow control trigger level. The Clear To Send signal will be deactivated once the number of characters in the display buffer reaches the level set; it will be reactivated once all data in the buffer is handled.				
Level	Byte	Trigger level as above.		

1.7 Turn Software Flow Control On	Dec	254 58	Almost Full	Almost Empty	v8.0
	Hex	FE 3A	Almost Full	Almost Empty	
	ASCII	■ :	Almost Full	Almost Empty	
Enables simple flow control. The display will return a single, Xoff, byte to the host when the display buffer is almost full and a different, Xon, byte when the buffer is almost empty. Full value should provide enough room for the largest data packet to be received without buffer overflow. No data should be sent to the display between full and empty responses to permit processing. Buffer size is 256* bytes. Not available in I ² C. Default off.					
Almost Full	Byte	Number of bytes remaining before buffer is completely full, 0 < Full < Empty < 256*.			
Almost Empty	Byte	Number of bytes before buffer can be considered empty enough to accept data.			
*Note: Buffer size was increased to 256 bytes from 128 bytes at firmware revision 8.3.					

1.8 Turn Software Flow Control Off	Dec	254 59		v8.0
	Hex	FE 3B		
	ASCII	■ ;		
Disables flow control. Bytes sent to the display may be permitted to overflow the buffer resulting in data loss.				

1.9 Set Software Flow Control Response	Dec	254 60	Xon	Xoff	v8.0
	Hex	FE 3C	Xon	Xoff	
	ASCII	■ <	Xon	Xoff	
Sets the values returned for almost full and almost empty messages when in flow control mode. This command permits the display to utilize standard flow control values of 0x11 and 0x13, note that defaults are 0xFF and 0xFE.					
Xon	Byte	Value returned when display buffer is almost empty, permitting transmission to resume.			
Xoff	Byte	Value returned when display buffer is almost full, signaling transmission to halt.			

1.10 Echo	Dec	254 255	Length	Data	v8.3
	Hex	FE FF	Length	Data	
	ASCII	■	Length	Data	
Send data to the display that it will echo. Useful to confirm communication or return information from scripts.					
Length	Short	Length of data array to be echoed.			
Data	Byte(s)	An arbitrary array of data that the module will return.			
Response	Byte(s)	The same arbitrary array of data originally sent.			

1.11 Delay	Dec	254 251	Time	v8.3
	Hex	FE FB	Time	
	ASCII	■ v	Time	
Pause command execution to and responses from the display for the specified length of time.				
Time	Short	Length of delay in ms, maximum 2000.		



1.12 Software Reset	Dec	254 253 77 79 117 110	v8.4
	Hex	FE FD 4D 4F 75 6E	
	ASCII	■ ²M O u n	
Reset the display as if power had been cycled via a software command. No commands should be sent while the unit is in the process of resetting; a response will be returned to indicate the unit has successfully been reset.			
Response	Short	Successful reset response, 254 212.	

6.2 Text

2.1 Clear Screen	Dec	254 88	v8.0
	Hex	FE 58	
	ASCII	■ X	
Clears the contents of the screen.			

2.2 Go Home	Dec	254 72	v8.0
	Hex	FE 48	
	ASCII	■ H	
Returns the cursor to the top left of the screen.			

2.3 Set Cursor Position	Dec	254 71	Column Row	v8.0
	Hex	FE 47	Column Row	
	ASCII	■ G	Column Row	
Sets the cursor to a specific cursor position where the next transmitted character is printed.				
Column	Byte	Value between 1 and number of character columns.		
Row	Byte	Value between 1 and number of character rows.		

2.4 Set Cursor Coordinate	Dec	254 121	X Y	v8.0
	Hex	FE 79	X Y	
	ASCII	■ y	X Y	
Sets the cursor to an exact pixel position where the next transmitted character is printed.				
X	Byte	Value between 1 and screen width, represents leftmost character position.		
Y	Byte	Value between 1 and screen height, represents topmost character position.		

2.5 Get String Extents	Dec	254 41	Text	v8.6
	Hex	FE 29	Text	
	ASCII	■)	Text	
Read the size of the rectangle that the specified string would occupy if it was rendered with the current font.				
Text	String	String on which to preform extents calculation. A single line of text is assumed.		
Response	Byte(s)	Width and height of the string in pixels. A width greater than the screen will return 0.		



2.6 Initialize Text Window	Dec	254 43	ID X1 Y1 X2 Y2 Font CharSpace LineSpace Scroll	v8.3
	Hex	FE 2B	ID X1 Y1 X2 Y2 Font CharSpace LineSpace Scroll	
	ASCII	■ +	ID X1 Y1 X2 Y2 Font CharSpace LineSpace Scroll	

Designates a portion of the screen to which text can be confined. Font commands affect only the current window, default (entire screen) is window 0.

ID	Byte	Unique text window identification number, value between 0 and 15.
X1	Byte	Leftmost coordinate.
Y1	Byte	Topmost coordinate.
X2	Byte	Rightmost coordinate.
Y2	Byte	Bottommost coordinate.
Font*	Short	Unique font ID to use for this window, value between 0 and 1023.
CharSpace	Byte	Spacing between characters to use for this window.
LineSpace	Byte	Spacing between lines to use for this window.
Scroll	Byte	Number of pixel rows to write to before scrolling text.

***Note:** Font was changed from a Byte length at firmware revision 8.5

2.7 Set Text Window	Dec	254 42	ID	v8.3
	Hex	FE 2A	ID	
	ASCII	■ *	ID	

Sets the text window to which subsequent text and commands will apply. Default (entire screen) is window 0.

ID	Byte	Unique text window to use.
-----------	-------------	----------------------------

2.8 Clear Text Window	Dec	254 44	ID	v8.3
	Hex	FE 2C	ID	
	ASCII	■ ,	ID	

Clear the contents of a specific text window, similar to the clear screen command.

ID	Byte	Unique text window to clear.
-----------	-------------	------------------------------

2.9 Initialize Label	Dec	254 45	ID X1 Y1 X2 Y2 Vert Hor Font Background CharSpace	v8.3
	Hex	FE 2D	ID X1 Y1 X2 Y2 Vert Hor Font Background CharSpace	
	ASCII	■ -	ID X1 Y1 X2 Y2 Vert Hor Font Background CharSpace	

Designates a portion of the screen that can be easily updated with one line of text, often used to display variables.

ID	Byte	Unique label identification number, value between 0 and 15.
X1	Byte	Leftmost coordinate.
Y1	Byte	Topmost coordinate.
X2	Byte	Rightmost coordinate.
Y2	Byte	Bottommost coordinate.
Vert	Byte	Vertical justification of the label text; 0 for top, 1 for middle, or 2 for bottom.
Hor	Byte	Horizontal justification of the label text; 0 for left, 1 for centre, or 2 for right.
Font*	Short	Unique font ID to use for this label, value between 0 and 1023.
Background	Byte	State of the pixels in the label region that is not occupied by text; 0 for off or 1 for on.
CharSpace	Byte	Spacing between characters to use for this label.

***Note:** Font was changed from a Byte length at firmware revision 8.5



2.10 Initialize Scrolling Label	Dec	254 47	ID X1 Y1 X2 Y2 Vert Dir Font Background CharSpace Delay	v8.6
	Hex	FE 2F	ID X1 Y1 X2 Y2 Vert Dir Font Background CharSpace Delay	
	ASCII	■ /	ID X1 Y1 X2 Y2 Vert Dir Font Background CharSpace Delay	

Designates a portion of the screen that can be easily updated with one line of text, often used to display variables.

ID	Byte	Unique label identification number, value between 0 and 15.
X1	Byte	Leftmost coordinate.
Y1	Byte	Topmost coordinate.
X2	Byte	Rightmost coordinate.
Y2	Byte	Bottommost coordinate.
Vert	Byte	Vertical justification of the label text; 0 for top, 1 for middle, or 2 for bottom.
Dir	Byte	Direction of the scrolling behavior; 0 for left, 1 for right, or 2 for bounce.
Font	Short	Unique font ID to use for this label, value between 0 and 1023.
Background	Byte	State of the pixels in the label region that is not occupied by text; 0 for off or 1 for on.
CharSpace	Byte	Spacing between characters to use for this label.
Delay	Short	Time in milliseconds to elapse between characters printed.

2.11 Update Label	Dec	254 46	ID Data	v8.3
	Hex	FE 2E	ID Data	
	ASCII	■ .	ID Data	

Update a previously created label or scrolling label with new text. Send a null character (empty string) to clear.

ID	Byte	Unique label to update, value between 0 and 15.
Data	String	Information to display in the label, must be terminated with a null (value of zero) byte.

2.12 Auto Scroll On	Dec	254 81	v8.0
	Hex	FE 51	
	ASCII	■ Q	

The entire contents of screen are shifted up one line when the end of the screen is reached. Display default is on.

2.13 Auto Scroll Off	Dec	254 82	v8.0
	Hex	FE 52	
	ASCII	■ R	

New text is written over the top line when the end of the screen is reached. Display default is Auto Scroll on.

6.3 Drawing

3.1 Set Drawing Colour	Dec	254 99	Colour	v8.0
	Hex	FE 63	Colour	
	ASCII	■ c	Colour	

Set the colour to be used for all future drawing commands that do not implicitly specify colour.

Colour	Byte	0 for background or any other value for text colour.
---------------	-------------	--



3.2 Draw a Pixel	Dec	254 112	X Y	v8.0
	Hex	FE 70	X Y	
	ASCII	■ p	X Y	
Draw a single pixel at the specified coordinate using the current drawing colour.				
X	Byte	Horizontal position of pixel to be drawn.		
Y	Byte	Vertical position of pixel to be drawn.		

3.3 Draw a Line	Dec	254 108	X1 Y1 X2 Y2	v8.0
	Hex	FE 6C	X1 Y1 X2 Y2	
	ASCII	■ l	X1 Y1 X2 Y2	
Draw a line connecting two termini. Lines may be rendered differently when drawn right to left versus left to right.				
X1	Byte	Horizontal coordinate of first terminus.		
Y1	Byte	Vertical coordinate of first terminus.		
X2	Byte	Horizontal coordinate of second terminus.		
Y2	Byte	Vertical coordinate of second terminus.		

3.4 Continue a Line	Dec	254 101	X Y	v8.0
	Hex	FE 65	X Y	
	ASCII	■ e	X Y	
Draw a line from the last point drawn to the coordinate specified using the current drawing colour.				
X	Byte	Left coordinate of terminus.		
Y	Byte	Top coordinate of terminus.		

3.5 Draw a Rectangle	Dec	254 114	Colour X1 Y1 X2 Y2	v8.0
	Hex	FE 72	Colour X1 Y1 X2 Y2	
	ASCII	■ r	Colour X1 Y1 X2 Y2	
Draw a rectangular frame one pixel wide using the colour specified; current drawing colour is ignored.				
Colour	Byte	0 for background or any other value for text colour.		
X1	Byte	Leftmost coordinate.		
Y1	Byte	Topmost coordinate.		
X2	Byte	Rightmost coordinate.		
Y2	Byte	Bottommost coordinate.		

3.6 Draw a Filled Rectangle	Dec	254 120	Colour X1 Y1 X2 Y2	v8.0
	Hex	FE 78	Colour X1 Y1 X2 Y2	
	ASCII	■ x	Colour X1 Y1 X2 Y2	
Draw a filled rectangle using the colour specified; current drawing colour is ignored.				
Colour	Byte	0 for background or any other value for text colour.		
X1	Byte	Leftmost coordinate.		
Y1	Byte	Topmost coordinate.		
X2	Byte	Rightmost coordinate.		
Y2	Byte	Bottommost coordinate.		



3.7 Draw a Rounded Rectangle	Dec	254 128	X1 Y1 X2 Y2 Radius	v8.3
	Hex	FE 80	X1 Y1 X2 Y2 Radius	
	ASCII	■ Ç	X1 Y1 X2 Y2 Radius	
Draw a rounded rectangular frame one pixel wide using the current drawing colour.				
X1	Byte	Leftmost coordinate of the rectangle.		
Y1	Byte	Topmost coordinate of the rectangle.		
X2	Byte	Rightmost coordinate.		
Y2	Byte	Bottommost coordinate.		
Radius	Byte	Radius of curvature of the rectangle corners.		

3.8 Draw a Filled Rounded Rectangle	Dec	254 129	X1 Y1 X2 Y2 Radius	v8.3
	Hex	FE 81	X1 Y1 X2 Y2 Radius	
	ASCII	■ ü	X1 Y1 X2 Y2 Radius	
Draw a filled rounded rectangle using the current drawing colour.				
X1	Byte	Leftmost coordinate of the rectangle.		
Y1	Byte	Topmost coordinate of the rectangle.		
X2	Byte	Rightmost coordinate.		
Y2	Byte	Bottommost coordinate.		
Radius	Byte	Radius of curvature of the rectangle corners.		

3.9 Draw a Circle	Dec	254 123	X Y Radius	v8.3
	Hex	FE 7B	X Y Radius	
	ASCII	■ {	X Y Radius	
Draw a circular frame one pixel wide using the current drawing colour.				
X	Byte	Horizontal coordinate of the circle centre.		
Y	Byte	Vertical coordinate of the circle centre.		
Radius	Byte	Distance between the circle perimeter and centre.		

3.10 Draw a Filled Circle	Dec	254 124	X Y Radius	v8.3
	Hex	FE 7C	X Y Radius	
	ASCII	■ 	X Y Radius	
Draw a filled circle using the current drawing colour.				
X	Byte	Horizontal coordinate of the circle centre.		
Y	Byte	Vertical coordinate of the circle centre.		
Radius	Byte	Distance between the circle perimeter and centre.		

3.11 Draw an Ellipse	Dec	254 125	X Y XRradius YRadius	v8.3
	Hex	FE 7D	X Y XRradius YRadius	
	ASCII	■ }	X Y XRradius YRadius	
Draw an elliptical frame one pixel wide using the current drawing colour.				
X	Byte	Horizontal coordinate of the ellipse centre, zero indexed from left.		
Y	Byte	Vertical coordinate of the ellipse centre, zero indexed from top.		
XRradius	Byte	Distance between the furthest horizontal point on the ellipse perimeter and centre.		
YRadius	Byte	Distance between the furthest vertical point on the ellipse perimeter and centre.		



3.12 Draw a Filled Ellipse	Dec	254 127	X Y XRadius YRadius	v8.3
	Hex	FE 7F	X Y XRadius YRadius	
	ASCII	■ DEL	X Y XRadius YRadius	

Draw an ellipse using the current drawing colour.

X	Byte	Horizontal coordinate of the ellipse centre, zero indexed from left.
Y	Byte	Vertical coordinate of the ellipse centre, zero indexed from top.
XRadius	Byte	Distance between the furthest horizontal point on the ellipse perimeter and centre.
YRadius	Byte	Distance between the furthest vertical point on the ellipse perimeter and centre.

3.13 Scroll Screen	Dec	254 89	X1 Y1 X2 Y2 MoveX MoveY	v8.3
	Hex	FE 59	X1 Y1 X2 Y2 MoveX MoveY	
	ASCII	■ Y	X1 Y1 X2 Y2 MoveX MoveY	

Define and scroll the contents of a portion of the screen.

X1	Byte	Leftmost coordinate of the scroll window, zero indexed from left.
Y1	Byte	Topmost coordinate of the scroll window, zero indexed from top.
X2	Byte	Rightmost coordinate of the scroll window, zero indexed from left.
Y2	Byte	Bottommost coordinate of the scroll window, zero indexed from top.
MoveX	Signed Short	Number of pixels to scroll horizontally.
MoveY	Signed Short	Number of pixels to scroll vertically.

3.14 Initialize a Bar Graph	Dec	254 103	ID Type X1 Y1 X2 Y2	v8.3
	Hex	FE 67	ID Type X1 Y1 X2 Y2	
	ASCII	■ g	ID Type X1 Y1 X2 Y2	

Initialize a bar graph in memory for later implementation. Graphs can be located anywhere on the screen, but overlapping may cause distortion. Graph should be filled using the Draw a Bar Graph command.

ID	Byte	Unique bar identification number, between 0 and 255.
Type	Byte	Graph style, see Bar Graph Types.
X1	Byte	Leftmost coordinate.
Y1	Byte	Topmost coordinate.
X2	Byte	Rightmost coordinate.
Y2	Byte	Bottommost coordinate.

Table 16: Bar Graph Types

	Direction	Base
0	Vertical	Bottom
1	Horizontal	Left
2	Vertical	Top
3	Horizontal	Right



3.15 Initialize 9-Slice Bar Graph	Dec	254 115	ID	Type	X1	Y1	X2	Y2	Fore 9Slice	Back 9Slice	v8.3
	Hex	FE 73	ID	Type	X1	Y1	X2	Y2	Fore 9Slice	Back 9Slice	
	ASCII	■ s	ID	Type	X1	Y1	X2	Y2	Fore 9Slice	Back 9Slice	

Initialize a 9-slice bar graph in memory for later implementation. 9-slice graphs are also be filled using the Draw a Bar Graph command and are allocated to the same memory as regular bitmaps.

ID	Byte	Unique bar identification number, value between 0 and 255.
Type	Byte	Graph style, see Bar Graph Types.
X1	Byte	Leftmost coordinate of the 9-slice bar, zero indexed from left.
Y1	Byte	Topmost coordinate of the 9-slice bar, zero indexed from top.
X2	Byte	Rightmost coordinate of the 9-slice bar, zero indexed from left.
Y2	Byte	Bottommost coordinate of the 9-slice bar, zero indexed from top.
Fore 9Slice	Short	9-slice used for the foreground.
Back 9Slice	Short	9-slice used for the background.

3.16 Draw a Bar Graph	Dec	254 105	ID	Value	v8.3
	Hex	FE 69	ID	Value	
	ASCII	■ i	ID	Value	

Fill in a portion of a bar graph after initialization. Any old value will be overwritten by the new. Setting a value of zero before setting a new value will restore a graph should it become corrupted.

ID	Byte	Unique bar identification number, between 0 and 255.
Value	Byte	Portion of graph to fill in pixels, will not exceed display bounds.

3.17 Initialize a Strip Chart	Dec	254 110	ID	X1	Y1	X2	Y2	Min	Max	Step	Style	ID	v8.3
	Hex	FE 6E	ID	X1	Y1	X2	Y2	Min	Max	Step	Style	ID	
	ASCII	■ n	ID	X1	Y1	X2	Y2	Min	Max	Step	Style	ID	

Designate a portion of the screen for a chart. Visual changes will occur when the update command is issued.

ID	Byte	Unique chart identification number, value between 0 and 7.
X1	Byte	Leftmost coordinate of the strip chart, zero indexed from left.
Y1	Byte	Topmost coordinate of the strip chart, zero indexed from top.
X2	Byte	Rightmost coordinate of the strip chart, zero indexed from left.
Y2	Byte	Bottommost coordinate of the strip chart, zero indexed from top.
Min	Short	Minimum chart value.
Max	Short	Maximum chart value. For line styles, make max-min at least one pixel less than chart height.
Step	Byte	Scroll distance between updates, in pixels.
Style	Byte	Chart style value which is an OR'd combination of type and direction, as per the tables below.
ID	Short	9-slice file ID, if a 9-slice style strip chart is not desired send any value for this parameter.

Table 17: Strip Chart Directions (Bytes 7-4)

Direction	Description
0	Bottom origin, left shift
32	Left origin, upward shift
64	Top origin, right shift
96	Right origin, downward shift
128	Bottom origin, right shift
160	Left origin, downward shift
192	Top origin, left shift
224	Right origin, upward shift

Table 18: Strip Chart Types (Bytes 3-0)

Type	Description
0	Bar
1	Line
2	Step
3	Box
4	9-slice
5	Separated Bar
6	Separated Box



3.18 Update a Strip Chart	Dec	254 111	ID Value	v8.3
	Hex	FE 6F	ID Value	
	ASCII	■ o	ID Value	
Shift the specified strip chart and draw a new value.				
ID	Byte	Chart identification number, value between 0 and 7.		
Value	Short	Value to add to the chart.		

6.4 Fonts

4.1 Upload a Font File	Dec	254 36	ID Size Data	v8.0
	Hex	FE 24	ID Size Data	
	ASCII	■ \$	ID Size Data	
Upload a font to a graphic display. To create a font see the Font File Creation section, for upload protocol see the File Transfer Protocol or XModem Transfer Protocol entries. Default font is ID 1.				
ID*	Short	Unique font identification number, value between 0 and 1023.		
Size*	Integer	Size of the entire font file.		
Data	Byte(s)	Font file data, see the Font File Creation example.		

***Note:** ID and Size were changed from Byte and Short lengths respectively at firmware revision 8.1

4.2 Set the Current Font	Dec	254 49	ID	v8.0
	Hex	FE 31	ID	
	ASCII	■ 1	ID	
Set the font in use by specifying a unique identification number. Characters sent after the command will appear in the font specified; previous text will not be affected. Default is 1.				
ID*	Short	Unique font identification number, value between 0 and 1023.		

***Note:** ID was changed from a Byte length at firmware revision 8.5

4.3 Set Font Metrics	Dec	254 50	LineMargin TopMargin CharSpace LineSpace Scroll	v8.0
	Hex	FE 32	LineMargin TopMargin CharSpace LineSpace Scroll	
	ASCII	■ 2	LineMargin TopMargin CharSpace LineSpace Scroll	
Set the font spacing, or metrics, used with the current font. Changes only appear in text sent after command.				
LineMargin	Byte	Space between left of display and first column of text. Default 0.		
TopMargin	Byte	Space between top of display area and first row of text. Default 0.		
CharSpace	Byte	Space between characters. Default 0.		
Line Space	Byte	Space between character rows. Default 1.		
Scroll	Byte	Point at which text scrolls up screen to display additional rows. Default 1.		

4.4 Set Box Space Mode	Dec	254 172	Switch	v8.0
	Hex	FE AC	Switch	
	ASCII	■ ¼	Switch	
Toggle box space on or off. When on, a character sized box is cleared from the screen before a character is written. This eliminates any text or bitmap remnants behind the character. Default is on.				
Switch	Byte	1 for on or 0 for off.		



Font File Creation

Matrix Orbital graphic displays are capable of displaying text in a wide variety of styles customizable to suit any project design. Font files alter the style of text and appearance of the display.

By default, a Matrix Orbital graphic display is loaded with a small filled font in slot one and a future bk bt 16 style in slot two. Both are available at www.matrixorbital.ca/software/graphic_fonts.

The easiest way to create, add, or modify the fonts of any graphic display is through the MOGD# tool. This provides a simple graphic interface that hides the more complex intricacies of the font file.

Table 19: Example Font File Header

Maximum Width	Character Height	ASCII Start Value	ASCII End Value
5	7	104	106

The font file header contains four bytes: First, the number of columns in the widest character; usually 'w', second, the pixel height of each character, and finally, the start and end values of the character range. The range represents the values that must be sent to the display to trigger the characters to appear on the screen. In the example, the decimal values corresponding to the lowercase letters 'h' through 'j' will be used resulting in the range shown.

Table 20: Example Character Table

	MSB	LSB	Width
h	0	13	5
i	0	18	3
j	0	21	4

The character table contains information that allows the display to locate each individual character in a mass of character data. Each character has three bytes; two indicating its offset in the character data and one indicating its width. The offset takes into account the header and table bytes to point to the first byte of the character data it references. The first byte of the file, maximum width, has an offset of zero. The width byte of each character can be identical as in a fixed width font, or in our case, variable. The character table will become clearer after analyzing the final part of the font file, character data.

Table 21: Character 'h' Bitmap

1	0	0	0	0
1	0	0	0	0
1	0	1	1	0
1	1	0	0	1
1	0	0	0	1
1	0	0	0	1
1	0	0	0	1

Table 22: Character 'h' Data

1	0	0	0	0	1	0	0	84	132
0	0	1	0	1	1	0	1	2D	45
1	0	0	1	1	0	0	0	98	152
1	1	0	0	0	1	1	0	C6	198
0	0	1	0	0	0	0	0	20	32



The character data is a binary graphical representation of each glyph in a font. Each character is drawn on a grid containing as many rows as the height specified in the header and as many columns as the width specified in the character table. Cells are drawn by writing a one in their location and cleared by setting a value of zero. Starting at the top left, moving right, then down, eight of these cells form a character data byte. When all cells are accounted for, zeroes may be added to the last byte to complete it. A sample of an 'h' glyph is shown above. The data for the 'i' and 'j' characters will follow to complete the custom font file displayed below.

Table 23: Example Font File

Header	5 7 104 106
Character Table	0 13 5
	0 18 3
	0 21 4
Character Data	132 45 152 198 32
	67 36 184
	16 49 25 96

6.5 Bitmaps

5.1 Upload a Bitmap File	Dec	254 94	ID Size Data	v8.0
	Hex	FE 5E	ID Size Data	
	ASCII	■ ^	ID Size Data	
Upload a bitmap to a graphic display. To create a bitmap see the Bitmap File Creation section, for upload protocol see the File Transfer Protocol or XModem Transfer Protocol entries. Start screen is ID 1.				
ID*	Short	Unique bitmap identification number, value between 0 and 1023.		
Size*	Integer	Size of the entire bitmap file.		
Data	Byte(s)	Bitmap file data, see the Bitmap File Creation example.		

***Note:** ID and Size were changed from Byte and Short lengths respectively at firmware revision 8.1

5.2 Upload a Bitmap Mask	Dec	254 92 5	ID Size Data	v8.3
	Hex	FE 5C 05	ID Size Data	
	ASCII	■ \ ENQ	ID Size Data	
Upload a bitmap mask that can clear areas of the screen before a bitmap is drawn. Programmatically, (bitmap&mask) (screen&~mask) is shown when a bitmap is drawn. To create a mask see the Bitmap Masking section, for upload protocol see the File Transfer Protocol or XModem Transfer Protocol entries.				
ID	Short	Unique bitmap mask identification number, value between 0 and 1023.		
Size	Integer	Size of the entire mask file.		
Data	Byte(s)	Bitmap mask file data, see the Bitmap File Creation example.		



Bitmap File Creation

In addition to fonts, Matrix Orbital graphic displays can also hold a number of customizable bitmaps to provide further stylistic product integration. Like font files, bitmaps files are most easily uploaded to a display using MOGD#. However, the critical data component of the bitmap upload command is detailed below for reference.

The bitmap data block is similar to that of a font. However, as a bitmap is a single glyph, only a simple two byte header is required. First, one byte representing the bitmap width is sent, then one byte for the height. Each bitmap is merely encoded in binary fashion using a series of ones and zeroes. Again a grid can be created using the width and height specified in the upload command, populated in the manner above, and converted into byte values. A smiley face example is shown below to indicate the ultimate effect of the Matrix Orbital graphic stylization ability.

Table 24: Smiley Face Bitmap

0	1	0	1	0
0	0	0	0	0
1	0	0	0	1
0	1	1	1	0

Table 25: Smiley Face Data

0	1	0	1	0	0	0	0	50	80
0	0	1	0	0	0	1	0	22	34
1	1	1	0	0	0	0	0	E0	224

Table 26: Example Bitmap File

Header	5 4
Bitmap Data	80 34 224

Bitmap Masking

Like a regular bitmap, a mask can be loaded to the display and used to create a more polished result when drawing in populated areas. When defining a mask, all active values will clear any background information, while any inactive values will leave it untouched. This is best described with an example.

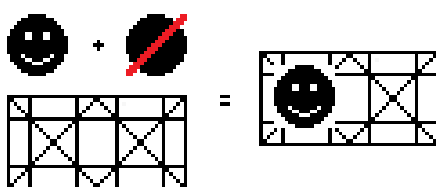

Figure 17: Drawing without a Mask

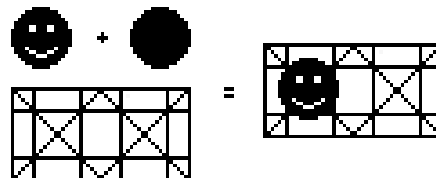

Figure 18: Drawing with a Mask

6.6 9-Slices

6.1 Upload a 9-Slice File	Dec	254 92 3	ID Size Data	v8.3
	Hex	FE 5C 03	ID Size Data	
	ASCII	■ \ ETX	ID Size Data	

Upload a 9-slice file to a graphic display. To create a 9-slice see the 9-Slice File Creation section, for upload protocol see the File Transfer Protocol or XModem Transfer Protocol entries.

ID	Short	Unique 9-slice identification number, value between 0 and 1023.
Size	Integer	Size of the 9-slice file.
Data	Byte(s)	9-slice file data, see the 9-Slice File Creation example.

6.2 Upload a 9-Slice Mask	Dec	254 92 6	ID Size Data	v8.3
	Hex	FE 5C 06	ID Size Data	
	ASCII	■ \ ACK	ID Size Data	

Upload a 9-slice mask that can clear areas of the screen before a 9-slice is drawn. Programmatically, (9slice&mask) | (screen&~mask) is shown when a bitmap is drawn. To create a mask see the 9-Slice File Creation section, for upload protocol see the File Transfer Protocol or XModem Transfer Protocol entries.

ID	Short	Unique 9-slice mask identification number, value between 0 and 1023.
Size	Integer	Size of the entire mask file.
Data	Byte(s)	9-slice mask file data, see the 9-Slice File Creation example.

6.3 Display a 9-Slice	Dec	254 91	ID X1 Y1 X2 Y2	v8.3
	Hex	FE 5B	ID X1 Y1 X2 Y2	
	ASCII	■ [ID X1 Y1 X2 Y2	

Displays a previously loaded 9-slice at the specified location.

ID	Short	Unique 9-slice identification number, value between 0 and 1023.
X1	Byte	Leftmost coordinate of the 9-slice.
Y1	Byte	Topmost coordinate of the 9-slice.
X2	Byte	Rightmost coordinate of the 9-slice.
Y2	Byte	Bottommost coordinate of the 9-slice.



9-Slice File Creation

A 9-slice file is a scalable graphic composed of nine different bitmap sections as shown below.

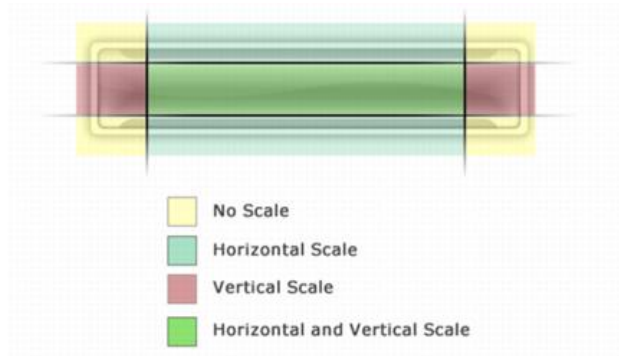

Figure 19: Adobe 9-slice Representation

The 9-slice file format requires that the bitmap dimensions and the locations of divisions be defined before a graphic is uploaded normally as shown in the Bitmap File Creation example.

Table 27: 9-slice file format

Width	One byte representing the width of the entire bitmap.
Height	One byte representing the height of the entire bitmap.
Top	One byte specifying the height of the top row section of the 9-slice.
Bottom	One byte specifying the height of the bottom row section of the 9-slice.
Left	One byte specifying the width of the left column section of the 9-slice.
Right	One byte specifying the width of the right column section of the 9-slice.
Bitmap Data	Data outlining the entire bitmap, as per the Bitmap File Creation example.

6.7 Animations

7.1 Upload an Animation File	Dec	254 92 4	File ID	Size	Data	v8.3
	Hex	FE 5C 04	File ID	Size	Data	
	ASCII	■ \ EOT	File ID	Size	Data	

Upload an animation file to a graphic display. To create an animation see the Animation File Creation section, for upload protocol see the File Transfer Protocol or XModem Transfer Protocol entries. Up to 16 animations can be displayed on the screen at one time, using the Display Animation command, but up to 1024 can be stored in memory for later use. Please note the total graphic memory size is 256KB.

File ID	Short	Unique animation file identification number, value between 0 and 1023.
Size	Integer	Size of the animation file.
Data	Byte(s)	Animation file data, see the Animation File Creation example.

7.2 Display Animation	Dec	254 193	ID	File ID*	X	Y	v8.3
	Hex	FE C1	ID	File ID*	X	Y	
	ASCII	■ ⊥	ID	File ID*	X	Y	

Load the first frame of the specified animation in its stopped state at the specified location. If an animation is already in use at that index it will be overwritten. Use the start animation command to play the displayed file.

ID	Byte	Unique animation identification number, value between 0 and 15.
File ID	Short	Unique animation file identification number, value between 0 and 1023.
X	Byte	Leftmost coordinate of animation.
Y	Byte	Topmost coordinate of animation.

***Note:** File ID word length variable was removed from this command at v8.4, and reintroduced in v8.5.

7.3 Delete Animation	Dec	254 199	ID	v8.3
	Hex	FE C7	ID	
	ASCII	■ 	ID	

Stop and delete the displayed animation specified.

ID	Byte	Animation number to delete, value between 0 and 15.
-----------	-------------	---

7.4 Start/Stop Animation	Dec	254 194	ID	Start	v8.3
	Hex	FE C2	ID	Start	
	ASCII	■ T	ID	Start	

Start or stop an animation that has been displayed.

ID	Byte	Animation number to start/stop, , value between 0 and 15.
Start	Byte	Any non-zero value will start the specified animation, 0 will stop it.

7.5 Set Animation Frame	Dec	254 197	ID	Frame	v8.3
	Hex	FE C5	ID	Frame	
	ASCII	■ +	ID	Frame	

Set the current frame of a displayed animation. If the frame exceeds the total number present, the animation will be set to the first frame.

ID	Byte	Animation number to control, value between 0 and 15.
Frame	Byte	Number of the frame to be displayed, value between 0 and 31.



7.6 Get Animation Frame	Dec	254 196	ID	v8.3
	Hex	FE C4	ID	
	ASCII	■ -	ID	
Get the current frame of a displayed animation.				
ID	Byte	Animation number to request frame number, value between 0 and 15.		
Response	Byte	Current frame number of the animation specified, value between 0 and 31.		

Animation File Creation

An animation file is a series of bitmaps, each displayed for a specified length of time within a continuous rotation. The file begins by specifying the number of frames, the offset of each block of bitmap information, and the time to display each frame. After which bitmap headers and data are transmitted for each frame, in the same manner as the Bitmap File Creation example.

Table 28: Animation file format

Total Frames	One byte representing the total number of frames in the animation
Offsets	One entry for each frame, 4 bytes indicating the start of the bitmap file. Maximum 32 frames
Times	Two bytes for each frame representing the length of time (100ms) for which it is displayed.
Header 1	Two bytes, one representing the width and one the height of the first bitmap.
Bitmap 1 Data	The first bitmap data, as per the Bitmap File Creation example.
...	...
Header 9	Two bytes, one representing the width and one the height of the last bitmap.
Bitmap 9 Data	The last bitmap data, as per the Bitmap File Creation example.

6.8 General Purpose Output

8.1 General Purpose Output On	Dec	254 87	Number	v8.0
	Hex	FE 57	Number	
	ASCII	■ W	Number	
Turns the specified GPO on, sourcing current from an output of five volts.				
Number	Byte	GPO to be turned on.		

8.2 General Purpose Output Off	Dec	254 86	Number	v8.0
	Hex	FE 56	Number	
	ASCII	■ V	Number	
Turns the specified GPO off, sinking current to an output of zero volts.				
Number	Byte	GPO to be turned off.		

8.3 Set Start Up GPO State	Dec	254 195	Number State	v8.0
	Hex	FE C3	Number State	
	ASCII	■ 	Number State	
Sets and saves the start up state of the specified GPO in non volatile memory. Changes will be seen on start up.				
Number	Byte	GPO to be controlled.		
State	Byte	1 for on or 0 for off.		



LED Indicators

The GLK19264A-7T-1U has 6 General Purpose Outputs which control 3 bi-colour LEDs. Red, green, and orange-yellow colours can be created using these software controlled GPOs. Odd numbered GPOs control red while even numbers switch the green aspects of the LEDs, as shown in the table below.

Table 29: LED Output

Colour	GPO _O	GPO _E
Yellow	0	0
Green	0	1
Red	1	0
Off	1	1

8.4 Set LED Indicators	Dec	254 90	Number Colour	v8.0
	Hex	FE 5A	Number Colour	
	ASCII	■ Z	Number Colour	
Immediately sets the state of the specified LED indicator to a specific colour. Temporary unless remember is on. LED indicators are numbered 0 to 2 from top to bottom.				
Number	Byte	LED indicator to be controlled.		
Colour	Byte	LED colour state as below.		

Table 30: LED Indicator Number

LED Indicator Position	Number
Top	0
Middle	1
Bottom	2

Table 31: LED Indicator Colour

State	Colour
Off	0
Green	1
Red	2
Yellow	3

6.9 Dallas One-Wire

9.1 Search for a One-Wire Device	Dec	254 200 2	v8.0
	Hex	FE C8 02	
	ASCII	■ ℒ SOT	
Sends a search query to each of the up to 32 devices on the one wire bus. Any connected device will respond with an identification packet.			
Response	Bytes [14]	Dallas One-Wire identification packet as shown below.	

Table 32: Dallas One-Wire Packet Information

Offset	Length	Value	Description
0	2	9002	Preamble
2	1	138	Another device packet will follow OR
		10	Last device packet
3	1	49	Packet Type
4	1	0	Error Code (0 indicates success)
5	8		Device Address
13	1	0	CRC8 address check (0 indicates validity)



9.2 Dallas One-Wire Transaction	Dec	254 200 1	Flags Send Bits Receive Bits Data	v8.0
	Hex	FE C8 01	Flags Send Bits Receive Bits Data	
	ASCII	■ ⌞ STX	Flags Send Bits Receive Bits Data	
Performs a single Dallas 1-Wire transaction. Consult your device documentation for information regarding device specific protocols. If an error is encountered, a corresponding value will be returned by the device.				
Flags	Byte	Flags for transaction, see below.		
Send Bits	Byte	Number of bytes to be sent to the device.		
Receive Bits	Byte	Number of bytes expected to be received from the device.		
Data	Byte(s)	Data to be transmitted LSB to MSB.		

Table 33: Dallas One-Wire Flags

Bit	Flag Description
7	
6	Unused
5	
4	0 (Future Compatibility)
3	Add CRC8 to transaction
2	0 (Future Compatibility)
1	Read CRC8 from transaction
0	Reset Bus prior to transaction

Table 34: Dallas One-Wire Errors

Code	Error Description
0	Success
1	Unknown Command
2	No Devices Found
3	Fatal Search Error

6.10 Piezo Buzzer

10.1 Activate Piezo Buzzer	Dec	254 187	Frequency Time	v8.0
	Hex	FE BB	Frequency Time	
	ASCII	■ 7	Frequency Time	

Activates a buzz of specific frequency from the onboard piezo buzzer for a specified length of time.

Frequency	Short	Frequency of buzz in hertz.
Time	Short	*Duration of the beep in milliseconds.

***Note:** When a beep precedes a delay command, the duration of the beep must be shorter than that of the delay.

10.2 Set Default Buzzer Beep	Dec	254 188	Frequency Duration	v8.3
	Hex	FE BC	Frequency Duration	
	ASCII	■ 7	Frequency Duration	

Set the frequency and duration of the default beep transmitted when the bell character is transmitted.

Frequency	Short	Frequency of the beep in Hertz, default 440Hz.
Duration	Short	Duration of the beep in milliseconds, default 100ms.

10.3 Set Keypad Buzzer Beep	Dec	254 182	Frequency Duration	v8.4
	Hex	FE B6	Frequency Duration	
	ASCII	■ 7	Frequency Duration	

Set the frequency and duration of the default beep transmitted when a key is pressed.

Frequency	Short	Frequency of the beep in Hertz, default is 0 or off.
Duration	Short	Duration of the beep in milliseconds, default is 0 or off.



6.11 Keypad

11.1 Auto Transmit Key Presses On	Dec	254 65	v8.0
	Hex	FE 41	
	ASCII	■ A	

Key presses are automatically sent to the host when received by the display. Use this mode for I2C transactions.

11.2 Auto Transmit Key Presses Off	Dec	254 79	v8.0
	Hex	FE 4F	
	ASCII	■ O	

Key presses are held in the 10 key buffer to be polled by the host using the Poll Key Press command. Default is Auto Transmit on.

11.3 Poll Key Press	Dec	254 38	v8.0
	Hex	FE 26	
	ASCII	■ &	

Reads the last unread key press from the 10 key display buffer. If another key is stored in the buffer the MSb will be 1, the MSb will be 0 when the last key press is read. If there are no stored key presses a value of 0 will be returned. Auto transmit key presses must be turned off for this command to be successful, do not use with I²C.

Response | **Byte** | Value of key pressed (MSb determines additional keys to be read).

11.4 Clear Key Buffer	Dec	254 69	v8.0
	Hex	FE 45	
	ASCII	■ E	

Clears all key presses from the key buffer.

11.5 Set Debounce Time	Dec	254 85	Time	v8.0
	Hex	FE 55	Time	
	ASCII	■ U	Time	

Sets the time between a key press and a key read by the display. Most switches will bounce when pressed; the debounce time allows the switch to settle for an accurate read. Default is 8 representing approximately 52ms.

Time | **Byte** | Debounce increment (debounce time = Time * 6.554ms).

11.6 Set Auto Repeat Mode	Dec	254 126	Mode	v8.0
	Hex	FE 7E	Mode	
	ASCII	■ DEL	Mode	

Sets key press repeat mode to typematic or hold. In typematic mode if a key press is held, by default the key value is transmitted immediately, then 5 times a second after a 1 second delay. In hold mode, the key down value is transmitted once when pressed, and then the key up value is sent when the key is released. Default is typematic.

Mode | **Byte** | 1 for hold mode or 0 for typematic.



11.7 Auto Repeat Mode Off	Dec	254 96	v8.0
	Hex	FE 60	
	ASCII	■ `	

Turns auto repeat mode off. Default is on (typematic).

11.8 Assign Keypad Codes	Dec	254 213	Key Down	Key Up	v8.0
	Hex	FE D5	Key Down	Key Up	
	ASCII	■ F	Key Down	Key Up	

Assigns the key down and key up values sent to the host when a key press is detected. A key up and key down value must be sent for every key, a value of 255 will leave the key unaltered. Defaults are shown below.

Key Down	Bytes [9]	Key down values.
Key Up	Bytes [9]	Key up values.

		Key Down		
		Columns		
		1	2	3
R o w s	1			
	2			N/A*
	3			N/A*

Figure 20: Default Tactile Key Down Values

		Key Up		
		Columns		
		1	2	3
R o w s	1			
	2			N/A*
	3			N/A*

Figure 21: Default Tactile Key Up Values

***Note:** Values are not mapped to a physical key.

11.9 Keypad Backlight Off	Dec	254 155	v8.4
	Hex	FE 9B	
	ASCII	■ ¸	

Turns the keypad backlight off.

11.10 Set Keypad Brightness	Dec	254 156	Brightness	v8.4
	Hex	FE 9C	Brightness	
	ASCII	■ £	Brightness	

Immediately sets the keypad brightness. On time is set using the Backlight On command. Default is 255.

Brightness	Byte	Brightness level from 0(Dim) to 255(Bright).
------------	------	--



11.11 Set Auto Backlight	Dec	254 157	Setting	v8.4
	Hex	FE 9D	Setting	
	ASCII	■ ¥	Setting	

Set the way the display and keypad backlights respond when a key is pressed. The options in the tables below allow a keypress to turn on the display and/or keypad backlights after they have timed out or been turned off.

Setting **Byte** What portions of the unit light on a keypress, if any, and if that press is returned.

Table 35: AutoBacklight Settings

Transmit First Keypress		Omit First Keypress	
0	No Lighting Change	8	No Lighting Change
1	Light Keypad Backlight	9	Light Keypad Backlight
2	Light Display Backlight	10	Light Display Backlight
3	Light Keypad and Display	11	Light Keypad and Display

11.12 Set Typematic Delay	Dec	254 159	Delay	v8.4
	Hex	FE 9F	Delay	
	ASCII	■ f	Delay	

Sets the delay between the first key press and first typematic report when a key is held in typematic mode.

Delay **Byte** Time key must be held to trigger typematic reports, specified in 100ms, default is 10 (1s).

11.13 Set Typematic Interval	Dec	254 158	Interval	v8.4
	Hex	FE 9E	Interval	
	ASCII	■ Pts	Interval	

Sets the interval between reported key presses when a key is held and the display is in typematic mode.

Interval **Byte** Time between key reports, specified in 100ms increments, default is 2 (200ms).

6.12 Display Functions

12.1 Backlight On	Dec	254 66	Minutes	v8.0
	Hex	FE 42	Minutes	
	ASCII	■ B	Minutes	

Turns the display backlight on for a specified length of time. If an inverse display color is used this command will essentially turn on the text.

Minutes **Byte** Number of minutes to leave backlight on, a value of 0 leaves the display on indefinitely.

12.2 Backlight Off	Dec	254 70		v8.0
	Hex	FE 46		
	ASCII	■ F		

Turns the display backlight off. If an inverse display colour is used this command will turn off the text.



12.3 Set Brightness	Dec	254 153	Brightness	v8.0
	Hex	FE 99	Brightness	
	ASCII	■ Ö	Brightness	

Immediately sets the backlight brightness. If an inverse display color is used this represents the text colour intensity instead. Default is 255.

Brightness **Byte** Brightness level from 0(Dim) to 255(Bright).

12.4 Set and Save Brightness	Dec	254 152	Brightness	v8.0
	Hex	FE 98	Brightness	
	ASCII	■ ÿ	Brightness	

Immediately sets and saves the backlight brightness. Although brightness can be changed using the set command, it is reset to this saved value on start up. Default is 255.

Brightness **Byte** Brightness level from 0(Dim) to 255(Bright).

12.5 Set Backlight Colour	Dec	254 130	Red Green Blue	v8.0
	Hex	FE 82	Red Green Blue	
	ASCII	■ é	Red Green Blue	

Set the colour of a tri-colour backlight. Only for tri-colour displays. Default is white (255, 255, 255).

Red **Byte** Brightness level of Red from 0(Dim) to 255(Bright).

Green **Byte** Brightness level of Green from 0(Dim) to 255(Bright).

Blue **Byte** Brightness level of Blue from 0(Dim) to 255(Bright).

12.6 Set Contrast	Dec	254 80	Contrast	v8.0
	Hex	FE 50	Contrast	
	ASCII	■ P	Contrast	

Immediately sets the contrast between background and text. If an inverse display color is used this also represents the text brightness. Default is 128.

Contrast **Byte** Contrast level from 0(Light) to 255(Dark).

12.7 Set and Save Contrast	Dec	254 145	Contrast	v8.0
	Hex	FE 91	Contrast	
	ASCII	■ æ	Contrast	

Immediately sets and saves the contrast between background and text. Although contrast can be changed using the set command, it is reset to this saved value on start up. Default is 128.

Contrast **Byte** Contrast level from 0(Light) to 255(Dark).



6.13 Scripting

13.1 Upload a Script File	Dec	254 92 2	ID	Length	Data	v8.3
	Hex	FE 5C 02	ID	Length	Data	
	ASCII	■ \ STX	ID	Length	Data	

Save a list of commands to be executed at a later time. Bytes are saved as if they are being sent by the host, for upload protocol see the File Transfer Protocol or XModem Transfer Protocol entries.

ID	Short	Unique identification number of the script, value between 0 and 1023.
Length	Integer	Length of the script in bytes.
Data	Byte(s)	Data to be sent to the display when the script executes.

13.2 Set Scripted Key	Dec	254 141	ID	Row	Column	Down Script	Up Script	v8.4
	Hex	FE 8D	ID	Row	Column	Down Script	Up Script	
	ASCII	■ ì	ID	Row	Column	Down Script	Up Script	

Create a key behaviour that responds to a press event by executing an uploaded script.

ID	Byte	Unique key identification number, maximum based on number of keys available.
Row	Byte	The row value of the key to be linked to the specified scripts.
Column	Byte	The column value of the key to be linked to the specified scripts.
Down Script	Short	Identification number of the script to run on a down event, value between 0 and 1023.
Up Script	Short	Identification number of the script to run on an up event, value between 0 and 1023.

13.3 Run Script File	Dec	254 93	ID	v8.3
	Hex	FE 5D	ID	
	ASCII	■]	ID	

Execute a previously loaded script. Script 0 is loaded automatically on startup, unless in override mode.

ID	Short	Identification number of the script to run, value between 0 and 1023.
-----------	--------------	---

6.14 Filesystem

14.1 Delete Filesystem	Dec	254 33 89 33	v8.0
	Hex	FE 21 59 21	
	ASCII	■ ! Y !	

Completely erase all fonts and bitmaps from a graphic display. Extended length of the command is intended to prevent accidental execution. To ensure filesystem integrity, cycle power to the display after erasure.

14.2 Delete a File	Dec	254 173	Type ID	v8.0
	Hex	FE AD	Type ID	
	ASCII	■ i	Type ID	

Removes a single font or bitmap file given the type and unique identification number. Cycle power after deletion.

Type	Byte	0 for font or 1 for bitmap.
ID*	Short	Unique identification number of font or bitmap to be deleted, value between 0 and 1023.

***Note:** ID was changed from a Byte length at firmware revision 8.1



14.3 Get Filesystem Space	Dec	254 175	v8.0
	Hex	FE AF	
	ASCII	■ »	
Returns the amount of space remaining in the display for font or bitmap uploads.			
Response	Integer	Number of bytes remaining in memory.	

14.4 Get Filesystem Directory	Dec	254 179	v8.0
	Hex	FE B3	
	ASCII	■	
Returns a directory to the contents of the filesystem. The total number and type of each entry will be provided.			
Response	Short	Number of entries.	
	Byte(s) [8]	8 identification bytes for each entry.	

Table 36: Filesystem Identification Bytes

Byte	7	6	5	4	3	2	1	0
Description	Size(MSB)	Size	Size	Size(LSB)	Type(4)/ID(4)	ID (LSB)	Start Page (MSB)	Start Page (LSB)

Table 37: Extended Byte Descriptions

Size	The complete file size.
Type/ID	First four bits designate file type, 0 for font or 1 for bitmap, remaining 12 bits indicate ID number.
Start Page	Memory start page, a value of 0 indicates entry is not in use.

***Note:** ID and Size were changed from Byte and Short lengths respectively at firmware revision 8.1

14.5 Filesystem Upload	Dec	254 176	Size Data	v8.0
	Hex	FE B0	Size Data	
	ASCII	■	Size Data	
This command will upload a filesystem image to the display. The size used is almost always the entire memory. Filesystem data can be uploaded LSB to MSB using the File Transfer Protocol.				
Size	Integer	Size of the filesystem to upload.		
Data	Byte(s)	Filesystem data to upload.		

14.6 Filesystem Download	Dec	254 48	v8.0
	Hex	FE 30	
	ASCII	■ 0	
Downloads complete filesystem containing all fonts and bitmaps stored in the display using the File Transfer Protocol. A veritable heap of data.			
Response	Integer	Size of the filesystem to download.	
	Byte(s)	Filesystem data to download.	



14.7 File Download	Dec	254 178	Type ID	v8.0
	Hex	FE B2	Type ID	
	ASCII	■	Type ID	
Downloads a single font or bitmap file from the display to the host using the File Transfer Protocol.				
Type	Byte	Variable length, see File Types .		
ID	Short	Unique identification number of font or bitmap to download, value between 0 and 1023.		
Response	Integer	File size.		
	Byte(s)	File data.		

***Note:** ID was changed from a Byte length at firmware revision 8.1

14.8 File Move	Dec	254 180	Old Type	Old ID	New Type	New ID	v8.0
	Hex	FE B4	Old Type	Old ID	New Type	New ID	
	ASCII	■	Old Type	Old ID	New Type	New ID	
Used to move a single file and/or alter the type of an existing file. Old ID location must be valid and new ID empty.							
Old Type	Byte	Original file type, value between 0 and 1023, see File Types .					
Old ID	Short	Original unique file identification number, value between 0 and 1023.					
New Type	Byte	New file type, see File Types .					
New ID	Short	New unique file identification number.					

Table 38: File Types

Font	Bitmap	Script	9-Slice	Animation
0	1	2	3	4

***Note:** ID was changed from a Byte length at firmware revision 8.1

14.9 XModem Filesystem Upload	Dec	254 219 133 6 48	Size	Data	v8.1
	Hex	FE DB 85 6 30	Size	Data	
	ASCII	■	à ACK 0	Size Data	
Upload a filesystem image to the display using the XModem protocol. The size used is almost always the entire memory. Filesystem data is uploaded LSB to MSB using the XModem Transfer Protocol.					
Size	Integer	Size of the filesystem to upload.			
Data	Byte(s)	Filesystem data to upload, must be padded to an even multiple of 256 bytes.			

14.10 XModem Filesystem Download	Dec	254 222 133 6 48	v8.3
	Hex	FE DE 85 6 30	
	ASCII	■	
Downloads the complete filesystem using the XModem Transfer Protocol. A veritable heap of data, transmitted at a decent pace.			
Response	Integer	Size of the filesystem to download.	
	Byte(s)	Filesystem data to download, an even multiple of 256 bytes.	



14.11 XModem File Upload	Dec	254 220 133 6 48	File ID	Type	Size	Data	v8.3
	Hex	FE DC 85 6 30	File ID	Type	Size	Data	
	ASCII	■ ■ à ACK 0	File ID	Type	Size	Data	
Uploads a single file to the display using the XModem Transfer Protocol. Unlike the standard protocol, there is one XModem upload command for all file types, see File Types for a complete list.							
File ID	Short	Unique identification number for the file to upload, value between 0 and 1023.					
Type	Byte	Type of file to upload, see File Types .					
Size	Integer	Size of the file to upload.					
Data	Byte(s)	File data to upload, must be padded to an even multiple of 128 bytes.					

14.12 XModem File Download	Dec	254 221 133 6 48	File ID	Type				v8.3
	Hex	FE DD 85 6 30	File ID	Type				
	ASCII	■ à ACK 0	File ID	Type				
Downloads a single file from the display to the host using the XModem Transfer Protocol.								
File ID	Short	Unique identification number for the file to download, value between 0 and 1023.						
Type	Byte	Type of file to download, see File Types .						
Response	Integer	Size of the filesystem to download.						
	Byte(s)	Filesystem data to download, an even multiple of 128 bytes, may be padded with 255s.						

File Transfer Protocol

Once a bitmap or font file has been created and paired to its command it must be sent using a file protocol developed specifically for Matrix Orbital displays. Once a file upload command has been sent requesting a unique reference number and specifying the file size required, the display will respond indicating whether it has enough room to save the file or not. As is the case throughout the upload protocol, a response of 1 will indicate confirmation while an 8 corresponds to rejection and will terminate the session.

Table 39: Upload Protocol Responses

Value	Action	Description
1	Acknowledged	Transfer successful, upload continues
8	Not Acknowledged	Transfer failed, abort upload

Once a file is confirmed to fit within the display, the upload will begin. A protocol is used here to ensure each byte is uploaded successfully. After each byte is sent, the module will echo it back to the host. It should then be checked against the value originally sent before a confirmation byte of 1 is returned. If the transmitted and echoed values do not match the upload should be aborted by sending a value of 8 instead. The upload will continue in this manner as indicated by the examples below which utilize familiar font and bitmap files.



Table 40: Font Upload Protocol

Host	Display	Comments
254		Command Prefix
36		Upload Font File Command
1		Reference ID LSB
0		Reference ID MSB
31		Font File Size LSB
0		Font File Size
0		Font File Size
0		Font File MSB
	1	Acknowledge Size
5		First Font Data Byte
	5	Echo Data Byte
1		Acknowledge Data Byte
7		Second Font Data Byte
...
96		Last Font Data Byte
	96	Echo Data Byte
1		Acknowledge Data Byte

Table 41: Bitmap Upload Protocol

Host	Display	Comments
254		Command Prefix
94		Upload Bitmap File Command
1		Reference ID LSB
0		Reference ID MSB
5		Bitmap File Size LSB
0		Bitmap File Size
0		Bitmap File Size
0		Bitmap File MSB
	1	Acknowledge Size
5		First Bitmap Data Byte
	5	Echo Data Byte
1		Acknowledge Data Byte
4		Second Bitmap Data Byte
...
224		Last Bitmap Data Byte
	224	Echo Data Byte
1		Acknowledge Data Byte

It should be noted that the display has a timeout setting of 2.1 seconds before it resets to prevent it from hanging during the upload process. Upon reset, the values 254 and 212 will be returned to indicate an error or lengthy delay has occurred in the upload process. If everything goes smoothly, the protocol will end with the host transmitting a final confirmation byte and the font will be stored in the display ready for any application.

XModem Transfer Protocol

In addition to its original simple upload format, Matrix Orbital has added an XModem based protocol. This facilitates much faster download speeds by increasing the packet size from 1 byte to 128 bytes and using only a two byte CRC for error checking, greatly increasing throughput. To begin the upload, a series of command bytes are sent, a list of valid file type bytes is show in the File Types table. Once the command bytes are sent, the true size of the file is sent in four bytes, least significant byte first. At this point the display will respond with a C if the file fits or a NAK otherwise. Please note that these values are different than those of the original protocol as seen in the XModem Message Bytes table. If a NAK is seen at any point by the host, the upload is to be aborted in the same fashion as the regular protocol. If the file will fit, the start of header byte will be sent by the host, followed by a block count, in regular and inverted format, representing the number of 128 byte blocks remaining to be sent. The display will then check to make sure the block count value matches its own, if it doesn't it will NAK. The host can then send a 128 byte block of data followed by that blocks high and low CRC16 bytes. The display then performs a CRC check on the data receive and ACKs if it matches that which was sent. Transfer continues with a block count and continues in this way until the end of file is reached. Files may be padded with 255 values to reach an even multiple of 128 bytes in size, but the download command will always report true size. Once the end of the upload file is reached, the host should transmit a single end of transmission byte. If the end of file is expected, the display will ACK one last time.



Table 42: XModem File Upload Protocol

Host	Display	Comments
254		Command Prefix
220		XModem Upload Command
133		Command Byte One
6		Command Byte Two
48		Command Byte Three
1		File ID LSB
0		File ID MSB
1		File Type
0		Size LSB
0		Size
1		Size
0		Size MSB
	67	C (If file fits)
1		Start of Header
128		Block Count
127		Inverted Block Count (255-Count)
<128 B>		128 Byte Data Block
30		*CRC MSB
71		*CRC LSB
	6	ACK (NAK if counts don't match)
...
4		End of Transmission
	6	ACK (NAK if EOT is not expected)

Table 43: XModem File Download Protocol

Host	Display	Comments
254		Command Prefix
221		XModem Download Command
133		Command Byte One
6		Command Byte Two
48		Command Byte Three
1		File ID LSB
0		File ID MSB
1		File Type
	0	Size LSB (NAK if not found)
	0	Size
	1	Size
	0	Size MSB
67		C
	1	Start of Header
	128	Block Count
	127	Inverted Block Count (255-Count)
	<128 B>	128 Byte Data Block
	30	*CRC MSB
	71	*CRC LSB
	6	ACK (NAK if counts don't match)
...
	4	End of Transmission
	6	ACK (NAK if EOT is not expected)

Table 44: XModem Message Bytes

Value	Action	Description
1	Start of Header	Begin upload transfer
4	End of Transmission	End completed upload transfer
6	Acknowledged	Transfer successful, upload continues
21	Not Acknowledged	Transfer failed, upload aborted
67	C	Confirmation that file will fit

***Note:** CRC bytes are calculated using the XMODEM CRC-CCITT algorithm available at: <http://www.matrixorbital.ca/appnotes/XModem/y modem.txt>.



6.15 Data Security

15.1 Set Remember	Dec	254 147	Switch	v8.0
	Hex	FE 93	Switch	
	ASCII	■ ô	Switch	
Allows changes to specific settings to be saved to the display memory. Writing to non-volatile memory can be slow and each change consumes 1 write of at least 100,000 available. The Command Summary outlines which commands are saved always, never, and when this command is on only. Remember is off by default.				
Switch	Byte	1 for on or 0 for off.		

15.2 Set Data Lock	Dec	254 202 245 160	Level	v8.0
	Hex	FE CA F5 A0	Level	
	ASCII	■ J̄ J á	Level	
Temporarily locks certain aspects of the display to ensure no inadvertent changes are made. The lock is released after a power cycle. A new level overrides the old, and levels can be combined. Default is 0.				
Level	Byte	Lock level, see Data Lock Bits table.		

Table 45: Data Lock Bits

Display	Command	Filesystem	Setting	Address	Reserved	Reserved	Reserved
7	6	5	4	3	2	1	0

Table 46: Lock Parameters

Reserved	Place holders only, should be 0
Address	Locks the Baud Rate and I2C address
Setting	Locks all settings from being saved
Filesystem	Locks all bitmaps and fonts
Command	Locks all commands, text can still be written
Display	Locks entire display, no new text can be displayed

15.3 Set and Save Data Lock	Dec	254 203 245 160	Level	v8.0
	Hex	FE CB F5 A0	Level	
	ASCII	■ T̄ J á	Level	
Locks certain aspects of the display to ensure no inadvertent changes are made. The lock is not affected by a power cycle. A new level overrides the old, and levels can be combined. Default is 0.				
Level	Byte	See Data Lock Bits table.		

6.16 Miscellaneous

16.1 Write Customer Data	Dec	254 52	Data	v8.0
	Hex	FE 34	Data	
	ASCII	■ 4	Data	
Saves a user defined block of data to non-volatile memory. Useful for storing display information for later use.				
Data	Byte(s)	User defined data.		



7 Appendix

7.1 Command Summary

Available commands below include identifying number, required parameters, the returned response and an indication of whether settings are remembered always, never, or with remember set to on.

Table 48: Communication Command Summary

Name	Dec	Hex	ASCII	Parameters	Response	Remembered
Change Baud Rate	57	39	9	Byte	None	Always
Change I2C Slave Address	51	33	3	Byte	None	Always
Transmission Protocol Select	160	A0	á	Byte	None	Remember On
Set a Non-Standard Baud Rate	164	A4	ñ	Integer	None	Always
Set Flow Control Mode	63	3F	?	Byte	None	Remember On
Set Hardware Flow Control Trigger Level	62	3E	>	Byte	None	Remember On
Turn Software Flow Control On	58	3A	:	Byte[2]	None	Remember On
Turn Software Flow Control Off	59	3B	;	None	None	Remember On
Set Software Flow Control Response	60	3C	<	Byte[2]	None	Remember On
Echo	255	FF		Short, Byte[]	Byte[]	Never
Delay	251	FB	√	Short	None	Never
Software Reset	253	FD	²	Byte[4]	Byte[2]	Never

Table 49: Text Command Summary

Name	Dec	Hex	ASCII	Parameters	Response	Remembered
Clear Screen	88	58	X	None	None	Never
Go Home	72	48	H	None	None	Never
Set Cursor Position	71	47	G	Byte[2]	None	Never
Set Cursor Coordinate	121	79	y	Byte[2]	None	Never
Initialize Text Window	43	2B	+	Byte[5], Short, Byte[3]	None	Remember On
Set Text Window	42	2A	*	Byte	None	Never
Clear Text Window	44	2C	,	Byte	None	Never
Initialize Label	45	2D	-	Byte[7], Short, Byte{2}	None	Remember On
Initialize Scrolling Label	47	2F	/	Byte[7], Short, Byte[2], Short, Byte	None	Remember On
Update Label	46	2E	.	Byte, String	None	Never
Auto Scroll On	81	51	Q	None	None	Remember On
Auto Scroll Off	82	52	R	None	None	Remember On



Table 50: Drawing Command Summary

Name	Dec	Hex	ASCII	Parameters	Response	Remembered
Set Drawing Colour	99	63	c	Byte	None	Remember On
Draw Pixel	112	70	p	Byte[2]	None	Never
Draw a Line	108	6C	l	Byte[4]	None	Never
Continue a Line	101	65	e	Byte[2]	None	Never
Draw a Rectangle	114	72	r	Byte[5]	None	Never
Draw a Filled Rectangle	120	78	x	Byte[5]	None	Never
Draw a Rounded Rectangle	128	80	Ç	Byte[5]	None	Never
Draw a Filled Rounded Rectangle	129	81	ü	Byte[5]	None	Never
Draw a Circle	123	7B	{	Byte[3]	None	Never
Draw a Filled Circle	124	7C		Byte[3]	None	Never
Draw an Ellipse	125	7D	}	Byte[4]	None	Never
Draw a Filled Ellipse	127	7F	DEL	Byte[4]	None	Never
Scroll Screen	89	59	Y	Byte[4], Short[2]	None	Never
Initialize a Bar Graph	103	67	g	Byte[6]	None	Remember On
Initialize 9-Slice Bar Graph	115	73	s	Byte[6], Short[2]	None	Remember On
Draw a Bar Graph	105	69	i	Byte[2]	None	Never
Initialize a Strip Chart	106	6A	n	Byte[5], Short[2], Byte[2], Short	None	Remember On
Update a Strip Chart	107	6B	o	Byte, Short	None	Never

Table 51: Font Command Summary

Name	Dec	Hex	ASCII	Parameters	Response	Remembered
Upload a Font File	36	24	\$	Short, Integer, Byte[]	See Font File Creation	Always
Set the Current Font	49	31	1	Short	None	Never
Set Font Metrics	50	32	2	Byte[5]	None	Remember On
Set Box Space Mode	172	AC	¼	Byte	None	Remember On

Table 52: Bitmap Command Summary

Name	Dec	Hex	ASCII	Parameters	Response	Remembered
Upload a Bitmap File	94	5E	^	Short, Integer, Byte[]	See Bitmap File Creation	Always
Upload a Bitmap Mask	92	5C	\ ENQ	Short, Integer, Byte[]	See Bitmap File Creation	Always
Draw a Bitmap from Memory	98	62	b	Short, Byte[2]	None	Never
Draw a Partial Bitmap	192	C0	L	Short, Byte[6]	None	Never
Draw a Bitmap Directly	100	64	d	Byte[2], Byte[]	None	Never



Table 53: 9-Slice Command Summary

Name	Dec	Hex	ASCII	Parameters	Response	Remembered
Upload a 9-Slice File	92 3	5C 03	\ ETX	Short, Integer, Byte[]	See 9-Slice File Creation	Always
Upload a 9-Slice Mask	92 6	5C 06	\ ACK	Short, Integer, Byte[]	See 9-Slice File Creation	Always
Display a 9-Slice	91	5B	[Short, Byte[4]	None	Never

Table 54: Animation Command Summary

Name	Dec	Hex	ASCII	Parameters	Response	Remembered
Upload an Animation File	92 4	5C 04	\ EOT	Short, Integer, Byte[]	See Animation File Creation	Always
Display Animation	193	C1	⊥	Byte[4], Byte[]	None	Never
Delete Animation	199	C7		Byte	None	Always
Start/Stop Animation	194	C2	⊥	Byte[2]	None	Never
Set Animation Frame	197	C5	⊥	Byte[2]	None	Never
Get Animation Frame	196	C4	-	Byte	Byte	Never

Table 55: General Purpose Output Command Summary

Name	Dec	Hex	ASCII	Parameters	Response	Remembered
General Purpose Output On	86	56	V	Byte	None	Never
General Purpose Output Off	87	57	W	Byte	None	Never
Set Start Up GPO State	195	C3	⊥	Byte[2]	None	Always
Set LED Indicators	90	5A	Z	Byte [2]	None	Remember On

Table 56: Dallas One-Wire Command Summary

Name	Dec	Hex	ASCII	Parameters	Response	Remembered
Search for a One-Wire Device	200, 2	C8, 02	⌞, sOT	None	Byte[14]	Never
Dallas One-Wire Transaction	200, 1	C8, 01	⌞, sTX	Byte[3], Byte[]	Byte[]	Never

Table 57: Piezo Buzzer Command Summary

Name	Dec	Hex	ASCII	Parameters	Response	Remembered
Activate Piezo Buzzer	187	BB	⌞	Short[2]	None	Never
Set Default Buzzer Beep	188	BC	⌞	Short[2]	None	Remember On
Set Keypad Buzzer Beep	182	B6	⌞	Short[2]	None	Remember On



Table 58: Keypad Command Summary

Name	Dec	Hex	ASCII	Parameters	Response	Remembered
Auto Transmit Key Presses On	65	41	A	None	None	Remember On
Auto Transmit Key Presses Off	79	4F	`	None	None	Remember On
Poll Key Press	38	26	&	None	Byte	Never
Clear Key Buffer	69	45	E	None	None	Never
Set Debounce Time	85	55	U	Byte	None	Remember On
Auto Repeat Mode Off	96	60	`	None	None	Remember On
Assign Keypad Codes	213	D5	ƒ	Byte[25], Byte[25]	None	Always
Keypad Backlight Off	155	98	¢	None	None	Never
Set Keypad Brightness	156	9C	£	Byte	None	Remember On
Set Auto Backlight	157	9D	¥	Byte	None	Always
Set Typematic Delay	159	9F	f	Byte	None	Remember On
Set Typematic Interval	158	9E	ƒs	Byte	None	Remember On

Table 59: Display Functions Command Summary

Name	Dec	Hex	ASCII	Parameters	Response	Remembered
Backlight On	66	42	B	Byte	None	Remember On
Backlight Off	70	46	F	None	None	Remember On
Set Brightness	153	99	Ö	Byte	None	Remember On
Set and Save Brightness	152	98	ÿ	Byte	None	Always
Set Contrast	80	50	P	Byte	None	Remember On
Set and Save Contrast	145	91	æ	Byte	None	Always

Table 60: Scripting Functions Command Summary

Name	Dec	Hex	ASCII	Parameters	Response	Remembered
Upload a Script File	92 2	5C 02	\stx	Short, Integer, Byte[]	None	Always
Set Scripted Key	141	8D	ì	Byte[3], Short[2]	None	Remember On
Run Script File	93	5D]	Short	None	Never



Table 61: Filesystem Command Summary

Name	Dec	Hex	ASCII	Parameters	Response	Remembered
Delete Filesystem	33, 89, 33	21, 59, 21	!, Y, !	None	None	Always
Delete a File	173	AD	i	Byte, Short	None	Always
Get Filesystem Space	175	AF	»	None	Integer	Never
Get Filesystem Directory	179	B3		None	Byte[][8]	Never
Filesystem Upload	176	B0	⋮	Integer, Byte[]	None	Always
Filesystem Download	48	30	0	None	Integer, Byte[]	Never
File Download	178	B2	⋮	Byte, Short	Integer, Byte[]	Never
File Move	180	B4	┆	Byte, Integer, Byte, Integer	None	Always
XModem Filesystem Upload	219, 133, 6, 48	DB, 85, 6, 30	␣, à, ACK, 0	Short, Byte, Integer, Byte[]	None	Always
XModem Filesystem Download	222, 133, 6, 48	DE, 85, 6, 30	␣, à, ACK, 0	None	Integer, Byte[]	Never
XModem File Upload	220, 133, 6, 48	DC, 85, 6, 30	␣, à, ACK, 0	Short, Byte, Integer, Byte[]	None	Always
XModem File Download	221, 133, 6, 48	DD, 85, 6, 30	␣, à, ACK, 0	Short, Byte	Integer, Byte[]	Never

Table 62: Data Security Command Summary

Name	Dec	Hex	ASCII	Parameters	Response	Remembered
Set Remember	147	93	ô	Byte	None	Always
Set Data Lock	202, 245, 160	CA, F5, A0	␣,], á	Byte	None	Remember On
Set and Save Data Lock	203, 245, 160	CB, F5, A0	␣,], á	Byte	None	Always

Table 63: Miscellaneous Command Summary

Name	Dec	Hex	ASCII	Parameters	Response	Remembered
Write Customer Data	52	34	4	Byte[16]	None	Always
Read Customer Data	53	35	5	None	Byte[16]	Never
Write to Scratchpad	204	CC	␣	Byte, Short, Byte[]	None	Never
Read from Scratchpad	205	CD	=	Byte, Short	Byte[]	Never
Read Version Number	54	36	6	None	Byte	Never
Read Module Type	55	37	7	None	Byte	Never
Read Screen	184	B8	␣	None	Byte, Byte, Byte[]	Never



7.2 Block Diagram

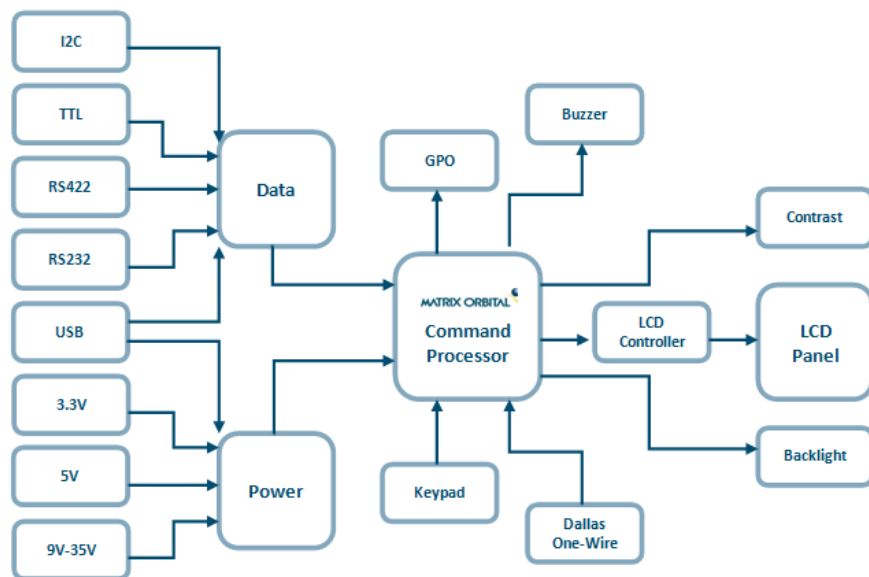

Figure 22: Functional Diagram

7.3 Environmental Specifications

Table 64: Environmental Limits

	Standard	Extended (-E)
Operating Temperature	0°C to +50°C	-20°C to +70°C
Storage Temperature	-10°C to +60°C	-30°C to +80°C
Operating Relative Humidity	Maximum 90% non-condensing	

7.4 Electrical Tolerances

Current Consumption

Table 65: Current Consumption

Board	+	Backlight	+	Keypad	+	LEDs	+	GPOs
165mA		45mA – 65mA		10mA		10mA each		20mA each max

Table 66: Backlight Current Draw

YG	GW & WB	TCI
50mA	45mA	65mA

Input Voltage Specifications

Table 67: Voltage Specifications

Low Voltage (-LV)	Standard	Extended Wide Voltage (-VPT)
3.3V	4.75-5.25V	9.0-35.0V



7.5 Dimensional Drawings

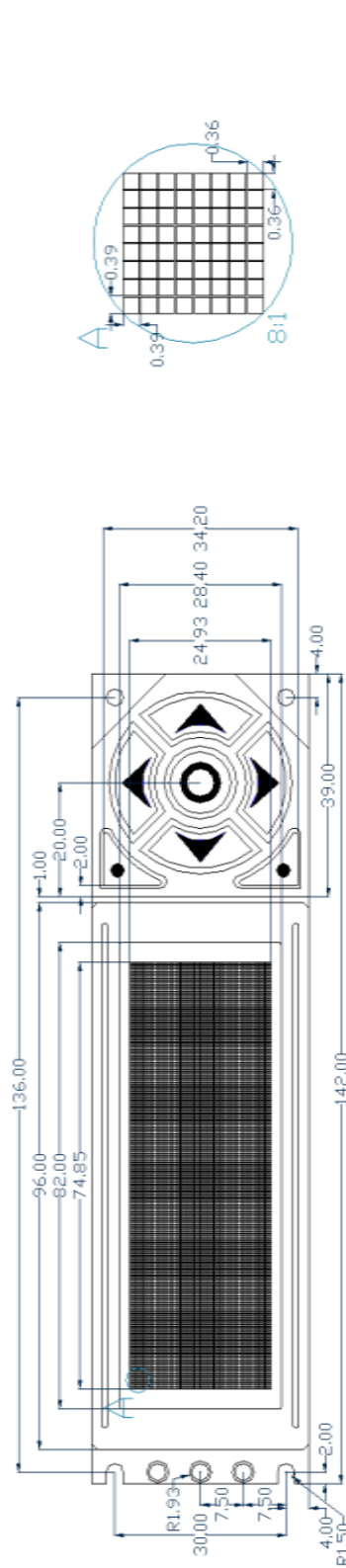

Figure 23: Display Dimensional Drawing

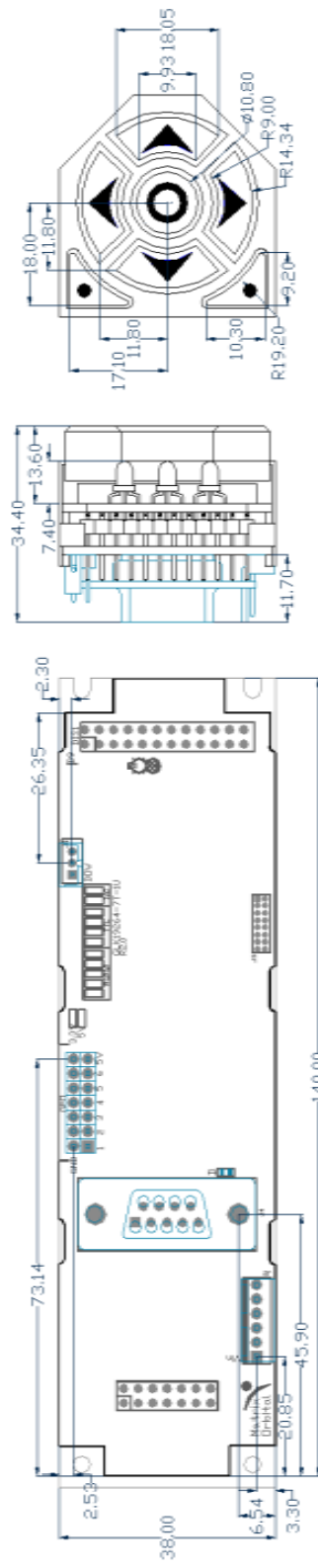

Figure 24: Standard Model Dimensional Drawing



7.1 Optical Characteristics

Table 68: Display Optics

Module Size	112.00 x 38.00 x 28.9	mm
Viewing Area	98.0 x 28.4	mm
Active Area	93.57 x 24.93	mm
Pixel Size	0.36 x 0.36	mm
Pixel Pitch	0.39 x 0.39	mm
Viewing Direction	12	O'clock
Viewing Angle	-30 to +30	°
Contrast Ratio	3	
Backlight Half-Life	20,000	Hours

***Note:** Backlight half-life is rated for normal operating conditions only: 25±10°C and 45±20% Relative Humidity.

8 Ordering

8.1 Part Numbering Scheme

Table 69: Part Numbering Scheme

GLK	19264	-7T	-1U	-USB	-FGW	-E
1	2	3	4	5	6	7
						8

8.2 Options

Table 70: Display Options

#	Designator	Options
1	Product Type	GLK: Graphic Liquid Crystal Display with Keypad Input
2	Display Size	19264: 192 pixel columns by 64 rows
3	Keypad Size	-7T: 7 tactile keys
4	Form Factor	-1U: Designed to 1U, or PC bay insert, dimensions
5	Protocol	*NP: Standard Model -USB: USB Only Model -422: RS422 Only Model**
6	Colour	-YG: Grey Text with Yellow-Green Background -FGW: Grey Text with White Background -WB: White Text with Blue Background -TCI: Tricolour Text with Black Background
7	Voltage	*NP: Standard Voltage -LV: Low Voltage -VPT: Wide Voltage with Efficient Switching Power Supply
8	Temperature	*NP: Standard -E: Extended Temperature

***Note:** NP means No Populate; skip this designator in the part number and move to the next option.

****Note:** The RS422 model should only be powered from a local source, unless the -VPT variant is used.



8.3 Accessories





Power

Table 71: Power Accessories

PCS	Standard Power Cable	
-----	----------------------	---

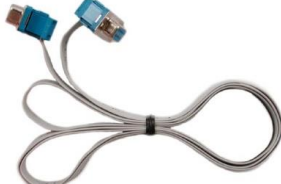
Communication

Table 72: Communication Accessories

CSS4FT	1 ft. Serial Cable	
CSS4FT	4 ft. Serial Cable	
EXTMUSB3FT	Mini-USB Cable	
INTMUSB3FT	Internal Mini-USB Cable	
ESCCPC5V	Extended Serial Communication/5V Power Cable	
BBC	Breadboard Cable	



Peripherals

Table 73: Peripheral Accessories

Temperature Probe	Dallas One-Wire Temperature Probe	
-------------------	-----------------------------------	---

Mounting

Table 74: Mounting Accessories

B19264-BK	19264-1U Black Mounting Bracket	
-----------	---------------------------------	---



9 Definitions

ASCII: American standard code for information interchange used to give standardized numeric codes to alphanumeric characters.

BPS: Bits per second, a measure of transmission speed.

Byte: An unsigned data packet that is eight bits long.

DOW: Dallas One-Wire protocol, similar to I²C, provides reduced data rates at a greater distance. One wire carries data, while two others supply power and ground. Matrix Orbital tests non-parasitic devices only, those that do not draw power from the data line; however, some parasitic devices may work.

GPO: General purpose output, used to control peripheral devices from a display.

GUI: Graphical user interface.

Hexadecimal: A base 16 number system utilizing symbols 0 through F to represent the values 0-15.

I²C: Inter-integrated circuit protocol uses clock and data lines to communicate short distances at slow speeds from a master to up to 128 addressable slave devices. A display is a slave device.

Integer: An unsigned data packet that is thirty-two bits long, in little Endian format.

LSB: Least significant bit or byte in a transmission, the rightmost when read.

MSB: Most significant bit or byte in a transmission, the leftmost when read.

RS232: Recommended standard 232, a common serial protocol. A low level is -30V, a high is +30V.

RS422: Recommended standard 422, a more robust differential pair serial protocol.

SDA: Serial data line used to transfer data in I²C protocol. This open drain line should be pulled high through a resistor. Nominal values are between 1K and 10K Ω.

SCL: Serial clock line used to designate data bits in I²C protocol. This open drain line should be pulled high through a resistor. Nominal values are between 1K and 10K Ω.

Short: An unsigned data packet that is sixteen bits long, in little Endian format.

TTL: Transistor-transistor logic applied to serial protocol. Low level is 0V while high logic is 5V.

10 Contact

Sales

Phone: 403.229.2737

Email: sales@matrixorbital.ca

Support

Phone: 403.204.3750

Email: support@matrixorbital.ca

Online

Purchasing: www.matrixorbital.com

Support: www.matrixorbital.ca

