

LAURA-SS-PIN

~11° smooth spot beam optimized for CREE XP-E. Assembly with white holder, installation tape and location pins.

TECHNICAL SPECIFICATIONS:

Dimensions	21.6 mm
Height	13.1 mm
Fastening	tape, pin
ROHS compliant	yes 

MATERIAL SPECIFICATIONS:

Component	Type	Material	Colour	Finish
LAURA-SS	Single lens	PMMA		
LAURA-PIN-XP-HLD-WHT	Holder	PC	white	
ROSE-TAPE	Tape	PU tape	black	

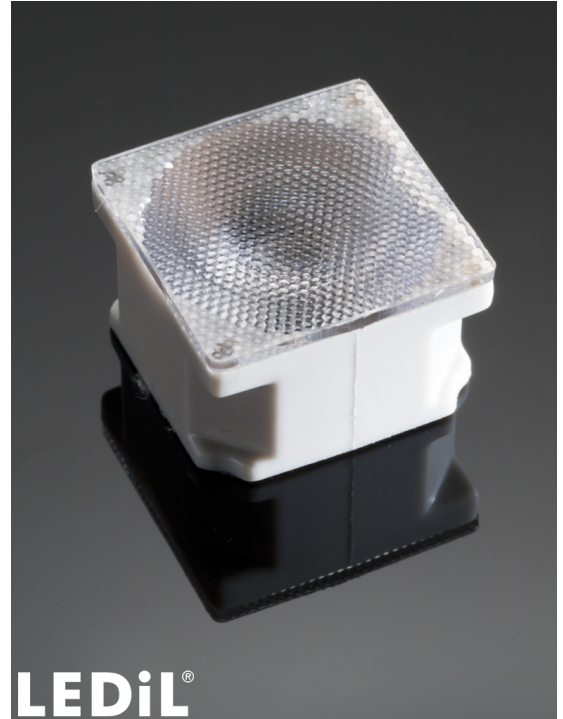

ORDERING INFORMATION:

Component		Qty in box	MOQ	MPQ	Box weight (kg)
CA12011_LAURA-SS-PIN	Single lens	1440		180	7.5
» Box size:					

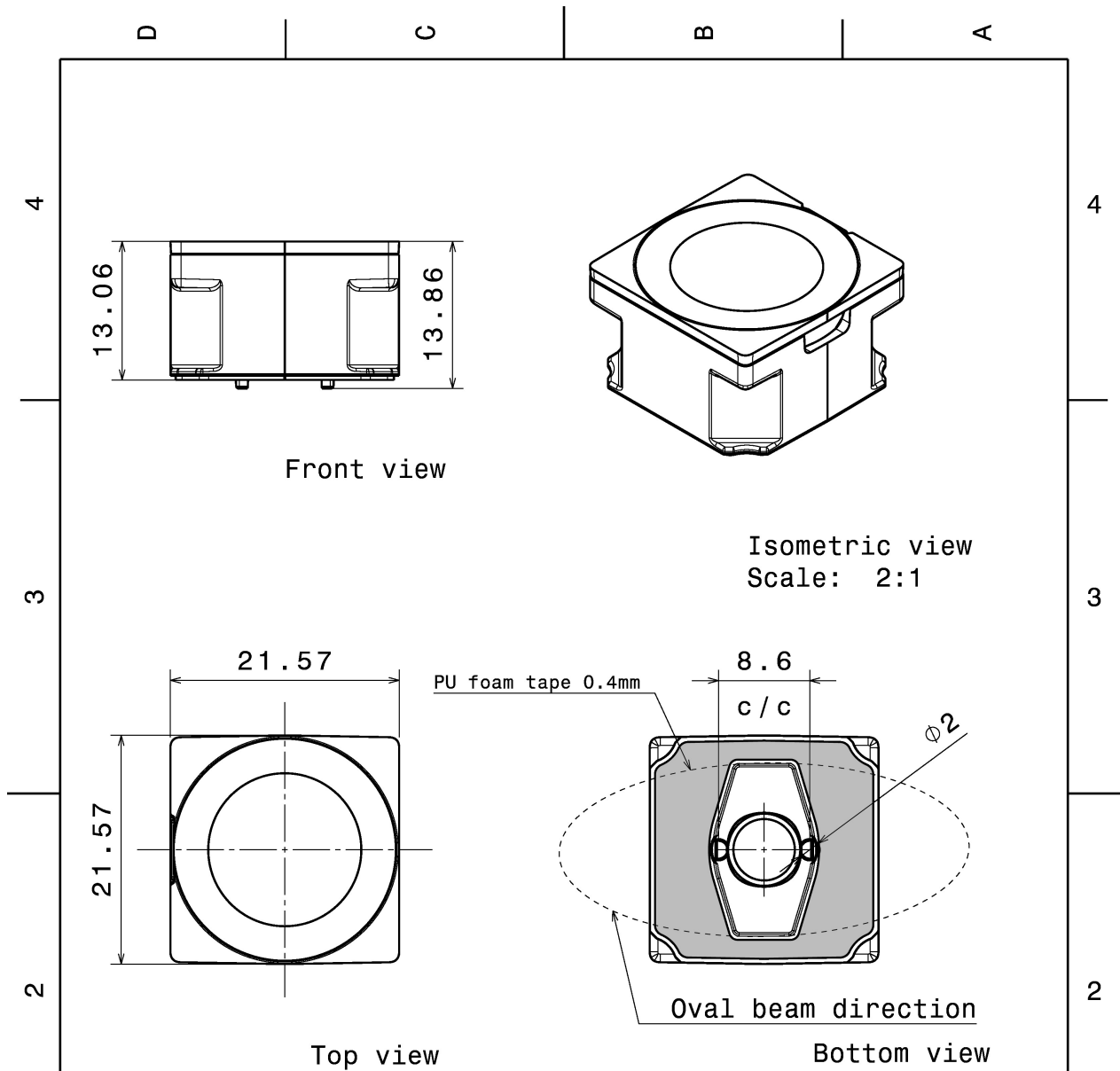

INDEX	PART NO	DESCRIPTION	MATERIAL	COLOUR
1	-	Laura-mech	PMMA	
3	C11835	LAURA-PIN-XP-HLD-WHT	PC	white

Tolerances if not otherwise shown
According to DIN ISO 2768-1
Linear measures:
Up to 30mm class M, otherwise class C.
According to DIN ISO 2768-2
Form and position: class L

LEDiL

Ledil Oy
Salorankatu 10
FIN 24240 SALO
Finland

THIRD ANGLE PROJECTION:

DRAWING TITLE

LAURA-XP-PIN-WHT assembly

This drawing is the property of LEDiL Oy. It may not be reproduced, copied or communicated without a written agreement with LEDiL Oy.

SIZE PART NUMBER

A4

SCALE 2:1

WEIGHT 9 g

SHEET 1/1

PHOTOMETRIC DATA (MEASURED):

CREE

LED XB-D
FWHM 11.0°
Efficiency 93 %
Peak intensity 14.4 cd/lm
LEDs/each optic 1
Light colour White
Required components:

CREE

LED XP-E
FWHM 11.0°
Efficiency 93 %
Peak intensity 16.5 cd/lm
LEDs/each optic 1
Light colour White
Required components:

CREE

LED XP-E-HEW
FWHM 12.0°
Efficiency 92 %
Peak intensity 11.7 cd/lm
LEDs/each optic 1
Light colour White
Required components:

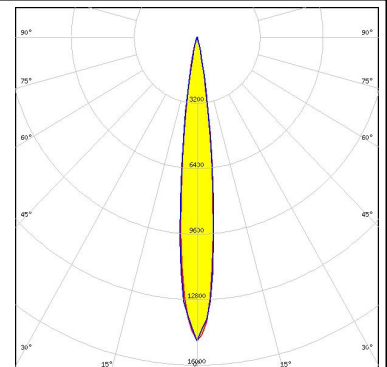

CREE

LED XP-G
FWHM 12.0°
Efficiency 94 %
LEDs/each optic 1
Light colour White
Required components:

PHOTOMETRIC DATA (MEASURED):

LUMILEDS

LED LUXEON T
 FWHM 13.0°
 Efficiency 92 %
 Peak intensity 12.2 cd/Im
 LEDs/each optic 1
 Light colour White
 Required components:

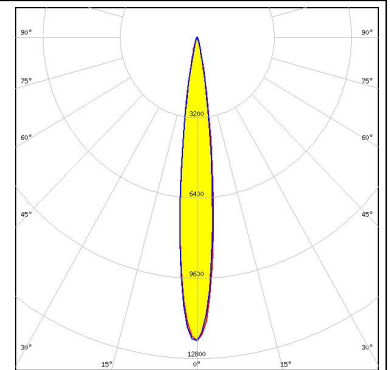

LUMILEDS

LED LUXEON Z ES
 FWHM 12.0°
 Efficiency 92 %
 Peak intensity 17.6 cd/Im
 LEDs/each optic 1
 Light colour White
 Required components:

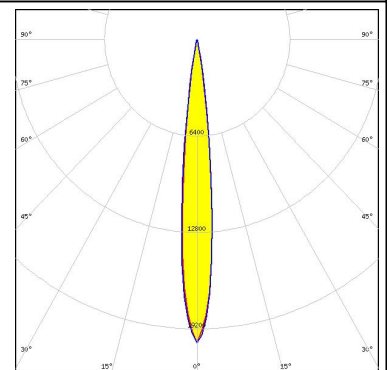

NICHIA

LED NCSxx19B
 FWHM 13.0°
 Efficiency 91 %
 Peak intensity 13.5 cd/Im
 LEDs/each optic 1
 Light colour White
 Required components:

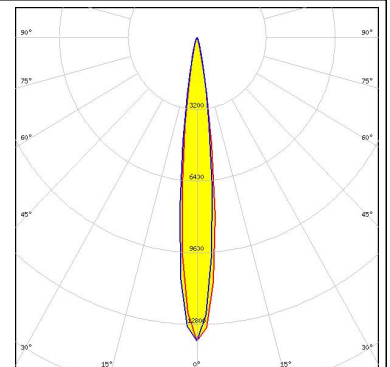
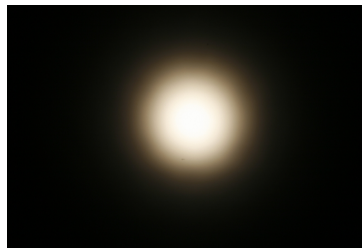

NICHIA

LED NF2x757D
 FWHM 14.0°
 Efficiency 91 %
 Peak intensity 11.7 cd/Im
 LEDs/each optic 1
 Light colour White
 Required components:

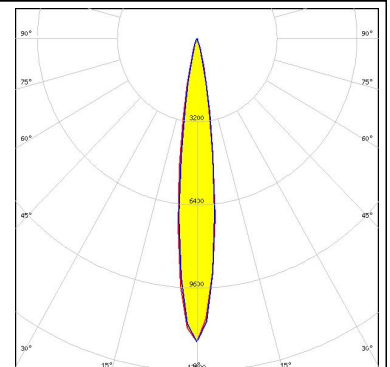

PHOTOMETRIC DATA (MEASURED):

OSRAM
Opto Semiconductors

LED OSLON Square EC
FWHM 13.0°
Efficiency 88 %
Peak intensity 9.1 cd/lm
LEDs/each optic 1
Light colour White
Required components:

OSRAM
Opto Semiconductors

LED OSLON SSL 150
FWHM 11.0°
Efficiency 91 %
Peak intensity 12.5 cd/lm
LEDs/each optic 1
Light colour White
Required components:

OSRAM
Opto Semiconductors

LED OSLON SSL 80
FWHM 11.0°
Efficiency 91 %
Peak intensity 13.5 cd/lm
LEDs/each optic 1
Light colour White
Required components:

OSRAM
Opto Semiconductors

LED SFH 4725S
FWHM 14.0°
Efficiency %
LEDs/each optic 1
Light colour White
Required components:

PHOTOMETRIC DATA (MEASURED):

	
SEOUL SEMICONDUCTOR	
LED	Z5
FWHM	10.0°
Efficiency	%
LEDs/each optic	1
Light colour	White
Required components:	

PHOTOMETRIC DATA (SIMULATED):



LED XP-G3
 FWHM Asymmetric
 Efficiency 93 %
 Peak intensity 11.1 cd/lm
 LEDs/each optic 1
 Light colour White
 Required components:

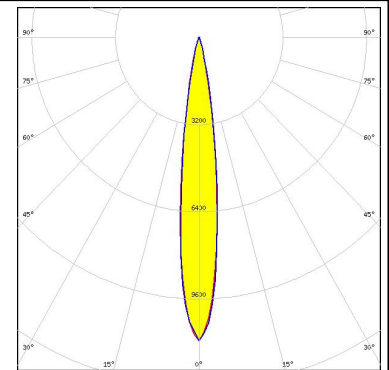
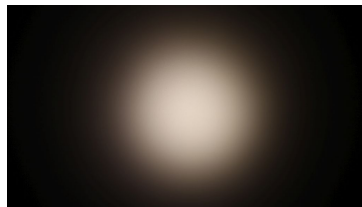

LED LUXEON IR Domed 150
 FWHM 14.0°
 Efficiency 0 %
 LEDs/each optic 1
 Light colour White
 Required components:



LED LUXEON IR Domed 60
 FWHM 12.0°
 Efficiency 94 %
 LEDs/each optic 1
 Light colour White
 Required components:



LED LUXEON IR Domed 90
 FWHM 12.0°
 Efficiency 94 %
 LEDs/each optic 1
 Light colour White
 Required components:

PHOTOMETRIC DATA (SIMULATED):

OSRAM Opto Semiconductors

LED OSLON Square CSSRM2/CSSRM3
FWHM 12.0°
Efficiency 96 %
Peak intensity 15.7 cd/lm
LEDs/each optic 1
Light colour White
Required components:

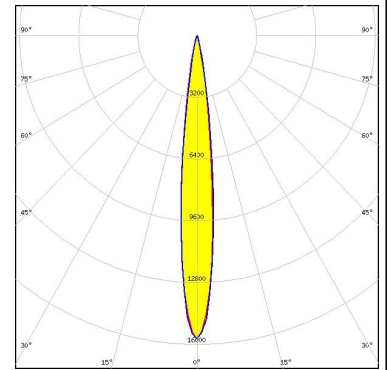

OSRAM Opto Semiconductors

LED OSLON Square PC
FWHM 12.0°
Efficiency %
LEDs/each optic 1
Light colour White
Required components:

OSRAM Opto Semiconductors

LED SFH 4170S
FWHM 12.0°
Efficiency 88 %
LEDs/each optic 1
Light colour IR
Required components:

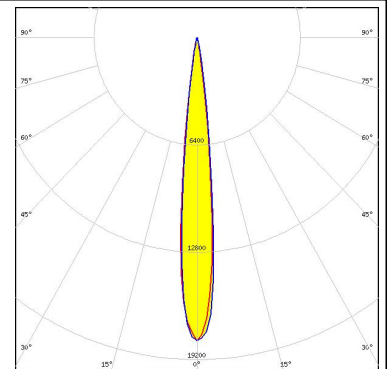

OSRAM Opto Semiconductors

LED SFH 4715S
FWHM 12.0°
Efficiency %
LEDs/each optic 1
Light colour White
Required components:

GENERAL INFORMATION:

NOTE: The typical beam angle will be changed by different color, chip size and chip position tolerance. The typical total beam angle is the full angle measured where the luminous intensity is half of the peak value.

MATERIALS:

As part of our continuous research and improvement processes, and to ensure the best possible quality and availability of our products, LEDiL reserves the right to change material grades without notice.

PRODUCT DATA USER AGREEMENT AND DISCLAIMER:

The measured data in the provided downloadable LEDiL Product Datasheets and Mechanical 2D-Drawings is rounded and provided as reference for planning. LEDiL Oy's optical specifications have been verified by conducting performance testing of the products in accordance with the company's quality system. The reported data are averaged results of multiple measurements with typical variation. LEDiL Oy reserves the right to without prior notification make changes and improvements to its products.

LEDiL Oy assumes neither warranty, nor guarantee nor any other liability of any kind for the contents and correctness of the provided data. The provided data has been generated with highest diligence but the provided data may in reality not represent the complete possible variation range of all intrinsic parameters. Therefore, in certain cases a deviation from the provided data could occur.

LEDiL Oy reserves the right to undertake technical changes of its products without further notification which could lead to changes in the provided data. LEDiL Oy assumes no liability of any kind for the possible deviation from any provided data or any other damage resulting from the usage of the provided data.

The user agrees to this disclaimer and user agreement with the download or usage of the provided files.

LEDiL Oy

Joensuunkatu 13
FI-24240 SALO
Finland

LEDiL Inc.

228 West Page Street
Suite D
Sycamore IL 60178
USA

Local sales and technical support

[www.ledil.com/
where_to_buy](http://www.ledil.com/where_to_buy)

Shipping locations

Salo, Finland
Hong Kong, China

Distribution Partners

[www.ledil.com/
where_to_buy](http://www.ledil.com/where_to_buy)