

10 A Snubberless™, logic level and standard Triacs

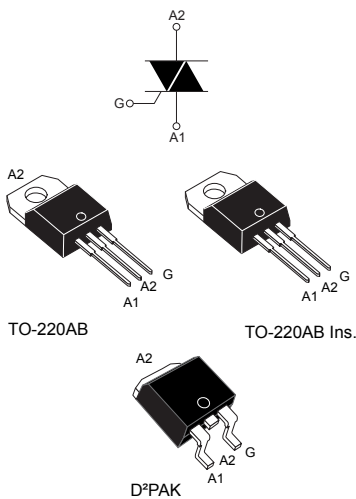

Features

- Medium current Triac
- Low thermal resistance with clip bonding
- Low thermal resistance insulation ceramic for insulated BTA
- High commutation (4Q) or very high commutation (3Q, Snubberless™) capability
- BTA series UL1557 certified (file ref: 81734)
- Packages are RoHS (2002/95/EC) compliant

Description

Available either in through-hole or surface mount packages, the BTA10, BTB10 and T10xx Triac series are suitable for general purpose mains power AC switching. They can be used as ON/OFF function in applications such as static relays, heating regulation or induction motor starting circuit. They are also recommended for phase control operations in light dimmers and appliance motors speed controllers.

The Snubberless™ versions (W suffix and T10xx) are especially recommended for use on inductive loads, because of their high commutation performance. By using an internal ceramic pad, the Snubberless™ series provide an insulated tab (rated at 2500 V_{RMS}) complying with UL standards (file reference: E81734).

Product status link

[BTA10, BTB10, T1035, T1050](#)

Product summary

I_{T(RMS)}	10 A
V_{DRM}/V_RRM	600 and 800 V
I_{GT}	25 to 50 mA

1 Characteristics

Table 1. Absolute maximum ratings

Symbol	Parameters			Value	Unit	
$I_{T(RMS)}$	RMS on-state current (full sine wave)	TO-220AB	$T_c = 105\text{ }^\circ\text{C}$	10	A	
		TO-220AB Ins.	$T_c = 95\text{ }^\circ\text{C}$			
I_{TSM}	Non repetitive surge peak on-state current (full cycle, T_j initial = $25\text{ }^\circ\text{C}$)	F = 50 Hz	$t_p = 20\text{ ms}$	100	A	
		F = 60 Hz	$t_p = 16.7\text{ ms}$	105		
I^2t	I^2t value for fusing	$t_p = 10\text{ ms}$		55	A^2s	
di/dt	Critical rate of rise of on-state current $I_G = 2 \times I_{GT}$, $t_r \leq 100\text{ ns}$	F = 120 Hz	$T_j = 125\text{ }^\circ\text{C}$	50	$\text{A}/\mu\text{s}$	
V_{DSM}/V_{RSM}	Non repetitive surge peak off-state voltage	$t_p = 10\text{ ms}$	$T_j = 25\text{ }^\circ\text{C}$	$V_{DRM}/V_{RRM} + 100$	V	
I_{GM}	Peak gate current	$t_p = 20\text{ }\mu\text{s}$	$T_j = 125\text{ }^\circ\text{C}$	4	A	
$P_{G(AV)}$	Average gate power dissipation	$T_j = 125\text{ }^\circ\text{C}$		1	W	
T_{stg}	Storage junction temperature range				-40 to +150	$^\circ\text{C}$
T_j	Operating junction temperature range				-40 to +125	$^\circ\text{C}$

Table 2. Static electrical characteristics

Symbol	Test conditions	T_j		Value	Unit
$V_T^{(1)}$	$I_{TM} = 14\text{ A}$, $t_p = 380\text{ }\mu\text{s}$	$25\text{ }^\circ\text{C}$	Max.	1.55	V
V_{TO}	threshold on-state voltage	$125\text{ }^\circ\text{C}$	Max.	0.85	V
R_D	Dynamic resistance	$125\text{ }^\circ\text{C}$	Max.	40	$\text{m}\Omega$
I_{DRM}/I_{RRM}	$V_{DRM} = V_{RRM}$	$25\text{ }^\circ\text{C}$	Max.	5	μA
		$125\text{ }^\circ\text{C}$		1	mA

1. For both polarities of A2 referenced to A1

Table 3. Electrical characteristics ($T_j = 25\text{ }^\circ\text{C}$, unless otherwise specified) - Snubberless™ (3 quadrants)

Symbol	Parameters	Quadrant		T1035	BTA10-xCW BTB10-xCW	T1050 BTA10-xBW BTB10-xBW	Unit
I_{GT}	$V_D = 12\text{ V}$, $R_L = 33\text{ }\Omega$	I - II - III	Max.	35		50	mA
V_{GT}		I - II - III	Max.	1.3			V
V_{GD}	$V_D = V_{DRM}$, $R_L = 3,3\text{ k}\Omega$, $T_j = 125\text{ }^\circ\text{C}$	I - II - III	Min.	0.2			V
I_H	$I_T = 500\text{ mA}$	I - II - III	Max.	35		50	mA
I_L	$I_G = 1.2 I_{GT}$	I - III	Max.	50		70	mA
		II	Max.	80	60	80	
$dV/dt^{(2)}$	$V_D = 67\text{ \% } V_{DRM}$ gate open, $T_j = 125\text{ }^\circ\text{C}$		Min.	500		1000	$\text{V}/\mu\text{s}$

Symbol	Parameters	Quadrant		T1035	BTA10-xCW BTB10-xCW	T1050 BTA10-xBW BTB10-xBW	Unit
$(di/dt)_c^{(2)}$	Without snubber, $T_j = 125\text{ °C}$		Min.	5.5		9	A/ms

1. Minimum I_{GT} is guaranteed at 5 % of I_{GT} max.
2. For both polarities of A2 referenced to A1

Table 4. Electrical characteristics ($T_j = 25\text{ °C}$, unless otherwise specified) - standard Triac (4 quadrants)

Symbol	Parameters	Quadrant		Value		Unit
				C	B	
$I_{GT}^{(1)}$	$V_D = 12\text{ V}$, $R_L = 33\ \Omega$	I - II - III	Max.	25	50	mA
		IV	Max.	50	100	
V_{GT}		All	Max.	1.3		V
V_{GD}	$V_D = V_{DRM}$, $R_L = 3,3\text{ k}\Omega$, $T_j = 125\text{ °C}$	I - II - III	Min.	0.2		V
$I_H^{(2)}$	$I_T = 500\text{ mA}$	I - II - III	Max.	25	50	mA
I_L	$I_G = 1.2\ I_{GT}$	I - III	Max.	40	50	mA
		II	Max.	80	100	
$dV/dt^{(2)}$	$V_D = 67\ %\ V_{DRM}$ gate open, $T_j = 125\text{ °C}$		Min.	200	400	V/ μ s
$(dV/dt)_c^{(2)}$	$(di/dt)_c = 4.4\text{ A/ms}$, $T_j = 125\text{ °C}$		Min.	5	10	V/ μ s

1. Minimum I_{GT} is guaranteed at 5 % of I_{GT} max.
2. For both polarities of A2 referenced to A1

Table 5. Thermal resistance

Symbol	Parameters	Value	Unit
$R_{th(j-c)}$ (typ.)	Junction to case (AC)	TO-220AB / D ² PAK	1.5
		TO-220AB insulated	2.4
$R_{th(j-a)}$ (max.)	Junction to ambient ($S^{(1)} = 2\text{ cm}^2$)	D ² PAK	45
	Junction to ambient	TO-220AB / TO-220AB ins	60

1. Copper surface under tab.

1.1 Characteristics (curves)
Figure 2. Maximum power dissipation versus on-state RMS current (full cycle)

Figure 3. RMS on-state current cycle versus case temperature (full cycle)

Figure 4. Relative variation of thermal impedance versus pulse duration

Figure 5. On-state characteristics (maximum values)

Figure 6. Surge peak on-state current versus number of cycles

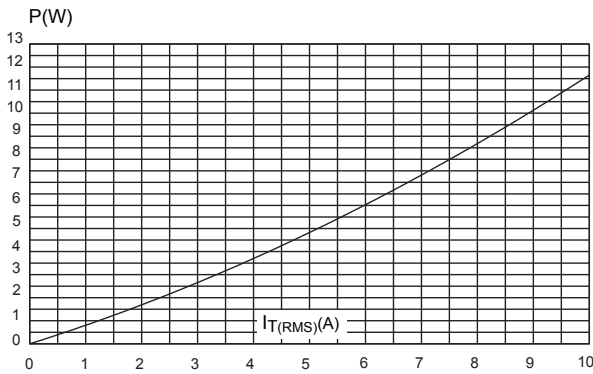
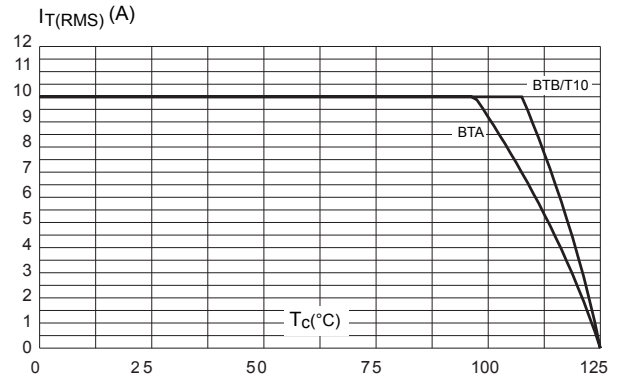
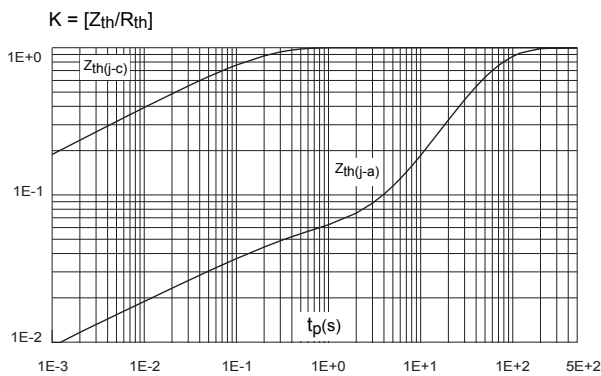
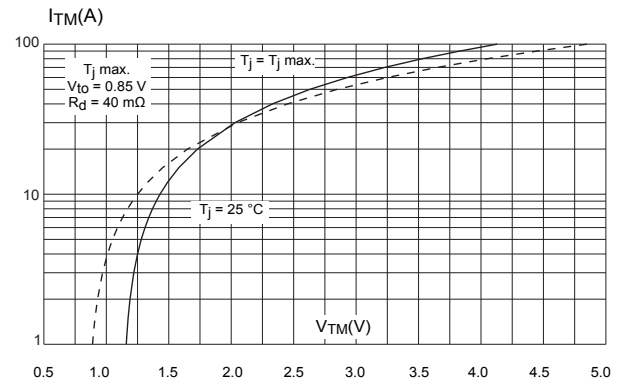
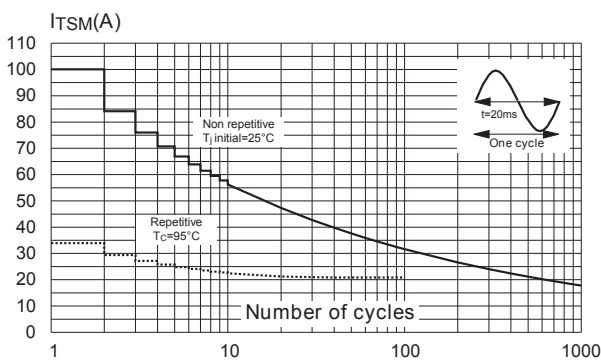
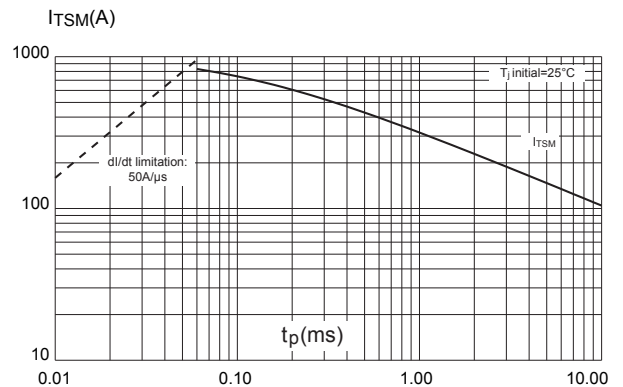
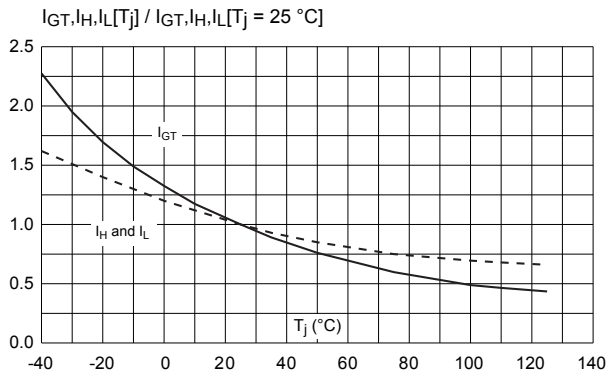
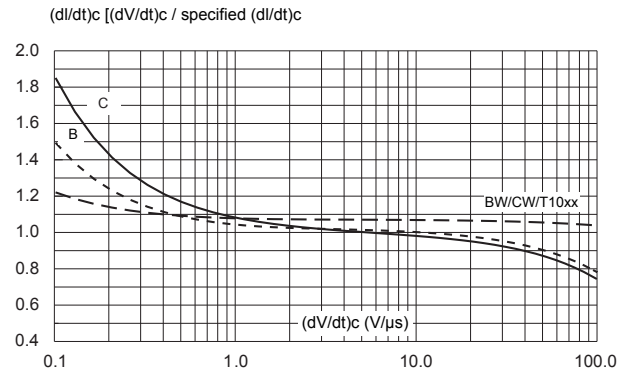
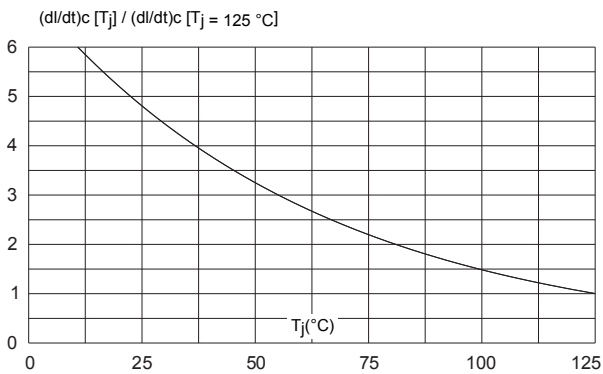
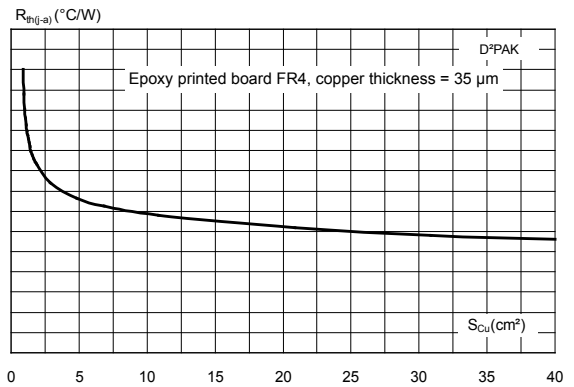
Figure 7. Non repetitive surge peak on-state current versus sinusoidal pulse width (tp < 10 ms)

Figure 8. Relative variation of gate trigger current, holding current and latching current versus junction temperature (typical values)

Figure 9. Relative variation of critical rate of decrease of main current versus $(dV/dt)_c$ (typical values)

Figure 10. Relative variation of critical rate of decrease of main current versus junction temperature

Figure 11. D²PAK thermal resistance junction to ambient versus copper surface under tab

2 Package information

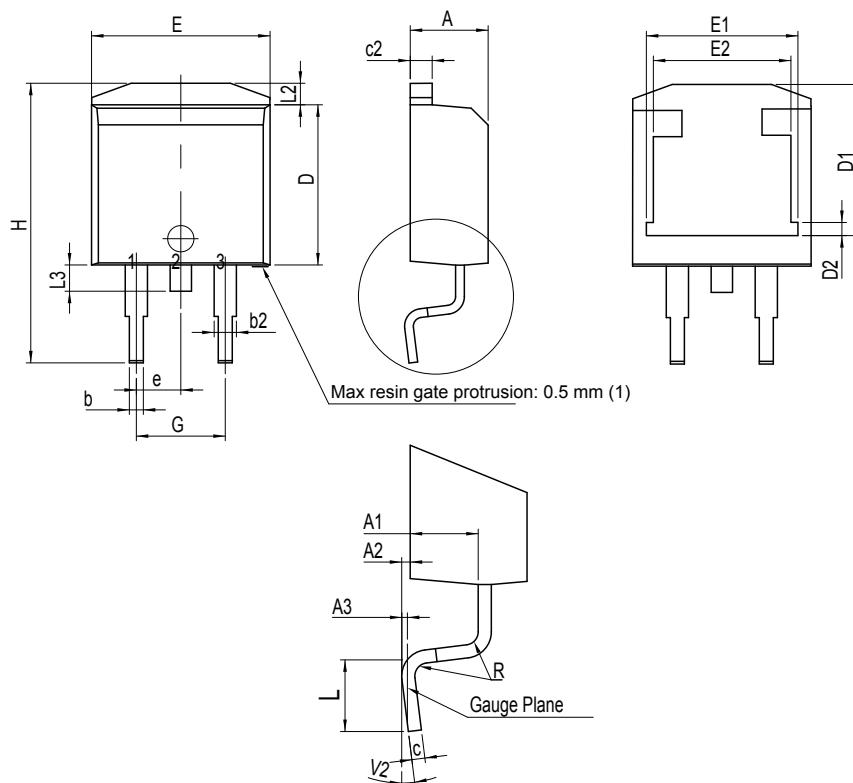
In order to meet environmental requirements, ST offers these devices in different grades of **ECOPACK®** packages, depending on their level of environmental compliance. ECOPACK® specifications, grade definitions and product status are available at: www.st.com. ECOPACK® is an ST trademark.

2.1 D²PAK package information

Figure 12. D²PAK package outline



(1) Resin gate is accepted in each of position shown on the drawing, or their symmetrical.

Table 6. D²PAK package mechanical data

Ref.	Dimensions					
	Millimeters			Inches ⁽¹⁾		
	Min.	Typ.	Max.	Min.	Typ.	Max.
A	4.30		4.60	0.1693		0.1811
A1	2.49		2.69	0.0980		0.1059
A2	0.03		0.23	0.0012		0.0091
A3		0.25			0.0098	
b	0.70		0.93	0.0276		0.0366
b2	1.25		1.7	0.0492		0.0669

Ref.	Dimensions					
	Millimeters			Inches ⁽¹⁾		
	Min.	Typ.	Max.	Min.	Typ.	Max.
c	0.45		0.60	0.0177		0.0236
c2	1.21		1.36	0.0476		0.0535
D	8.95		9.35	0.3524		0.3681
D1	7.50		8.00	0.2953		0.3150
D2	1.30		1.70	0.0512		0.0669
e	2.54			0.1		
E	10.00		10.28	0.3937		0.4047
E1	8.30		8.70	0.3268		0.3425
E2	6.85		7.25	0.2697		0.2854
G	4.88		5.28	0.1921		0.2079
H	15		15.85	0.5906		0.6240
L	1.78		2.28	0.0701		0.0898
L2	1.27		1.40	0.0500		0.0551
L3	1.40		1.75	0.0551		0.0689
R		0.40			0.0157	
V2	0°		8°	0°		8°

1. Dimensions in inches are given for reference only

Figure 13. D²PAK recommended footprint (dimensions are in mm)

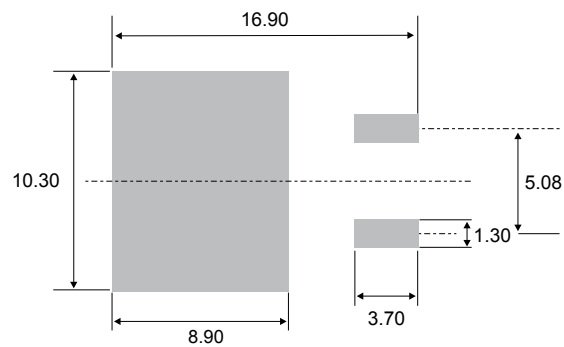

2.2 TO-220AB non ins. and insulated package information

Figure 14. TO-220AB non ins. and insulated package outline

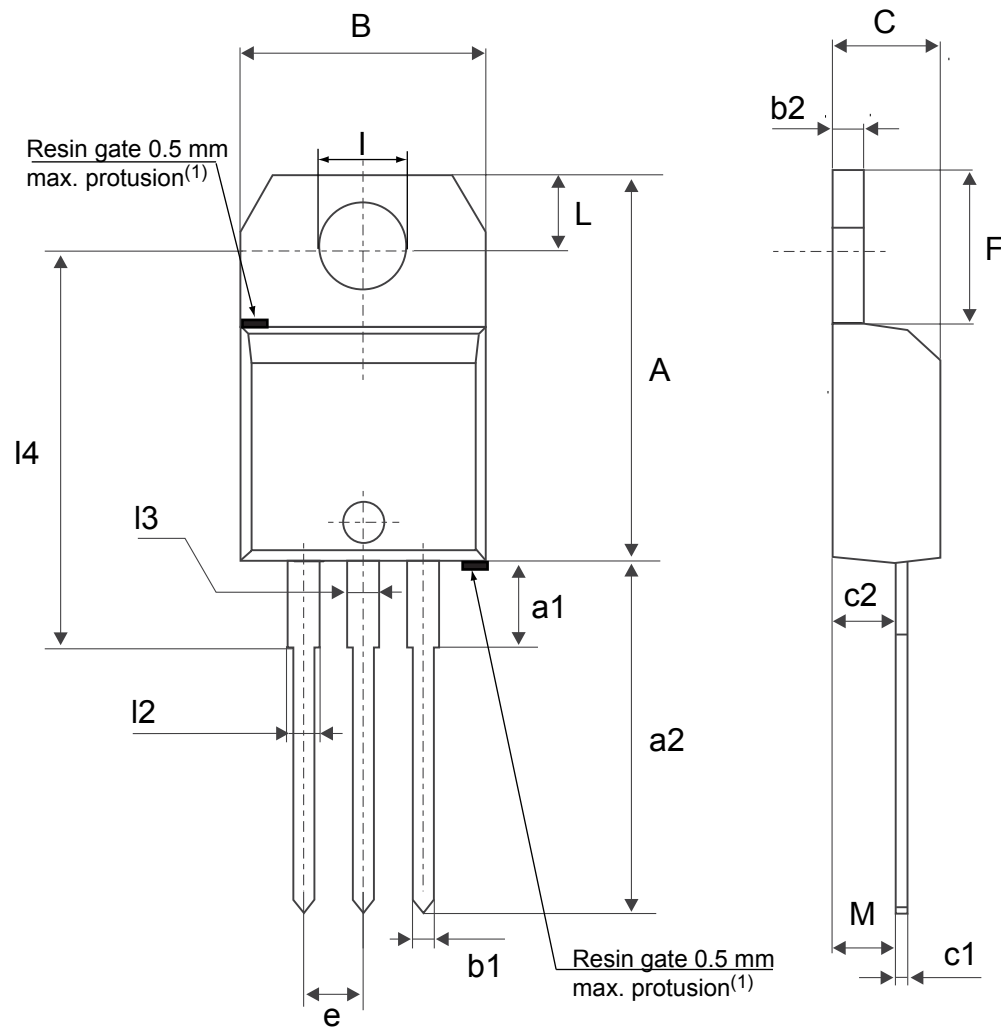

(1)Resin gate position accepted in one of the two positions or in the symmetrical opposites.

Table 7. TO-220AB non ins. and insulated package mechanical data

Ref.	Dimensions					
	Millimeters			Inches ¹		
	Min.	Typ.	Max.	Min.	Typ.	Max.
A	15.20		15.90	0.5984		0.6260
a1		3.75			0.1476	
a2	13.00		14.00	0.5118		0.5512
B	10.00		10.40	0.3937		0.4094
b1	0.61		0.88	0.0240		0.0346
b2	1.23		1.32	0.0484		0.0520
C	4.40		4.60	0.1732		0.1811

Ref.	Dimensions					
	Millimeters			Inches ¹		
	Min.	Typ.	Max.	Min.	Typ.	Max.
c1	0.49		0.70	0.0193		0.0276
c2	2.40		2.72	0.0945		0.1071
e	2.40		2.70	0.0945		0.1063
F	6.20		6.60	0.2441		0.2598
l	3.73		3.88	0.1469		0.1528
L	2.65		2.95	0.1043		0.1161
l2	1.14		1.70	0.0449		0.0669
l3	1.14		1.70	0.0449		0.0669
l4	15.80	16.40	16.80	0.6220	0.6457	0.6614
M		2.6			0.1024	

1. Inch dimensions are for reference only.

3 Ordering information

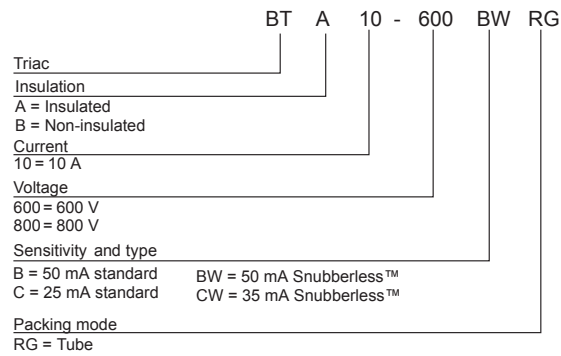
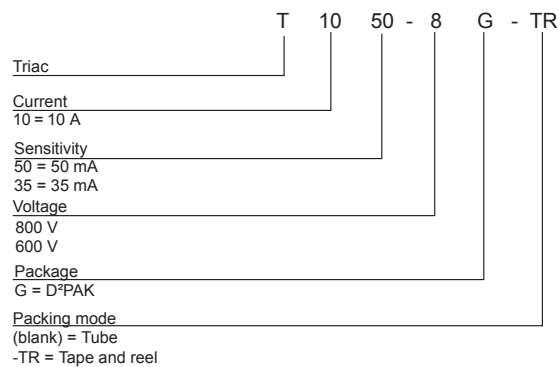
Figure 15. BTA10 and BTB10 series ordering information scheme

Figure 16. T10xx series ordering information scheme

Table 8. Ordering information

Order code	Marking	Package	Weight	Base qty.	Delivery mode
BTA10-600BRG	BTA10-600B	TO-220AB Ins.	2.3 g	50	Tube
BTA10-600CRG	BTA10-600C				
BTA10-600BWRG	BTA10-600BW				
BTA10-600CWRG	BTA10-600CW				
BTA10-800BWRG	BTA10-800BW				
BTA10-800CWRG	BTA10-800CW				
BTB10-600BWRG	BTB10-600BW	TO-220AB			
BTB10-800BWRG	BTB10-800BW				
T1035-6G	T1035-6G	D ² PAK	1.50 g		Tape and reel 13"
T1050-8G	T1050-8G				
T1035-6G-TR	T1035-6G			1000	
T1050-8G-TR	T1050-8G				

Revision history

Table 9. Document revision history

Date	Revision	Changes
Sep-2002	5A	Last update.
13-Feb-2006	6	TO-220AB delivery mode changed from bulk to tube. ECOPACK statement added.
06-Feb-2017	7	Added D ² PAK package information.
15-Mar-2018	8	Updated Table 3. Electrical characteristics (T _J = 25 °C, unless otherwise specified) - Snubberless™ (3 quadrants), Section 3 Ordering information and Section 2.1 D ² PAK package information. Added RPNs T1035 and T1050.
01-Mar-2019	9	Updated Links syntax.

IMPORTANT NOTICE – PLEASE READ CAREFULLY

STMicroelectronics NV and its subsidiaries (“ST”) reserve the right to make changes, corrections, enhancements, modifications, and improvements to ST products and/or to this document at any time without notice. Purchasers should obtain the latest relevant information on ST products before placing orders. ST products are sold pursuant to ST’s terms and conditions of sale in place at the time of order acknowledgement.

Purchasers are solely responsible for the choice, selection, and use of ST products and ST assumes no liability for application assistance or the design of Purchasers’ products.

No license, express or implied, to any intellectual property right is granted by ST herein.

Resale of ST products with provisions different from the information set forth herein shall void any warranty granted by ST for such product.

ST and the ST logo are trademarks of ST. All other product or service names are the property of their respective owners.

Information in this document supersedes and replaces information previously supplied in any prior versions of this document.

© 2019 STMicroelectronics – All rights reserved