

LED Lamp Module

A60 F0 type module



- **Maximum up to 7W**
- **CREE LEDs**
- **E26 and E27 lamp base**
- **UL plastic material**

The lamp base can be compatible to either E26 or E27 standard base.

The Heat dissipation of A60 F0 type module heat sink can be up to maximum 7 wattage.

A60 F0 type module uses UL listed material for all the plastic components.

A60 F0 type module will be the best solution for bulb lamp.

▶▶ Table of Contents

Specifications	P. 3
Exterior Dimensions	P. 4
Nomenclature	P. 4
Part Number	P. 5
The circuit design reference	P. 6
Life Time	P. 6
Package information	P. 7 ~ P. 10
Reference information	P. 11 ~ P. 20

Specifications

Module Name	A60 F0 type module	
With the use of LED	 CXA1512	
Rating Power	Maximum up to 7 Wattage	
LED Quantity	1pcs	
LED Dispose Mode	1S	
Lens efficiency	80%	
Lamp holder	E26 type	E27 type
Exterior Dimension	60*112 mm	60*115mm
Beam Angle	270 deg.	
Operate Temperature	-20°C~+50°C	
Storage Temperature	-20°C~+50°C	

Table 1 : The specifications for A60 F0 type.

▶▶ Exterior Dimension

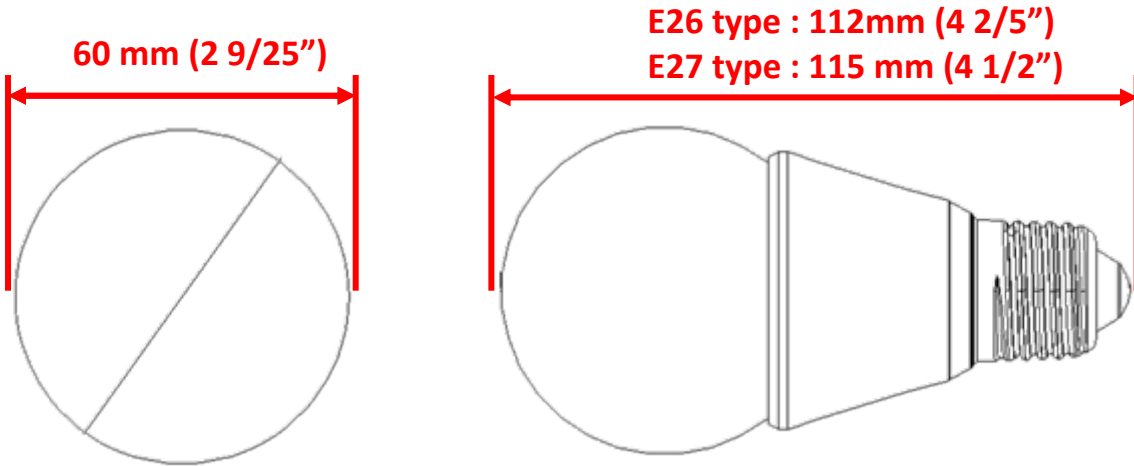

Tolerance : 2.5 mm (1/10")

Figure 1 : The exterior dimension for A60 F0 type module.

▶▶ Nomenclature

M A60F0 B E27 – L B7 01 – BAG 00

X1 X2 X3 X4 X5 X6 X7 X8 X9

X1

Company Code

M : Ledlink Module

X2

Product Series Type

A60F0 : A60F0 type

X3

Exterior Color

W : White
B : Black

X4

Lamp Holder

E26 : E26 type
E27 : E27 type

X5

Lens type

L : Lampshade

X6

Beam Angle

B7 : 270 degrees

X7

Lens Quantity

01: Single

X8

Lens Number

BAG: BAG model

X9

Package

00 : series number

Figure 2 : The nomenclature for A60 F0 type module.

▶▶ Part Number

Part Number	Lamp Holder	Heat sink Material	Plastic Material	Plastic Color	Cover color
MA60F0BE26-LB701-BAG00	E26 type	ADC 12 + Anodized	UL approval Plastic*	Black	
MA60F0WE26-LB701-BAG00				White	
MA60F0BE27-LB701-BAG00	E27 type			Black	
MA60F0WE27-LB701-BAG00				White	

* : Please refer to "reference information" in page 11 ~ 15.

Table 2 : The part number for A60 F0 type.

▶▶ The circuit design reference

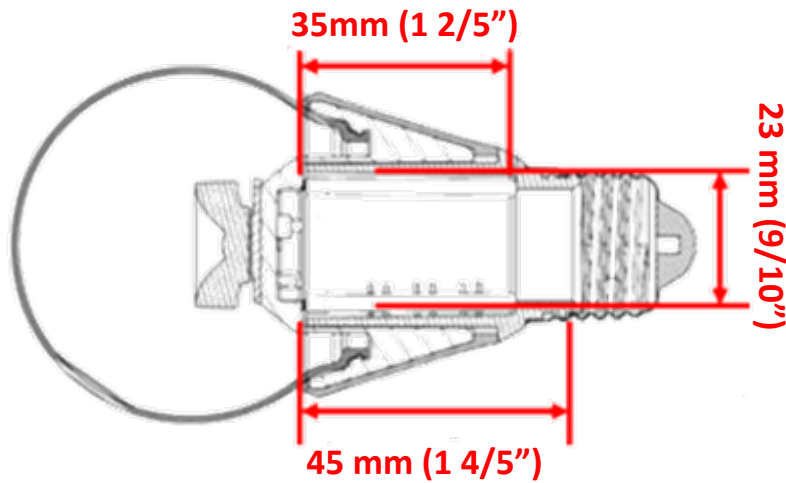

Figure 3 : The maximum size of the circuit area for A60 F0 type module.

Notification : A60 F0 type module doesn't include the circuit part

▶▶ Life Time

Lighting Output

Ambient temperature

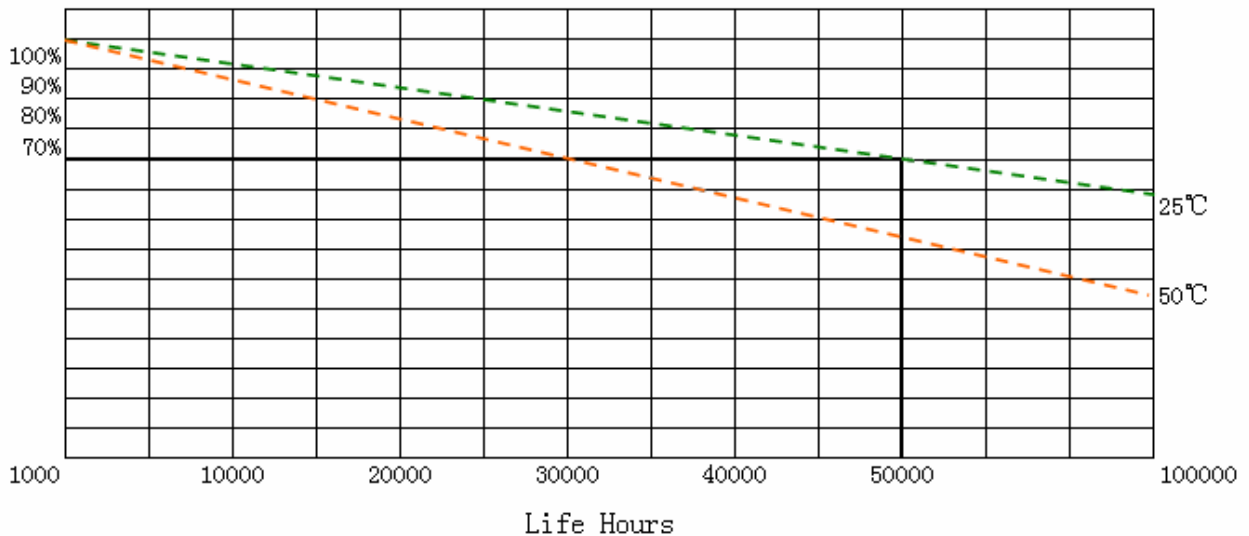

Figure 4: Lighting Output & Life Hours

Package information

Lamp shade part :



← Lamp shade

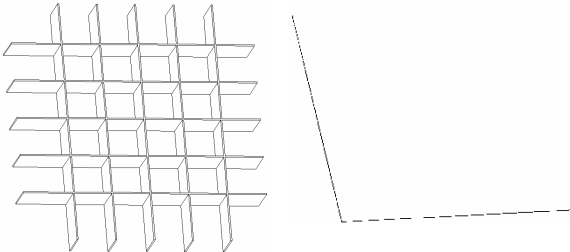

← Put Mode:
1PCS*36=36pcs



← Inner Box:
36PCS*6=216pcs

Figure 5: The package information for Lamp shade part.

Package information

Lens part :

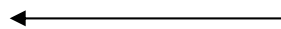

Lens

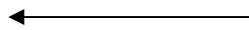
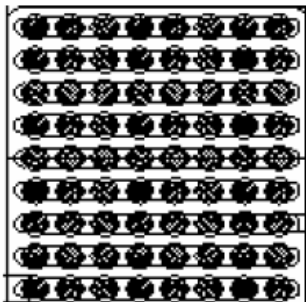

Put Mode:
 $8\text{PCS} \times 9 = 72\text{pcs}$

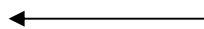
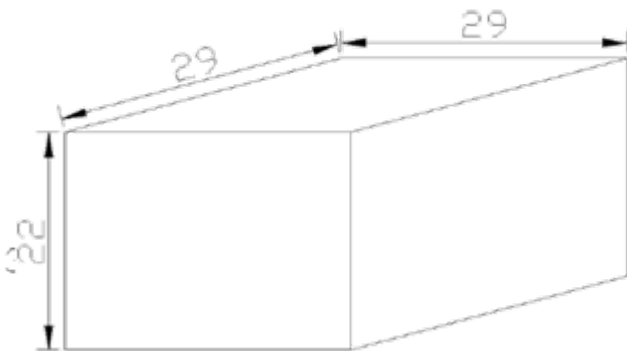

Inner Box:
 $72\text{PCS} \times 12 = 864\text{pcs}$

Figure 5: The package information for Lens part.

Package information

Heat sink part :

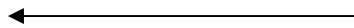

Heat sink

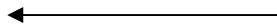
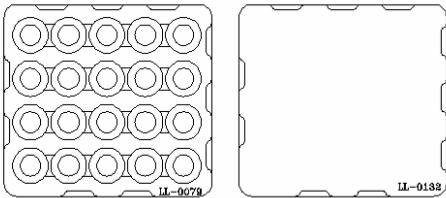

Put Mode:
20pcs

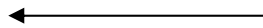
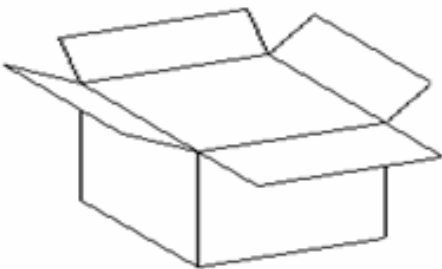

Inner Box:
 $20 \times 3 = 60$ pcs

Figure 6 : The package information for heat sink part.

Package information

Lamp base part :



← Lamp Base

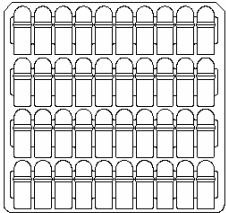

← Put Mode:
1*40=40pcs

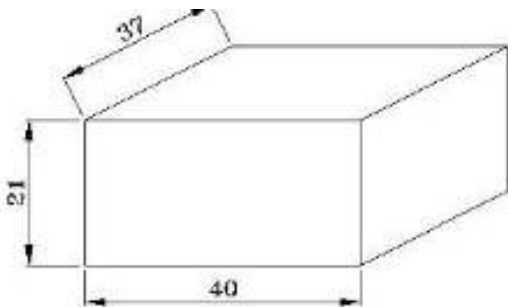

← Inner Box:
40*6 Tier=240pcs

Figure 7 : The package information for lamp base part..

▶▶ Reference information

The UL card of UL plastic material :

Component - Plastics							E135714
NYTEX COMPOSITES CO LTD							
6 LANE 468 CHANGSUI RD, SEC 4, PEITOU HSIANG CHANGHUA HSIEN 523 TW							
CM-5000							
Polyamide 66/6 (PA66/6), blend, mineral fiber, flame retardant, furnished as pellets							
	Min Thk	Flame			RTI	RTI	RTI
Color	(mm)	Class	HWI	HAI	Elec	Imp	Str
BK	1.6	V-0	2	1	65	65	65
	3.2	V-0	1	1	65	65	65
Comparative Tracking Index (CTI): -				Inclined Plane Tracking (IPT): -			
Dielectric Strength (kV/mm): -				Volume Resistivity (10 ⁹ ohm-cm): -			
High-Voltage Arc Tracking Rate (HVTR): -				High Volt, Low Current Arc Resis (D495): -			
Dimensional Stability (%): -							
ANSI/UL 94 small-scale test data does not pertain to building materials, furnishings and related contents. ANSI/UL 94 small-scale test data is intended solely for determining the flammability of plastic materials used in the components and parts of end-product devices and appliances, where the acceptability of the combination is determined by UL.							
Report Date: 2013-03-19							
Last Revised: 2013-03-19							
© 2013 UL LLC							
							
IEC and ISO Test Methods							
Test Name	Test Method	Units	Thickness	Tested (mm)	Value		
Flammability	IEC 60695-11-10	Class (color)	1.6		V-0 (BK)		
			3.2		V-0 (BK)		
Glow-Wire Flammability (GWFI)	IEC 60695-2-12	C	-		-		
Glow-Wire Ignition (GWIT)	IEC 60695-2-13	C	-		-		
IEC Comparative Tracking Index	IEC 60112	Volts (Max)	-		-		
IEC Ball Pressure	IEC 60695-10-2	C	-		-		
ISO Heat Deflection (1.80 MPa)	ISO 75-2	C	-		-		
ISO Tensile Strength	ISO 527-2	MPa	-		-		
ISO Flexural Strength	ISO 178	MPa	-		-		
ISO Tensile Impact	ISO 8256	kJ/m ²	-		-		
ISO Izod Impact	ISO 180	kJ/m ²	-		-		
ISO Charpy Impact	ISO 179-2	kJ/m ²	-		-		
© 2013 UL LLC							

Figure8 : The UL card information of the sink part.

Reference information

The UL card of UL plastic material :

Component - Plastics							E206114
STYRON (HONG KONG) LTD							
TSING YI R & D LABORATORY, 40-50 TSING YI RD, TSING YI ISLAND N T HK							
EMERGE PC 8130-(i)(f1)							
Polycarbonate (PC), "EMERGE", furnished as pellets							
Color	Min Thk (mm)	Flame Class	HWI	HAI	RTI Elec	RTI Imp	RTI Str
ALL	1.5	V-0	2	1	130	115	130
	3.0	V-0,5VA	2	1	130	115	130
Comparative Tracking Index (CTI): 2				Inclined Plane Tracking (IPT): -			
Dielectric Strength (kV/mm): -				Volume Resistivity (10 ^x ohm-cm) : -			
High-Voltage Arc Tracking Rate (HVTR): 1				High Volt, Low Current Arc Resis (D495): 7			
Dimensional Stability (%): -							
(f1) - Suitable for outdoor use with respect to exposure to Ultraviolet Light, Water Exposure and Immersion in accordance with UL 746C.							
(i) - Followed by suffix numbers 3-15 incl. indicating melt flow rate							
ANSI/UL 94 small-scale test data does not pertain to building materials, furnishings and related contents. ANSI/UL 94 small-scale test data is intended solely for determining the flammability of plastic materials used in the components and parts of end-product devices and appliances, where the acceptability of the combination is determined by UL.							
Report Date: 2011-07-12							
Last Revised: 2013-08-30							
© 2014 UL LLC							
							
IEC and ISO Test Methods							
Test Name	Test Method	Units	Thickness Tested (mm)	Value			
Flammability	IEC 60695-11-10, IEC 60695-11-20	Class (color)	1.5	V-0 (ALL)			
			3.0	V-0,5VA (ALL)			
Glow-Wire Flammability (GWF1)	IEC 60695-2-12	C	-	-			
Glow-Wire Ignition (GWIT)	IEC 60695-2-13	C	-	-			
IEC Comparative Tracking Index	IEC 60112	Volts (Max)	-	-			
IEC Ball Pressure	IEC 60695-10-2	C	3.0	137			
ISO Heat Deflection (1.80 MPa)	ISO 75-2	C	-	-			
ISO Tensile Strength	ISO 527-2	MPa	-	-			
ISO Flexural Strength	ISO 178	MPa	-	-			
ISO Tensile Impact	ISO 8256	kJ/m ²	-	-			
ISO Izod Impact	ISO 180	kJ/m ²	-	-			
ISO Charpy Impact	ISO 179-2	kJ/m ²	-	-			
© 2014 UL LLC							

Figure 9 : The UL card information of the Lamp shade part.

Reference information

The UL card of UL plastic material :

Component - Plastics							E48268
IDEMITSU KOSAN CO LTD BASIC CHEMICALS DEPT, 1-1 ANESAKI-KAIGAN, ICHIHARA-SHI CHIBA-KEN 299-0193 JP							
LEV1700							
Polycarbonate (PC), furnished as pellets							
Color	Min Thk (mm)	Flame Class	HWI	HAI	RTI Elec	RTI Imp	RTI Str
NC	0.42-1.9	V-2	-	-	80	80	80
Comparative Tracking Index (CTI): -				Dimensional Stability (%): -			
High-Voltage Arc Tracking Rate (HVTR): -				High Volt, Low Current Arc Resis (D495): -			
Dielectric Strength (kV/mm): -				Volume Resistivity (10 ⁸ ohm-cm) : -			
<small>ANSI/UL 94 small-scale test data does not pertain to building materials, furnishings and related contents. ANSI/UL 94 small-scale test data is intended solely for determining the flammability of plastic materials used in the components and parts of end-product devices and appliances, where the acceptability of the combination is determined by UL.</small>							
Report Date: 2010-04-06		Underwriters Laboratories Inc®					
Last Revised: 2010-04-06							
IEC and ISO Test Methods							
Test Name	Test Method	Units	Thickness Tested (mm)	Value			
Flammability	IEC 60695-11-10	Class (color)	0.42-1.9	V-2 (NC)			
Glow-Wire Flammability (GWFI)	IEC 60695-2-12	C	-	-			
Glow-Wire Ignition (GWIT)	IEC 60695-2-13	C	-	-			
IEC Comparative Tracking Index	IEC 60112	Volts (Max)	-	-			
IEC Ball Pressure	IEC 60695-10-2	C	-	-			
ISO Heat Deflection (1.80 MPa)	ISO 75-2	C	-	-			
ISO Tensile Strength	ISO 527-2	MPa	-	-			
ISO Flexural Strength	ISO 178	MPa	-	-			
ISO Tensile Impact	ISO 8256	kJ/m ²	-	-			
ISO Izod Impact	ISO 180	kJ/m ²	-	-			
ISO Charpy Impact	ISO 179-2	kJ/m ²	-	-			
Underwriters Laboratories Inc®							

Figure 10 : The UL card information of the lens part.

▶▶ Reference information

The UL card of UL plastic material :

Component - Plastics					E48268		
IDEMITSU KOSAN CO LTD							
1-1 MARUNOUCHI 3-CHOME, CHIYODA-KU, TOKYO 100-0005 JP							
URC2500							
Polycarbonate (PC), furnished as pellets							
	Min Thk	Flame			RTI	RTI	RTI
Color	(mm)	Class	HWI	HAI	Elec	Imp	Str
WT	1.5	V-0	-	-	80	80	80
	3.0	V-0	-	-	80	80	80
Comparative Tracking Index (CTI): -					Dimensional Stability (%): -		
High-Voltage Arc Tracking Rate (HVTR): -					High Volt, Low Current Arc Resis (D495): -		
Dielectric Strength (kV/mm): -					Volume Resistivity (10 ^X ohm-cm) : -		
<small>UL94 small-scale test data does not pertain to building materials, furnishings and related contents. UL94 small-scale test data is intended solely for determining the flammability of plastic materials used in the components and parts of end-product devices and appliances, where the acceptability of the combination is determined by ULI.</small>							
Report Date: 2006-09-18		Underwriters Laboratories Inc®					
Last Revised: 2006-09-18							
IEC and ISO Test Methods							
Test Name	Test Method	Units	Thickness Tested (mm)	Value			
IEC Flammability	IEC 60695-11-10	Class (color)	1.5	V-0 (WT)			
			3.0	V-0 (WT)			
Glow-Wire Flammability (GWFI)	IEC 60695-2-12	C	-	-			
Glow-Wire Ignition (GWIT)	IEC 60695-2-13	C	-	-			
IEC Comparative Tracking Index	IEC 60112	Volts (Max)	-	-			
IEC Ball Pressure	IEC 60695-10-2	C	-	-			
ISO Heat Deflection (1.80 MPa)	ISO 75-2	C	-	-			
ISO Tensile Strength	ISO 527-2	MPa	-	-			
ISO Flexural Strength	ISO 178	MPa	-	-			
ISO Tensile Impact	ISO 8256	kJ/m ²	-	-			
ISO Izod Impact	ISO 180	kJ/m ²	-	-			
ISO Charpy Impact	ISO 179-2	kJ/m ²	-	-			
Underwriters Laboratories Inc®							

Figure 11 : The UL card information of the lamp base part.(White)

Reference information

The UL card of UL plastic material :

Component - Plastics								E-18268
IDEMITSU KOSAN CO LTD								
1-1 MARUNOUCHI 3-CHOME, CHIYODA-KU, TOKYO 100-0005 JP								
LE1700								
Polycarbonate (PC), furnished as pellets								
Color	Min Thk (mm)	Flame Class	HWI	HAI	RTI Elec	RTI Imp	RTI Str	
NC	0.45-0.50	V-2	-	-	80	80	80	
	1.5	-	3	3	80	80	80	
Comparative Tracking Index (CTI): -				Inclined Plane Tracking (IPT): -				
Dielectric Strength (kV/mm): -				Volume Resistivity (10 ^x ohm-cm): -				
High-Voltage Arc Tracking Rate (HVTR): -				High Volt, Low Current Arc Resis (D495): -				
Dimensional Stability (%): -								
ANSI/UL 94 small-scale test data does not pertain to building materials, furnishings and related contents. ANSI/UL 94 small-scale test data is intended solely for determining the flammability of plastic materials used in the components and parts of end-product devices and appliances, where the acceptability of the combination is determined by UL.								
Report Date: 2000-03-31		© 2012 UL LLC				UL		
Last Revised: 2009-03-30								
IEC and ISO Test Methods								
Test Name	Test Method	Units	Thickness Tested (mm)	Value				
Flammability	IEC 60695-11-10	Class (color)	0.45-0.50	V-2 (IIC)				
			1.5	- (IIC)				
Glow-Wire Flammability (GWFI)	IEC 60695-2-12	C	-	-				
Glow-Wire Ignition (GWIT)	IEC 60695-2-13	C	-	-				
IEC Comparative Tracking Index	IEC 60112	Volts (Max)	-	-				
IEC Ball Pressure	IEC 60695-10-2	C	-	-				
ISO Heat Deflection (1.80 MPa)	ISO 75-2	C	-	-				
ISO Tensile Strength	ISO 527-2	MPa	-	-				
ISO Flexural Strength	ISO 178	MPa	-	-				
ISO Tensile Impact	ISO 8256	kJ/m ²	-	-				
ISO Izod Impact	ISO 180	kJ/m ²	-	-				
ISO Charpy Impact	ISO 179-2	kJ/m ²	-	-				
© 2012 UL LLC								

Figure 12 : The UL card information of the lamp base part.(Black)

▶▶ Reference information

The SGS card of SGS plastic material :



Test Report No. CANEC1319750803 Date: 26 Dec 2013 Page 1 of 5

DONGGUANCITY DAHONG PIASTIC PRODUCTS FACTORY
INDUSTRIAL DISTRICT,SHANGTONG VILLAGE QISHITOWN

The following sample(s) was/were submitted and identified on behalf of the clients as : POWDER BLACK

SGS Job No. : CP13-065023 - GZ

Client Ref. Info. : K401, K402, K402A, K403, K404, K417, K418, B2014, B2014A, B2014C, B2014E, B2014P, B2015, B8008, B8008-A, B8007, B8011, B8011A, B8012, B8015, B859, C90584 Mixture

Date of Sample Received : 17 Dec 2013

Testing Period : 17 Dec 2013 - 23 Dec 2013

Test Requested : Selected test(s) as requested by client.

Test Method : Please refer to next page(s).

Test Results : Please refer to next page(s).

Conclusion : Based on the performed tests on submitted samples, the results of Lead, Mercury, Cadmium, Hexavalent chromium, Polybrominated biphenyls (PBB), Polybrominated diphenyl ethers (PBDE) comply with the limits as set by RoHS Directive 2011/65/EU Annex II; recasting 2002/95/EC.

Signed for and on behalf of
SGS-CSTC Ltd.

Merry

Merry Lv
Approved Signatory

This document is issued by the Company subject to its General Conditions of Service printed overleaf, available on request or accessible at <http://www.sgs.com/en/Terms-and-Conditions.aspx> and, for electronic format documents, subject to Terms and Conditions for Electronic Documents at <http://www.sgs.com/en/Terms-and-Conditions/Terms-and-Conditions.aspx>. The Company's findings at the time of its intervention only and within the limits of Client's instructions, if any. The Company's sole responsibility is to its Client and this document does not exonerate parties to a transaction from exercising all their rights and obligations under the transaction documents. This document cannot be reproduced except in full, without prior written approval of the Company. Any unauthorized alteration, forgery or falsification of the content or appearance of this document is unlawful and offenders may be prosecuted to the fullest extent of the law. Unless otherwise stated the results shown in this test report refer only to the sample(s) tested.



 SGS (China) Technical Service, Ltd.
 中国·广州·经济技术开发区科学城科城路199号 邮编: 510663 电话: 86-20-82135555 传真: 86-20-82075113 www.sgs.com.cn
 SGS (China) Technical Service, Ltd.
 中国·广州·经济技术开发区科学城科城路199号 邮编: 510663 电话: 86-20-82135555 传真: 86-20-82075113 +sgschina@sgs.com

Figure 13 : The SGS card information of the lamp base part.(Black)

▶▶ Reference information

The SGS card of SGS plastic material :



Test Report No. CANEC1319750803 Date: 26 Dec 2013 Page 2 of 5

Test Results :

Test Part Description :

Specimen No.	SGS Sample ID	Description
SN1	CAN13-197508.003	Black powder

Remarks :

- (1) 1 mg/kg = 1 ppm = 0.0001%
- (2) MDL = Method Detection Limit
- (3) ND = Not Detected (< MDL)
- (4) "-" = Not Regulated

RoHS Directive 2011/65/EU

Test Method : (1)With reference to IEC 62321-5:2013, determination of Cadmium by ICP-OES.
 (2)With reference to IEC 62321-5:2013, determination of Lead by ICP-OES.
 (3)With reference to IEC 62321-4:2013, determination of Mercury by ICP-OES.
 (4)With reference to IEC 62321:2008, determination of Hexavalent Chromium by Colorimetric Method using UV-Vis.
 (5)With reference to IEC 62321:2008, determination of PBBs and PBDEs by GC-MS.

Test Item(s)	Limit	Unit	MDL	/03
Cadmium (Cd)	100	mg/kg	2	ND
Lead (Pb)	1,000	mg/kg	2	ND
Mercury (Hg)	1,000	mg/kg	2	ND
Hexavalent Chromium (CrVI)	1,000	mg/kg	2	ND
Sum of PBBs	1,000	mg/kg	-	ND
Monobromobiphenyl	-	mg/kg	5	ND
Dibromobiphenyl	-	mg/kg	5	ND
Tribromobiphenyl	-	mg/kg	5	ND
Tetrabromobiphenyl	-	mg/kg	5	ND
Pentabromobiphenyl	-	mg/kg	5	ND
Hexabromobiphenyl	-	mg/kg	5	ND
Heptabromobiphenyl	-	mg/kg	5	ND
Octabromobiphenyl	-	mg/kg	5	ND
Nonabromobiphenyl	-	mg/kg	5	ND
Decabromobiphenyl	-	mg/kg	5	ND
Sum of PBDEs	1,000	mg/kg	-	ND
Monobromodiphenyl ether	-	mg/kg	5	ND

This document is issued by the Company subject to its General Conditions of Service printed overleaf, available on request or accessible at <http://www.sgs.com/en/Terms-etc-Conditions.aspx> and for electronic format documents, subject to Terms and Conditions for Electronic Documents at <http://www.sgs.com/en/Terms-and-Conditions/Terms-etc-Document.aspx>. Attention is drawn to the limitation of liability, indemnification and jurisdiction issues defined therein. Any holder of this document is advised that information contained herein reflects the Company's findings at the time of its intervention only and within the limits of Client's instructions, if any. The Company's sole responsibility is to its Client and this document does not exonerate parties to a transaction from exercising all their rights and obligations under the transaction documents. This document cannot be reproduced except in full without prior written approval of the Company. Any unauthorized alteration, forgery or falsification of the content or appearance of this document is unlawful and offenders may be prosecuted to the fullest extent of the law. Unless otherwise stated the results shown in this test report refer only to the sample(s) tested.



SGS-CTI Technical Services, Ltd.
 Singapore Economic Development Corporation

中国·广州·经济技术开发区科学城科韵路196号 邮编: 510663 1 (86-20) 82155555 1 (86-20) 82075113 www.sgs.com.cn

1 (86-20) 82155555 1 (86-20) 82075113 # sgschina@sgs.com

Member of the RFLS Group (RFLS S&S)

Figure 14 : The SGS card information of the lamp base part.(Black)

Reference information

The SGS card of SGS plastic material :



Test Report
No. CANEC1319750803
Date: 26 Dec 2013
Page 3 of 5

Test Item(s)	Limit	Unit	MDL	003
Dibromodiphenyl ether	-	mg/kg	5	ND
Tribromodiphenyl ether	-	mg/kg	5	ND
Tetrabromodiphenyl ether	-	mg/kg	5	ND
Pentabromodiphenyl ether	-	mg/kg	5	ND
Hexabromodiphenyl ether	-	mg/kg	5	ND
Heptabromodiphenyl ether	-	mg/kg	5	ND
Octabromodiphenyl ether	-	mg/kg	5	ND
Nonabromodiphenyl ether	-	mg/kg	5	ND
Decabromodiphenyl ether	-	mg/kg	5	ND

Notes :

(1) The maximum permissible limit is quoted from the directive 2011/65/EU, Annex II

This document is issued by the Company subject to its General Conditions of Service printed overleaf, available on request or accessible at <http://www.sgs.com/en/Terms-and-Conditions.aspx> and for electronic format documents, subject to Terms and Conditions for Electronic Documents at <http://www.sgs.com/en/Terms-and-Conditions/Terms-and-Conditions.aspx>. No responsibility is drawn to the limitation of liability, indemnification and jurisdiction issues defined therein. Any holder of this document is advised that information contained herein reflects the Company's findings at the time of its intervention only and within the limits of Client's instructions, if any. The Company's sole responsibility is to its Client and this document does not exonerate parties to a transaction from exercising all their rights and obligations under the transaction documents. This document cannot be reproduced except in full, without prior written approval of the Company. Any unauthorized alteration, forgery or falsification of the content or appearance of this document is unlawful and offenders may be prosecuted to the fullest extent of the law. Unless otherwise stated the results shown in this test report refer only to the sample(s) tested.



SGS-Service Technical Services, Ltd.
 Guangzhou, China
 18 Kaili Road, Guangzhou Economic & Technological Development Zone, Guangzhou, China 510663 | (86-20) 82155555 | (86-20) 82175113 | www.sgs.com.cn
 中国·广州·经济技术开发区科学城科珠路190号 邮编: 510663 | (86-20) 82155555 | (86-20) 82175113 | sgschina@sgs.com

Member of the SGS Group (SGS SA)

Figure 15 : The SGS card information of the lamp base part.(Black)

▶▶ Reference information

The SGS card of SGS plastic material :

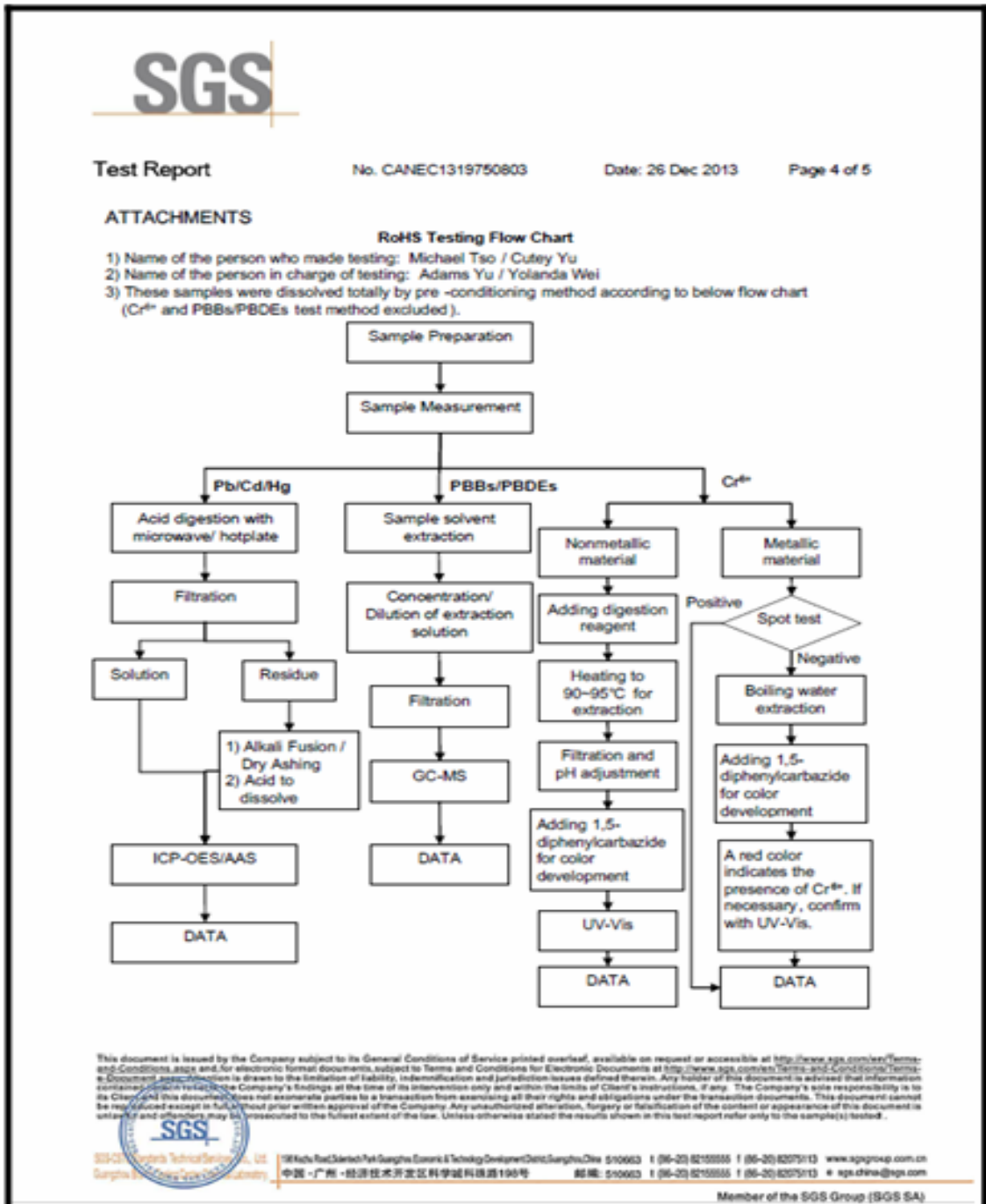

Figure 16 : The SGS card information of the lamp base part.(Black)

▶▶ Reference information

The SGS card of SGS plastic material :



Figure 17: The SGS card information of the lamp base part.(Black)