

SX1211-11SKA

User's Guide: Advanced Mode

Table of Contents

1	Introduction	4
2	Getting Started	5
2.1	<i>Kit Contents.....</i>	5
2.2	<i>Installation.....</i>	5
2.3	<i>SX1211SKA Overview</i>	6
3	Quick Start Guide.....	7
3.1	<i>SX1211SKA Quick Start (All Modes).....</i>	7
3.2	<i>SX1211SKA Receive Mode Configuration.....</i>	9
3.3	<i>SX1211SKA Transmit Mode Configuration.....</i>	10
4	SX1211SXA Software Description.....	11
4.1	<i>Overview</i>	11
4.2	<i>File Menu.....</i>	11
4.3	<i>Shortcut Buttons.....</i>	12
4.4	<i>Text Field Conventions for the SX1211SKA.....</i>	13
4.5	<i>McParam Tab.....</i>	13
4.6	<i>Overview Panel.....</i>	15
4.7	<i>Register Hexadecimal Display</i>	15
4.8	<i>The Mode Control Box</i>	16
4.9	<i>The IrqParam Tab.....</i>	17
4.10	<i>The RxParam Tab.....</i>	17
4.11	<i>The TxParam Tab</i>	19
4.12	<i>The OscParam Tab.....</i>	20
4.13	<i>The Packet Test Tab.....</i>	20
5	Schematics and 2-Layer PCB Layout: SX1211SKA.....	23
6	References	25

Table of Figures

Figure 1. SX1211 Application Circuit	4
Figure 2. SX1211SKA Contents.....	5
Figure 3. SX1211SKA Board Picture	6
Figure 4. SX1211 User Interface, Default Settings.....	7
Figure 5. The New SX1211 Configuration: Ready to be Written	8
Figure 6. The SX1211SKA User Interface whilst in Packet Receiver Mode.....	9
Figure 7. The SX1211SKA User Interface Ready to Transmit the Demonstration Packet.....	10
Figure 8. SX1211SKA GUI Overview and References to the User Guide Description of this Chapter.....	11
Figure 9. Example Text Editor Output of the SX1211 Configuration File	12
Figure 10. SX1211 Local Oscillator Generation.....	15
Figure 11. The Overview Panel.....	15
Figure 12. The Hexadecimal Register Display Summary	16
Figure 13. The Mode Control Box also Incorporates RSSI.....	16
Figure 14. The Interrupt Mapping Display.....	17
Figure 15. SX1211 Receiver Block Diagram, the Colours Correspond to the Frequency of Operation.....	17
Figure 16. Receiver Parameter Display	18
Figure 17. SX1211 Simplified Transmitter Block Schematic Diagram.....	19
Figure 18. The Transmitter Parameter Tab Display.....	19
Figure 19. The Oscillator Parameter Display	20
Figure 20. The Packet Receiver / Transmitter Test Display	21
Figure 21. Software Display: Successful Packet Mode Reception.....	22

1 Introduction

The SX1211 is a single chip transceiver IC designed for operation in the European 868 MHz and U.S. 915 MHz licence free ISM bands. The SX1211 is optimized for very low power consumption (3mA in receiver mode). It incorporates a baseband modem with data rates up to 200 kb/s. Data handling features include a sixty-four byte FIFO, packet handling, automatic CRC generation and data whitening. Its highly integrated architecture allows for minimum external component count whilst maintaining design flexibility. All major RF communication parameters are programmable and most of them may be dynamically set.

The SX1211SKA is a USB evaluation tool designed to allow simple and easy evaluation of the suitability of the SX1211 for a given application. The low component count reference design implemented in the SX1211SKA is shown below:

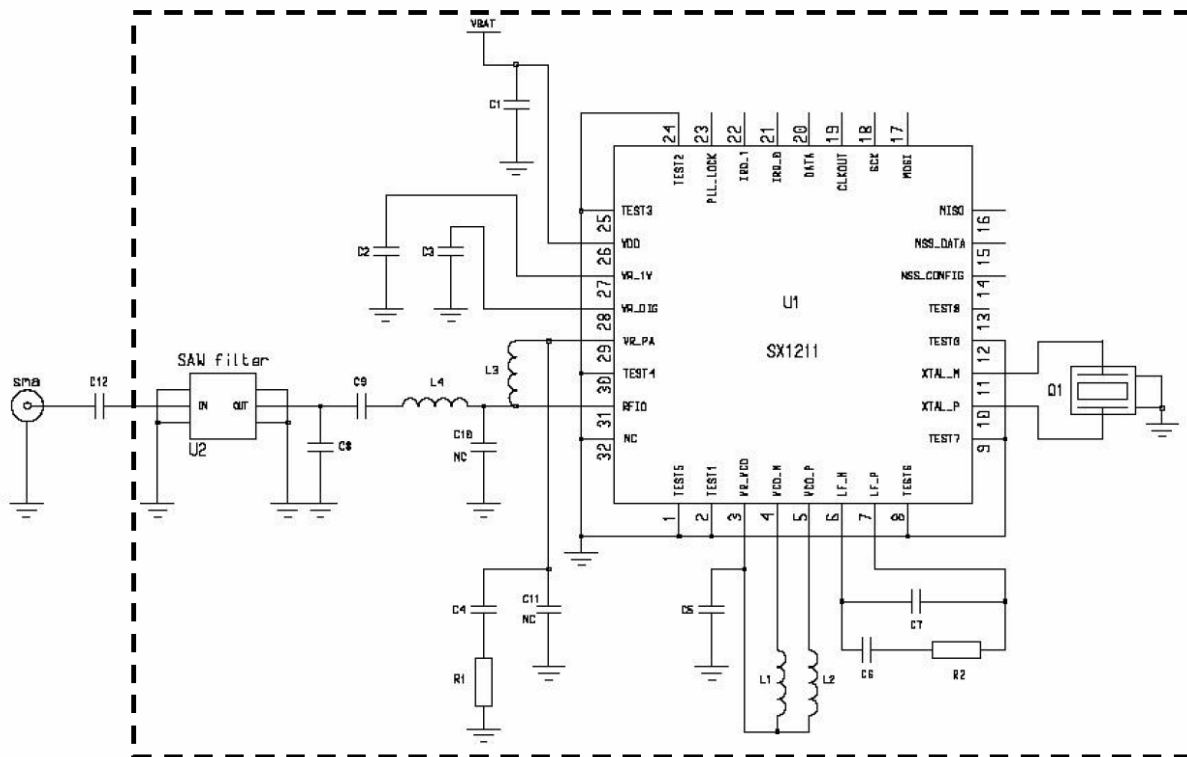

Figure 1. SX1211 Application Circuit

The SX1211 main features include:

- Low Rx power consumption: 3mA
- Low Tx power consumption: 25 mA @ +10 dBm
- Good reception sensitivity: down to -107 dBm at 25 kb/s in FSK, -113 dBm at 2kb/s in OOK
- Programmable RF output power: up to +12.5 dBm in 8 steps
- Packet handling feature with data whitening and automatic CRC generation
- Wide RSSI (Received Signal Strength Indicator) dynamic range, 70dB from Rx noise floor
- Bit rates up to 200 kb/s, NRZ coding
- On-chip frequency synthesizer
- FSK and OOK modulation
- Incoming sync word recognition
- Built-in Bit-Synchronizer for incoming data and clock synchronization and recovery

2 Getting Started

2.1 Kit Contents

As illustrated in the figure below, the SX1230-11SKA Evaluation kit is composed of:

- A pair of SX1211SKA boards
- SX1211-11SKA CDROM including all necessary PC software and documentation



Figure 2. SX1211SKA Contents

2.2 Installation

SX1211SKA Advanced Mode Software Installation

- 1- Put the CDROM in your computer and browse the contents of the CD.
- 2- Open the "sx1211starterkitsetupweb.exe" manually. It can be found in the \Installers sub directory of the CD-ROM.
- 3- Follow installation guidelines until the process is completed. Please note that .NET Framework 2.0 and the FTDI USB driver will be automatically installed if not detected on your computer.
- 4- Connect the SX1211SKA board to the PC via the USB interface.
- 5- Launch "SX1211SKA" from the Start menu.
- 6- Click on "Connect" button in toolbar or in File menu.
- 7- SX1211SKA is now installed and ready to be used.

2.3 SX1211SKA Overview

The SX1211SKA features the SX1211 reference design (1) and is also interfaced via an FTDI bridge (6) to the USB type 'A' interface (5) of a host PC. Indication of transmission and reception is indicated on a pair of LEDs (4). A Johanson Technologies ceramic antenna is employed (2) and optional provision for an SMA connector (not populated) is provided for laboratory testing.

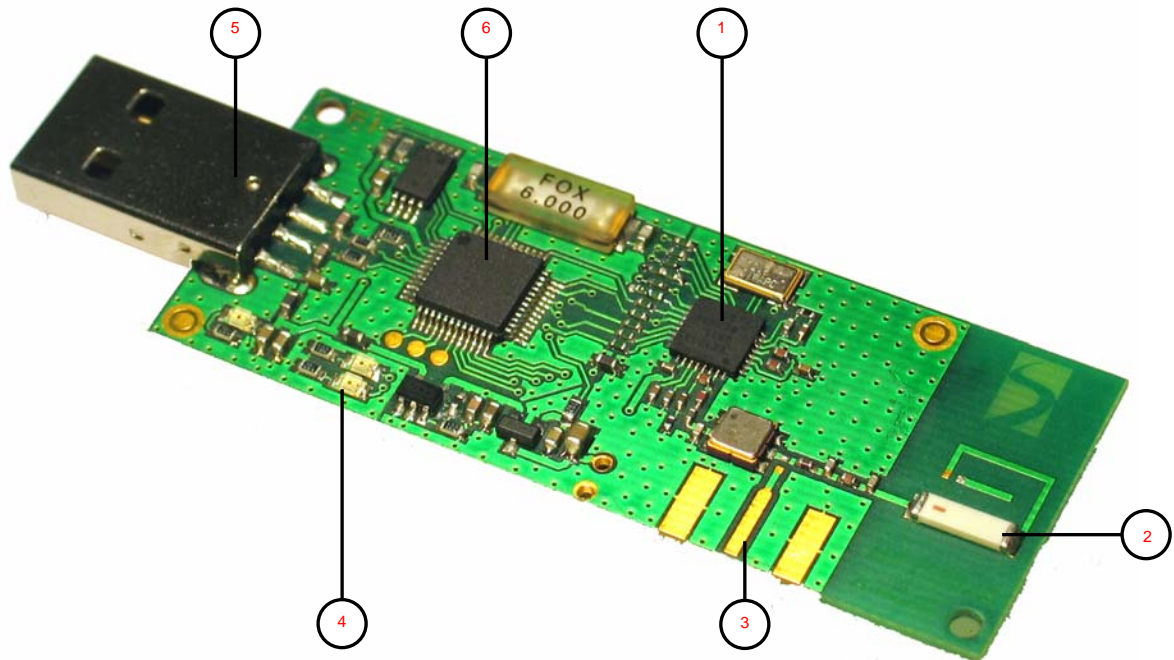

Figure 3. SX1211SKA Board Picture

3 Quick Start Guide

With the SX1211SKA software installed, follow the sequence below to establish communication between the one SX1211SKA as transmitter and one SX1211SKA as receiver.

3.1 SX1211SKA Quick Start (All Modes)

1. Plug the SX1211SKA into the USB port of the computer.
2. Run the SX1211 User Interface software Start > All Programs > SX1211SKA > SX1211SKA

3. The SX1211SKA should connect automatically to the User Interface Software. If not, then click on the USB connect short-cut button, located in the top left hand corner of the window.



4. Once connected the SX1211SKA shows the default configuration of the SX1211 register settings upon power-up.

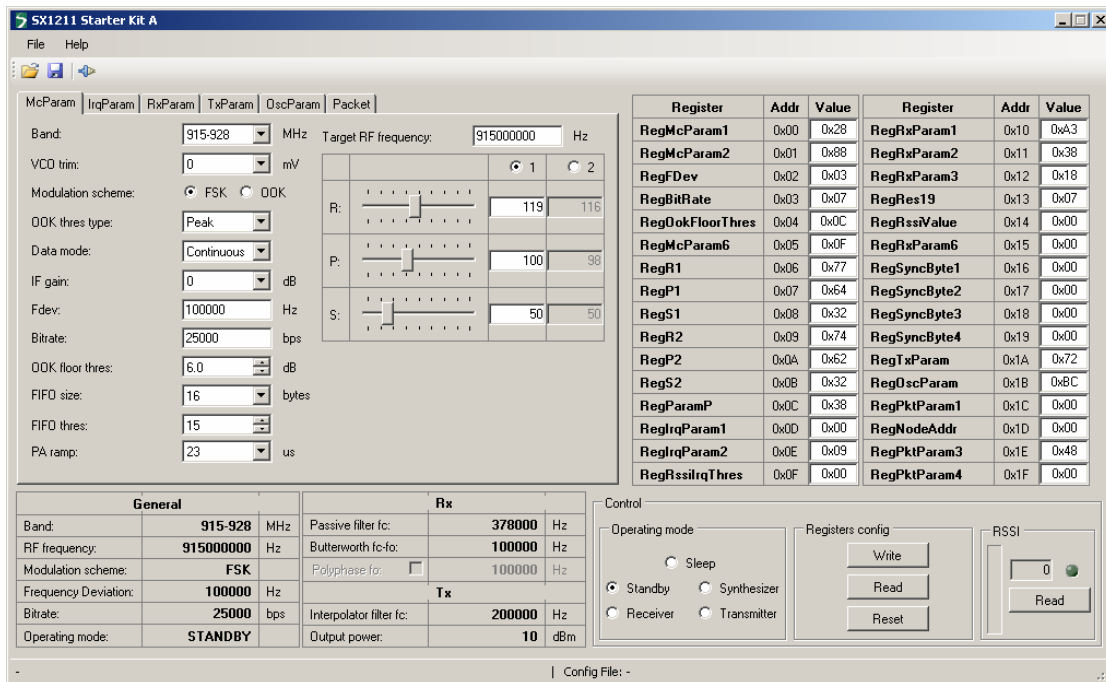

Figure 4. SX1211 User Interface, Default Settings

5. Once connected the SX1211SKA shows the default configuration of the SX1211 register settings upon power-up (as shown in Figure 4).

- The settings for communication between transceiver kits are located on the installation CD-ROM provided with the kit. Use the File > Open from the menu bar, or the open short-cut button to load a configuration file.



- Load the "XXX_SX1211_pingpong.cfg" file from the "SX1211 Demo Files" folder on the CD-ROM. Where XXX corresponds to the frequency band of the SX1211SKA (either 868 or 915 MHz).

- The display will then appear as shown in Figure 5.

The screenshot shows the SX1211 Starter Kit A software interface. It features a menu bar (File, Help), a toolbar, and several tabs (McParam, IrqParam, RxParam, TxParam, OscParam, Packet). The main area is divided into several sections:

- Configuration Parameters:** Includes fields for Band (902-915 MHz), VCO trim (0 mV), Modulation scheme (FSK selected), OOK thres type (Peak), Data mode (Packet), IF gain (0 dB), Fdev (50000 Hz), Bitrate (25000 bps), OOK floor thres (6.0 dB), FIFO size (64 bytes), FIFO thres (15), and PA ramp (23 us).
- Target RF frequency:** Set to 908000000 Hz.
- Waveform Diagrams:** Shows R, P, and S waveforms with associated values (e.g., R: 125, 116; P: 104, 98; S: 70, 50).
- Register Summary Table:** A table listing registers, their addresses, and values. Red text indicates values that have not yet been written to the hardware.
- General and Rx/Tx Parameters Table:** A summary table of key parameters.
- Control Section:** Includes operating mode (Receiver selected), registers config (Write, Read, Reset buttons), and RSSI (34 dBm).

Register	Addr	Value	Register	Addr	Value
RegMcParam1	0x00	0x60	RegRxParam1	0x10	0xA3
RegMcParam2	0x01	0x8C	RegRxParam2	0x11	0x38
RegFDev	0x02	0x07	RegRxParam3	0x12	0x18
RegBitRate	0x03	0x07	RegRes19	0x13	0x07
RegOokFloorThres	0x04	0x0C	RegRssiValue	0x14	0x22
RegMcParam6	0x05	0xCF	RegRxParam6	0x15	0x00
RegR1	0x06	0x7D	RegSyncByte1	0x16	0xAA
RegP1	0x07	0x68	RegSyncByte2	0x17	0x0A
RegS1	0x08	0x46	RegSyncByte3	0x18	0x0B
RegR2	0x09	0x74	RegSyncByte4	0x19	0x0C
RegP2	0x0A	0x62	RegTxParam	0x1A	0x72
RegS2	0x0B	0x32	RegOscParam	0x1B	0x8C
RegParamP	0x0C	0x38	RegPktParam1	0x1C	0x02
RegIrqParam1	0x0D	0x08	RegNodeAddr	0x1D	0x00
RegIrqParam2	0x0E	0x1F	RegPktParam3	0x1E	0x60
RegRssiIrqThres	0x0F	0x00	RegPktParam4	0x1F	0xC0

General		Rx	
Band:	902-915 MHz	Passive filter fc:	378000 Hz
RF frequency:	908000000 Hz	Butterworth fc-to:	100000 Hz
Modulation scheme:	FSK	Polyphase fc:	100000 Hz
Frequency Deviation:	50000 Hz	Tx	
Bitrate:	25000 bps	Interpolator filter fc:	200000 Hz
Operating mode:	RECEIVER	Output power:	10 dBm

Figure 5. The New SX1211 Configuration: Ready to be Written

- By clicking on the write button in the 'Registers config' section, the new register values are written to the SX1211 registers. If successful, the red values in the hexadecimal register summary table will turn black. As a double check, the register read button may be pressed – the values presented on the user interface should remain unchanged.

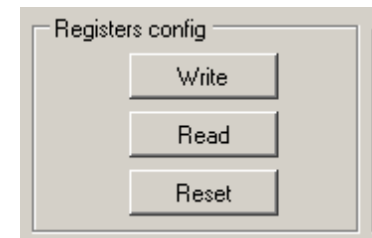

3.2 SX1211SKA Receive Mode Configuration

1. Click on the 'Packet' tab to access the packet testing portion of the program. Within this window a pre-defined packet structure is already configured. It remains simply to click the 'Reception' radio button and press the Start button. At this point the SX1211SKA enters packet receive mode and is now listening for valid packets. At this juncture another SX1211SKA must be configured as transmitter.

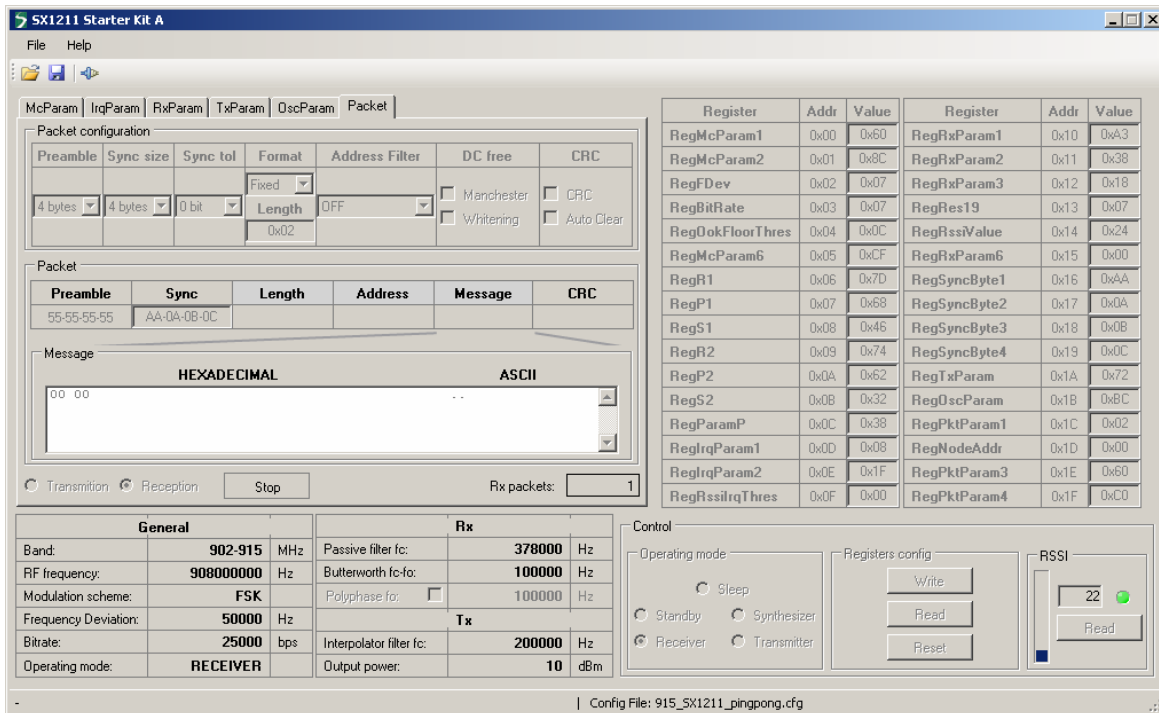

Figure 6. The SX1211SKA User Interface whilst in Packet Receiver Mode

3.3 SX1211SKA Transmit Mode Configuration

1. Repeat steps 1 to 9 of Section 3.1 with the second SX1211SKA provided in the kit. Then click on the 'Packet' tab.
2. The packet test display is preconfigured in transmit mode with a valid payload (see *Figure 7*). The 'Repeat value' may be edited according to the number of packets desired to be transmitted (leave equal to zero for continuous transmission).
3. Press the Start button. Packets will start to be sent, the 'Tx Packets' display indicating the number of packets sent.
4. The successful reception of packets will be indicated in the 'Rx packets' window of the receiver SX1211SKA.

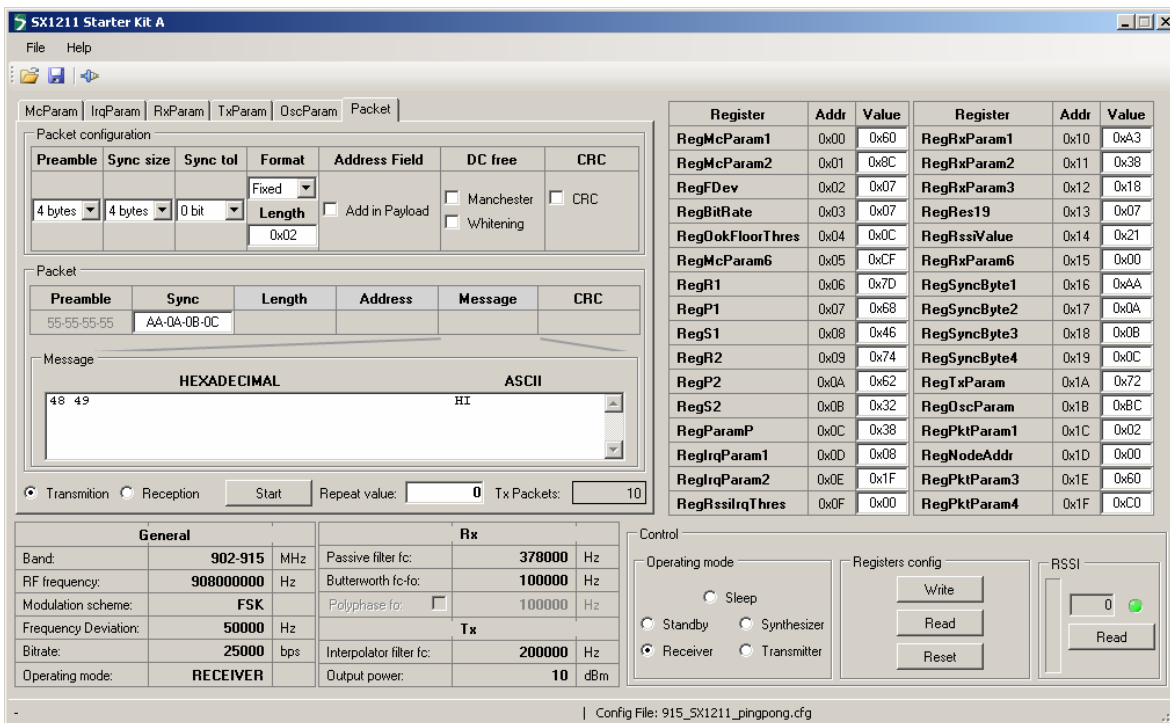

Figure 7. The SX1211SKA User Interface Ready to Transmit the Demonstration Packet

4 SX1211SXA Software Description

4.1 Overview

Figure 8 shows the SX1211SKA graphical user interface. Each of the numbers surrounding the display corresponds to the Chapter within this section which corresponds to the description of that GUI feature.

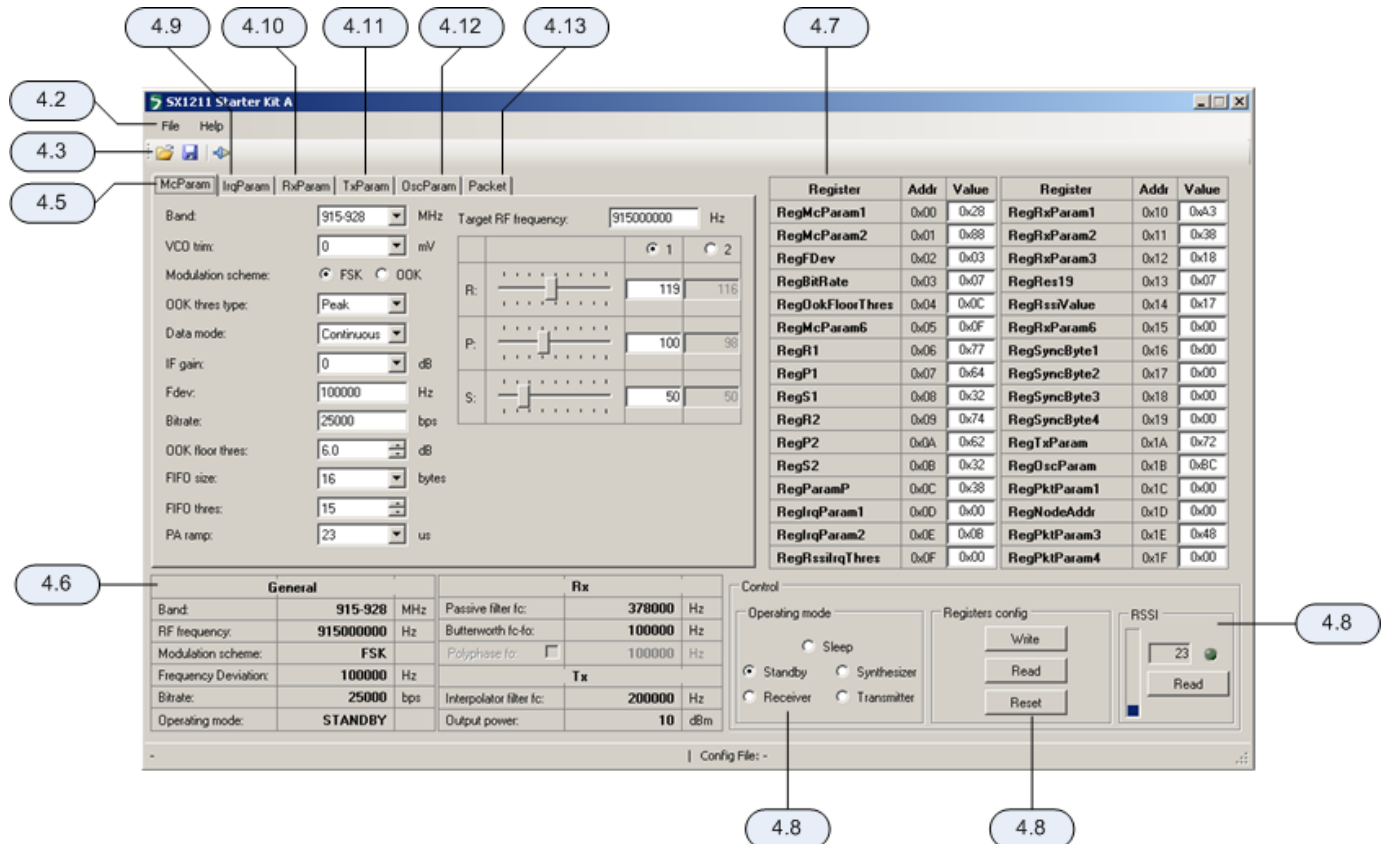
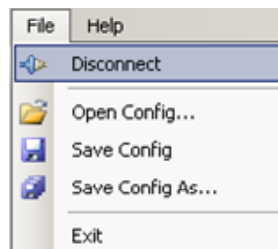

Figure 8. SX1211SKA GUI Overview and References to the User Guide Description of this Chapter

4.2 File Menu



File menu contains some general purpose functions. Some of them can also be accessed on the toolbar by clicking directly on the icon. The first feature in the list provides the possibility of connecting or disconnecting to the USB kit. Care must be taken to ensure that the USB port is closed before removing the USB kit. This functionality may also be accessed through the short cut buttons (see Section 4.3).

The possibility of opening configuration files and saving the present configuration is also provided. This is done through a standard Windows file dialog box.

The Help menu contains two menu items. The first item provides a link to this user guide in PDF format. The second, About SX1230 Starter kit..., gives information in the revision of the software installed.

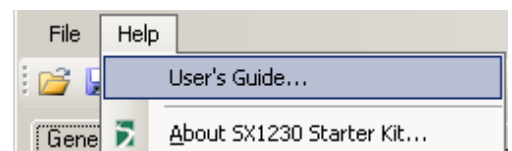

4.3 Shortcut Buttons

The shortcut buttons provide identical functionality to those listed under the file menu



The configuration file open shortcut button. This opens a windows file dialog box to allow access to previously saved SX1211 register configuration files.

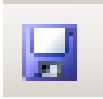

The save configuration file shortcut button immediately saves and overwrites the existing configuration file.



The connect / disconnect button allows the user to manage manually connection and disconnection of the kit. Note that any time the SX1211SKA is to be removed from the system; the kit must first be disconnected.

The saved configuration files are designed to be a useful tool for embedded software development. The file can be opened in any text editor to display the programmed register name, address and hexadecimal value programmed to that address.

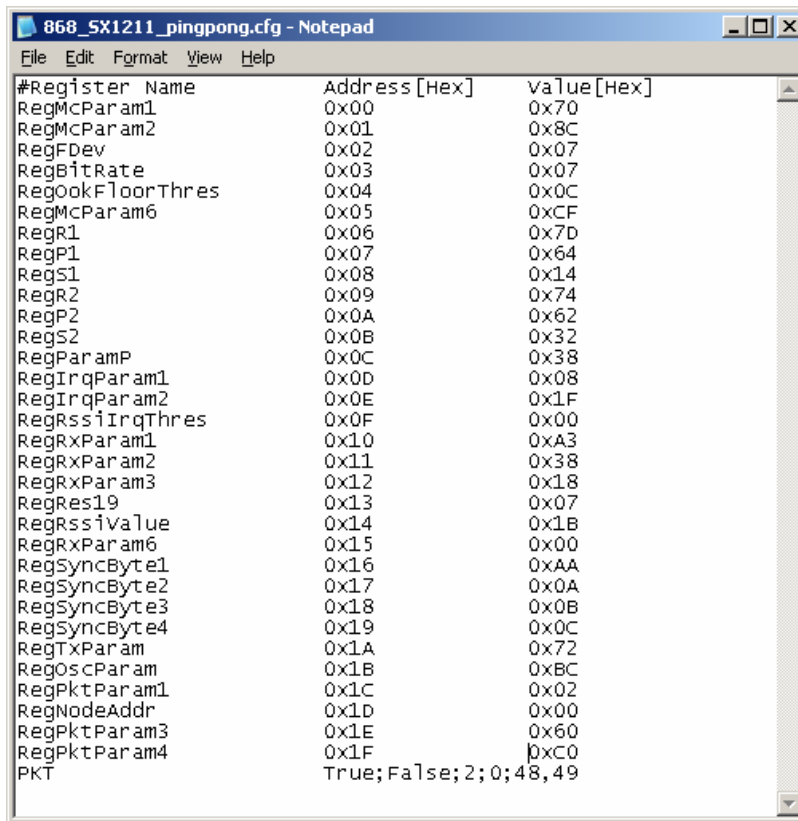

```

868_SX1211_pingpong.cfg - Notepad
File Edit Format View Help
#Register Name      Address [Hex]      Value [Hex]
RegMcParam1         0x00               0x70
RegMcParam2         0x01               0x8C
RegFDev             0x02               0x07
RegBitRate          0x03               0x07
RegOokFloorThres    0x04               0x0C
RegMcParam6         0x05               0xCF
RegR1               0x06               0x7D
RegP1               0x07               0x64
RegS1               0x08               0x14
RegR2               0x09               0x74
RegP2               0x0A               0x62
RegS2               0x0B               0x32
RegParamP          0x0C               0x38
RegIrqParam1        0x0D               0x08
RegIrqParam2        0x0E               0x1F
RegRssiIrqThres     0x0F               0x00
RegRxParam1         0x10               0xA3
RegRxParam2         0x11               0x38
RegRxParam3         0x12               0x18
RegRes19            0x13               0x07
RegRssiValue        0x14               0x1B
RegRxParam6         0x15               0x00
RegSyncByte1        0x16               0xAA
RegSyncByte2        0x17               0x0A
RegSyncByte3        0x18               0x0B
RegSyncByte4        0x19               0x0C
RegTxParam          0x1A               0x72
RegOscParam         0x1B               0xBC
RegPktParam1        0x1C               0x02
RegNodeAddr         0x1D               0x00
RegPktParam3        0x1E               0x60
RegPktParam4        0x1F               0xC0
PKT                  True;False;2;0;48,49
  
```

Figure 9. Example Text Editor Output of the SX1211 Configuration File

4.4 Text Field Conventions for the SX1211SKA

RF frequency: Hz

An orange background highlight indicates that the precise value entered into the data entry field is not directly addressable by the SX1211. Instead the closest (rounded) value will be used.

RF frequency: Hz

Conversely a red background highlight indicates where the maximum or minimum value for that register parameter has been exceeded.

4.5 McParam Tab

Band Selection

Band: MHz

One of the three operating bands for the SX1211 may be selected here. The SX1211SKA hardware is band specific and so the corresponding band should be selected.

VCO Voltage Trim

VCO trim: mV

In some designs the VCO voltage requires trimming. The SX1211SKA reference design does not require this function, but is included here for completeness.

Modulation Selection

Modulation scheme: FSK OOK

The SX1211 is capable of both FSK and OOK modulation, they are selectable through the user interface by clicking with the mouse on the appropriate radio button.

OOK Receiver Detection Type

OOK thres type:

Several modes of OOK detection are possible, please see the SX1211 datasheet for mode information on configuring the OOK receiver.

Data Mode

Data mode:

Three data modes are available for the SX1211, typically packet mode is selected automatically, requiring no user selection, upon launching the Packet Test (see Section 4.13).

Gain of the IF Stage

IF gain: dB

The gain of the intermediate frequency amplifier chain can be adjusted manually.

Frequency Deviation

Fdev: Hz

Text entry field for the frequency deviation when using FSK modulation.

Bit Rate

Bitrate: bps

The bit rate of the transmitted signal (in bps) can be directly edited in this data entry field.

Floor Threshold for OOK Detection

OOK floor thres: dB

Margin to the OOK demodulation threshold – see SX1211 datasheet for more details.

FIFO Settings

FIFO size: bytes
 FIFO thres:

Both the working size of the FIFO and the number of bytes it must store before generating a hardware interrupt are user defined. Again this functionality is largely automated in the packet test mode (Section 4.13).



PA Ramping

PA ramp: us

The PA ramp rise time is selectable from the list of programmable values.

Frequency of Operation

Target RF frequency: Hz

		<input checked="" type="radio"/> 1	<input type="radio"/> 2
R:		<input type="text" value="119"/>	<input type="text" value="116"/>
P:		<input type="text" value="100"/>	<input type="text" value="98"/>
S:		<input type="text" value="50"/>	<input type="text" value="50"/>

The frequency of operation of the SX1211 is a set by three frequency divider ratios (see Figure 10). Based upon the frequency of the crystal oscillator and the values of these divider ratios the local oscillator frequency may be determined.

To simplify this process, the SX1211SKA user interface sees this process completely automated. By entering the desired operating frequency in the text field at the top of the display, the resultant R, P and S divider ratios are calculated (see the SX1211 datasheet for information on their calculation).

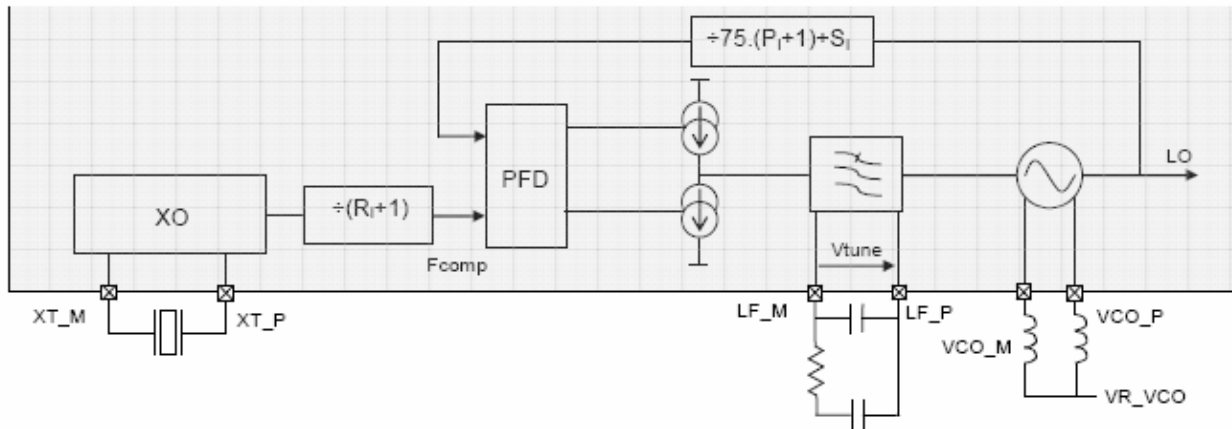

Figure 10. SX1211 Local Oscillator Generation

4.6 Overview Panel

A summary of the values presently entered into the user interface software is shown in the overview display at the bottom of the screen. This is sub-divided into three sections pertaining to: general configuration, transmitter settings and receiver parameters.

General			Rx		
Band:	915-928	MHz	Passive filter fc:	378000	Hz
RF frequency:	915000000	Hz	Butterworth fc-fo:	100000	Hz
Modulation scheme:	FSK		Polyphase fo: <input type="checkbox"/>	100000	Hz
Frequency Deviation:	100000	Hz	Tx		
Bitrate:	25000	bps	Interpolator filter fc:	200000	Hz
Operating mode:	STANDBY		Output power:	10	dBm

Figure 11. The Overview Panel

4.7 Register Hexadecimal Display

Figure 12 shows the register summary of the SX1211. In addition to manual user entry in the fields described in the previous section, direct hexadecimal entries may be made into the register display. Note that values yet to be written to the SX1211 registers appear in red. Note, also, that for full control flexibility, incorrect (red) values entered in the hexadecimal section *will still be written* in the event of a register 'write'. So care must be exercised when editing the hexadecimal values.

Register	Addr	Value	Register	Addr	Value
RegMcParam1	0x00	0x28	RegRxParam1	0x10	0xA3
RegMcParam2	0x01	0x88	RegRxParam2	0x11	0x38
RegFDev	0x02	0x03	RegRxParam3	0x12	0x18
RegBitRate	0x03	0x07	RegRes19	0x13	0x07
RegOokFloorThres	0x04	0x0C	RegRssiValue	0x14	0x00
RegMcParam6	0x05	0x0F	RegRxParam6	0x15	0x00
RegR1	0x06	0x8F	RegSyncByte1	0x16	0x00
RegP1	0x07	0x79	RegSyncByte2	0x17	0x00
RegS1	0x08	0x14	RegSyncByte3	0x18	0x00
RegR2	0x09	0x74	RegSyncByte4	0x19	0x00
RegP2	0x0A	0x62	RegTxParam	0x1A	0x72
RegS2	0x0B	0x32	RegOscParam	0x1B	0xBC
RegParamP	0x0C	0x38	RegPktParam1	0x1C	0x00
RegIrqParam1	0x0D	0x00	RegNodeAddr	0x1D	0x00
RegIrqParam2	0x0E	0x09	RegPktParam3	0x1E	0x48
RegRssiIrqThres	0x0F	0x00	RegPktParam4	0x1F	0x00

Figure 12. The Hexadecimal Register Display Summary

4.8 The Mode Control Box

The mode control box is sub-divided into three sections. The first 'Operating mode' allows the user to change the operating mode of the SX1211 by clicking on the radio button corresponding to the desired mode. Note that the transition between modes is instantaneous. The centre section, 'Registers config' allows the register settings entered elsewhere in the user interface to be written to the configuration registers of the SX1211 by clicking the write button. The read operation will read the configuration registers and refresh the user interface display with the values read from the SX1211.

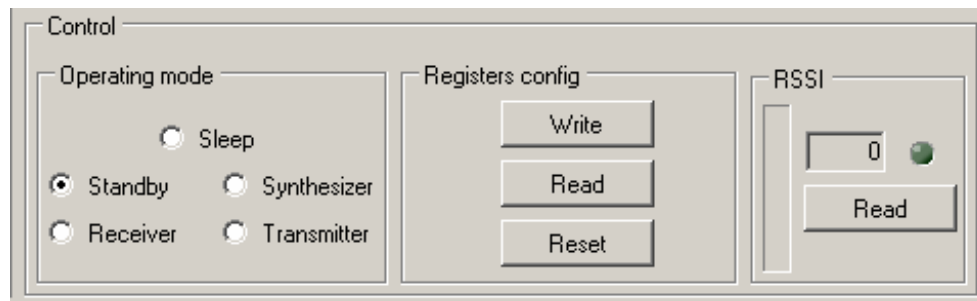

Figure 13. The Mode Control Box also Incorporates RSSI

The third, rightmost, section of the mode control box allows an instantaneous RSSI (received signal strength indicator) measurement. Please note that this feature is only accessible when the SX1211 is in the receiver operating mode.

4.9 The IrqParam Tab

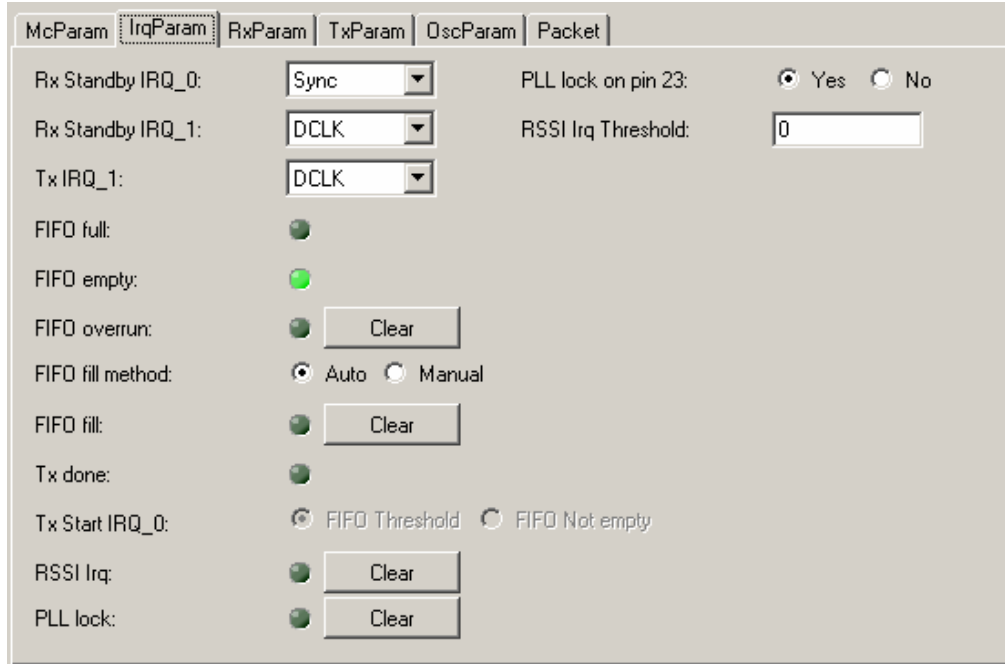

Figure 14. The Interrupt Mapping Display

For total register coverage by the user interface, the interrupt mapping for the SX1211 can be controlled through the configuration of the IrqParam display. Note, however, that the hardware interrupt feature is not used directly by the GUI. For further information please see the corresponding register descriptions in the SX1211 datasheet and the PCB layout and schematics of Section 5.

4.10 The RxParam Tab

The receiver parameter field provides full access to all of the software configurable settings of the SX1211. For reference, a simplified block schematic of the SX1211 receiver is shown in figure Figure 15. The settings configurable in the receiver parameter tab correspond to the programmable baseband receiver functions.

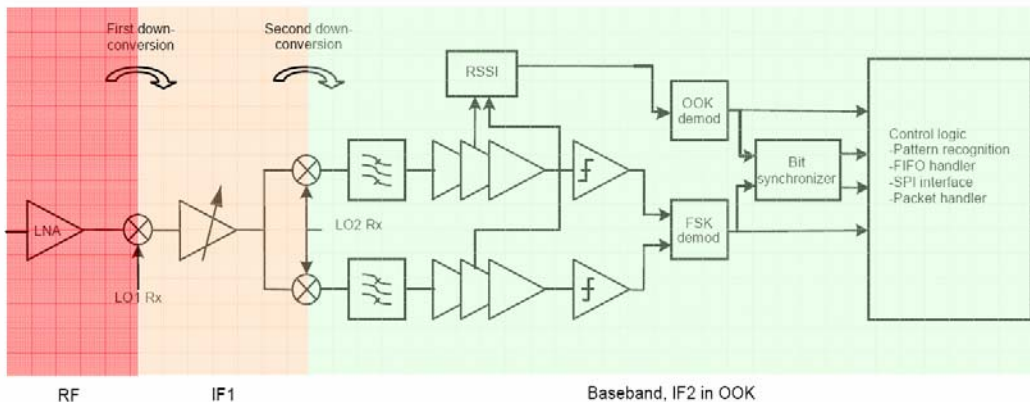
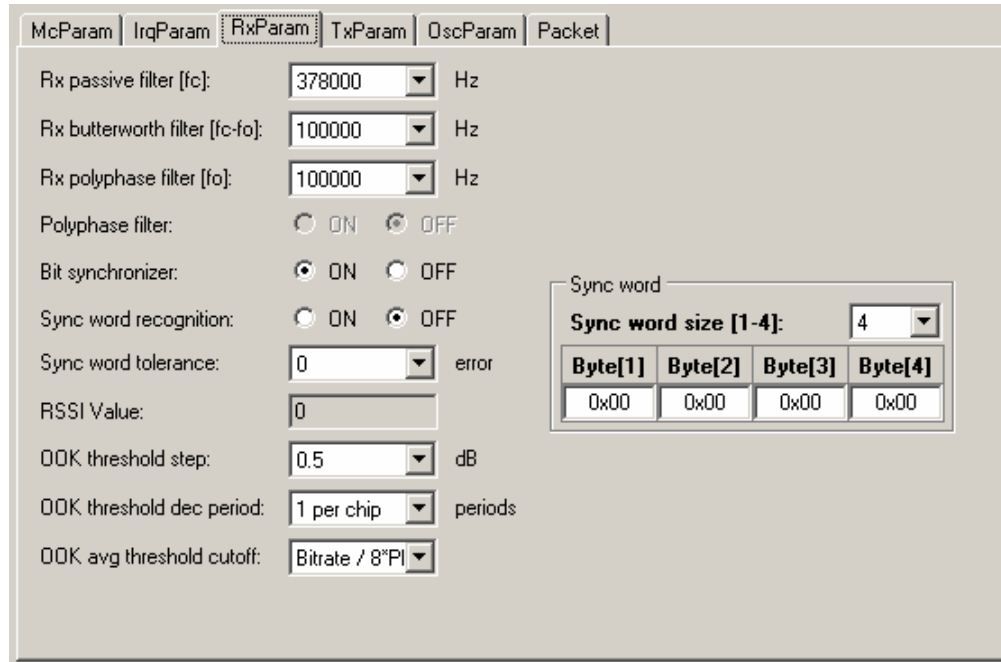

Figure 15. SX1211 Receiver Block Diagram, the Colours Correspond to the Frequency of Operation.



The screenshot shows the 'RxParam' tab of a configuration interface. It contains the following settings:

- Rx passive filter [fc]: 378000 Hz
- Rx butterworth filter [fc-fo]: 100000 Hz
- Rx polyphase filter [fo]: 100000 Hz
- Polyphase filter: ON OFF
- Bit synchronizer: ON OFF
- Sync word recognition: ON OFF
- Sync word tolerance: 0 error
- RSSI Value: 0
- OOK threshold step: 0.5 dB
- OOK threshold dec period: 1 per chip periods
- OOK avg threshold cutoff: Bitrate / 8*PI

A 'Sync word' sub-panel is also visible, containing:

- Sync word size [1-4]: 4
- Byte[1]: 0x00
- Byte[2]: 0x00
- Byte[3]: 0x00
- Byte[4]: 0x00

Figure 16. Receiver Parameter Display

For a complete description of the functionality of the receiver section please consult the SX121 datasheet. However, the principle fields of interest for general use are:

Rx Filters:

The first three text entry fields of the receiver parameters correspond to the baseband filtering section. Note that the Butterworth filter is the narrowest of the three filters and determines the receiver channel bandwidth.

Bit Synchroniser:

This block performs timing recovery and synchronises the decision on whether a given bit is logical high or low based upon the received bit stream. This block yields a substantial improvement in receiver sensitivity performance and it is hence recommended that it be left enabled.

Sync Word:

The synchronisation word is applicable to operation in buffered and packet modes. For packet mode operation the sync word is set using the packet editor – this may be found in the 'Packet' Tab (Section 4.13). Link testing by the SX1211SKA is done in packet mode only – sync word provision is made here for completeness.

OOK Settings:

OOK demodulation is based upon measurements from the RSSI block and there are a rich variety of settings for how the OOK signal is detected and processed. These techniques and the corresponding settings are given a detailed treatment in the SX1211 datasheet.

4.11 The TxParam Tab

The transmitter configuration of the SX1211 is shown in Figure 17. This shows that the modulating signal is generated by direct digital synthesis (DDS), unconverted through the superheterodyne mixer stages and then amplified by a power amplifier chain.

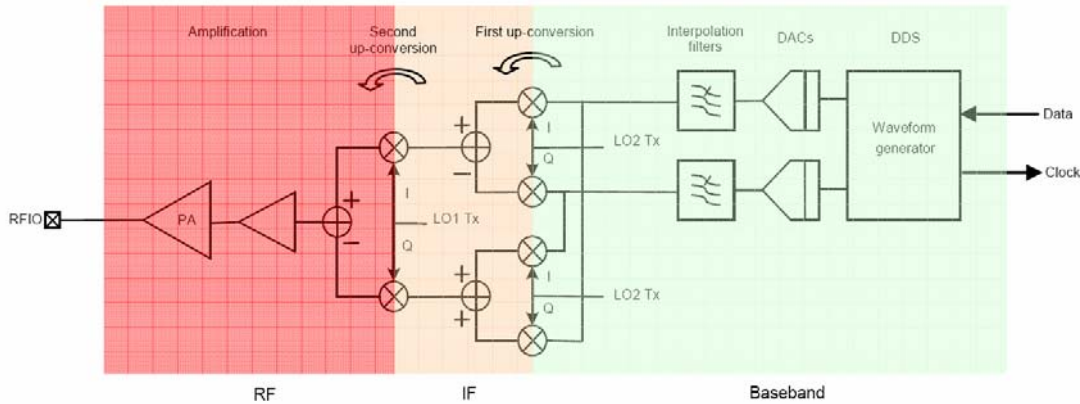

Figure 17. SX1211 Simplified Transmitter Block Schematic Diagram

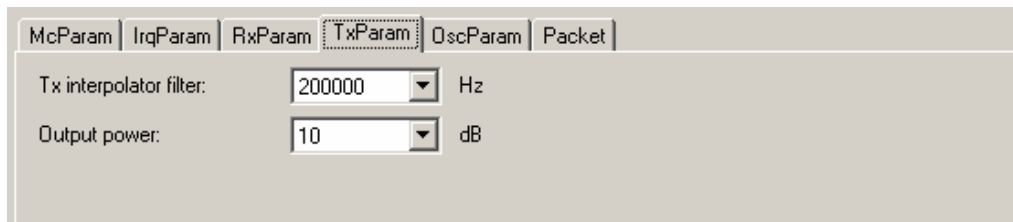

Figure 18. The Transmitter Parameter Tab Display

The two parameters which are configurable for transmit operation of the SX121 are:

Output Power:

The output power of the SX1211 can be programmed in 3 dB steps. Valid programmable powers are selected from a drop-down list of valid values.

Interpolation Filter Setting:

The DDS output requires filtering to remove the spuri common in the generation of signals through this technique; this is performed by the interpolation filters. The cut-off frequency of the interpolation filters can be selected from the drop down menu of valid values. The technique for calculating the cut-off frequency may be found in the SX1211 datasheet.

4.12 The OscParam Tab

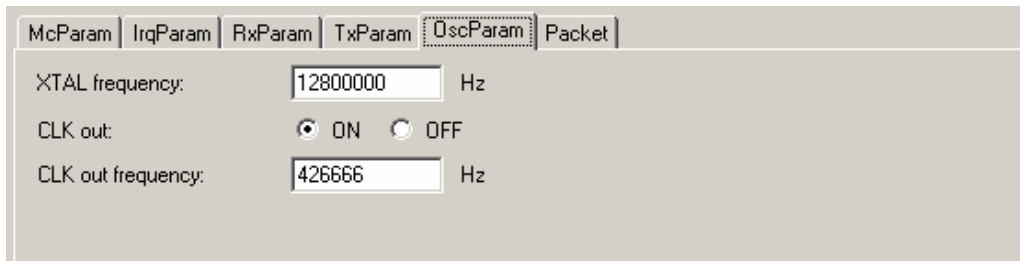

Figure 19. The Oscillator Parameter Display

The oscillator parameter display gives access to the clock output functionality. This can be enabled or disabled and the frequency changed by entering a value in the 'CLK out frequency' text field. Note also that there is provision to change the frequency of the crystal. Changing of the crystal frequency has a knock on effect on all parameters that are a function of the reference frequency, for example bit rate, filter settings, RF output frequency. The SX1211SKA is fitted with the 12.8 MHz crystal recommended in the SX1211 reference design. For this reason the crystal value should, typically, be left unchanged.

4.13 The Packet Test Tab

The 'Packet' tab is the principle interface for conducting transmission or reception testing. The display, as shown in Figure 18 is divided into three horizontal portions. The top portion of the display is given to the packet editor. Here the configuration of the packet, either to be transmitted or received by the SX1211SKA is constructed.

The packet layout contains all of the features described in the SX1211 datasheet. This includes:

Preamble

This input allows the user enable and set the length of a pulse train preamble (sent at the data rate).

Sync word size

A custom synchronisation word of up to 4 bytes may also be added.

Sync tol

The number of errors which may be accommodated in the sync word (bits), before the packet is rejected.

Format / Length / Address

Fixed or variable length packets may also be stipulated (see the SX1211 datasheet for more information), as may an optional 1 byte address.

Digital Coding

Optional channel coding including CRC, data whitening and Manchester coding are also available.

With these options entered the constructed packet is shown in the 'Packet' frame. Where the SX1211SKA is to be used in transmit mode, the packet payload may also be edited in either ASCII or hexadecimal. Packet transmission is enabled by selecting the 'Transmission' radio button. This starts when the 'Start' button is pressed. Either infinite transmission (repeat value = 0) or a finite number of packets may be transmitted by editing the repeat value.

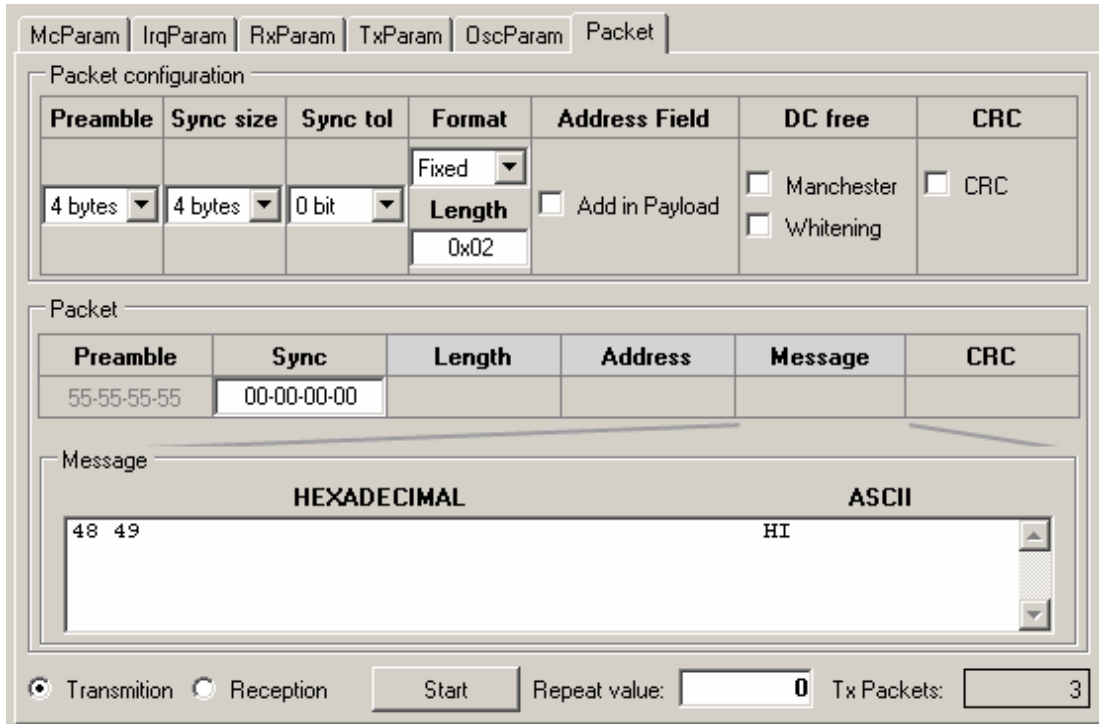

Figure 20. The Packet Receiver / Transmitter Test Display

For receive mode, the normal mode of operation in conjunction with the SX1230SKA, the reception the 'Reception' radio button is selected and the start button pressed. From this moment the SX1211 is placed in receive mode and listens continuously for a packet corresponding to the format entered in the packet editor. Upon successful reception, the payload received is shown in the 'Message Box' and the number of received packets is incremented. For indication of the signal strength received by the SX1211SKA, the RSSI display (see Section 4.8) is activated and continuously refreshed.

By way of example, Figure 21 shows the entire user interface display whilst receiving a valid packet payload.

The screenshot shows the 'SX1211 Starter Kit A' software interface. The 'Packet' tab is selected, showing packet configuration and reception details.

Packet configuration:

Preamble	Sync size	Sync tol	Format	Address Filter	DC free	CRC
4 bytes	4 bytes	0 bit	Fixed Length: 0x02	OFF	<input type="checkbox"/> Manchester <input type="checkbox"/> Whitening	<input type="checkbox"/> CRC <input type="checkbox"/> Auto Clear

Packet:

Preamble	Sync	Length	Address	Message	CRC
55-55-55-55	AA-0A-0B-0C				

Message:

HEXADECIMAL: 48 49
 ASCII: HI

Transmission: Reception: Stop [] Rx packets: 128

General:

Band:	902-915 MHz	Passive filter fc:	378000 Hz
RF frequency:	908000000 Hz	Butterworth fc-fa:	100000 Hz
Modulation scheme:	FSK	Polyphase fa:	<input type="checkbox"/> 100000 Hz
Frequency Deviation:	50000 Hz	Tx	
Bitrate:	25000 bps	Interpolator filter fc:	200000 Hz
Operating mode:	RECEIVER	Output power:	10 dBm

Control:

Operating mode: Sleep, Standby, Synthesizer, Receiver, Transmitter

Registers config: Write [], Read [], Reset []

RSSI: 132 [] Read []

Config File: 915_SX1211_pingpong.cfg

Figure 21. Software Display: Successful Packet Mode Reception

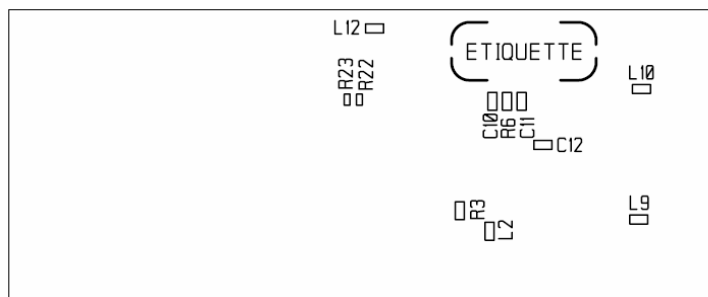
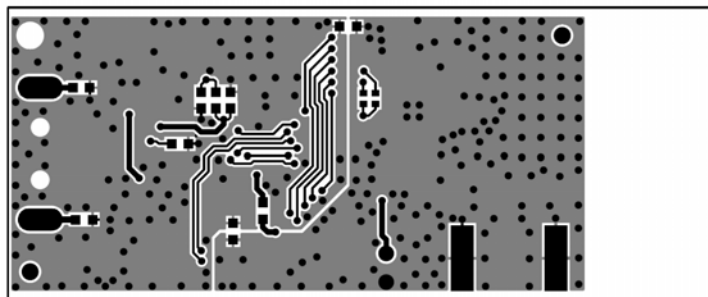
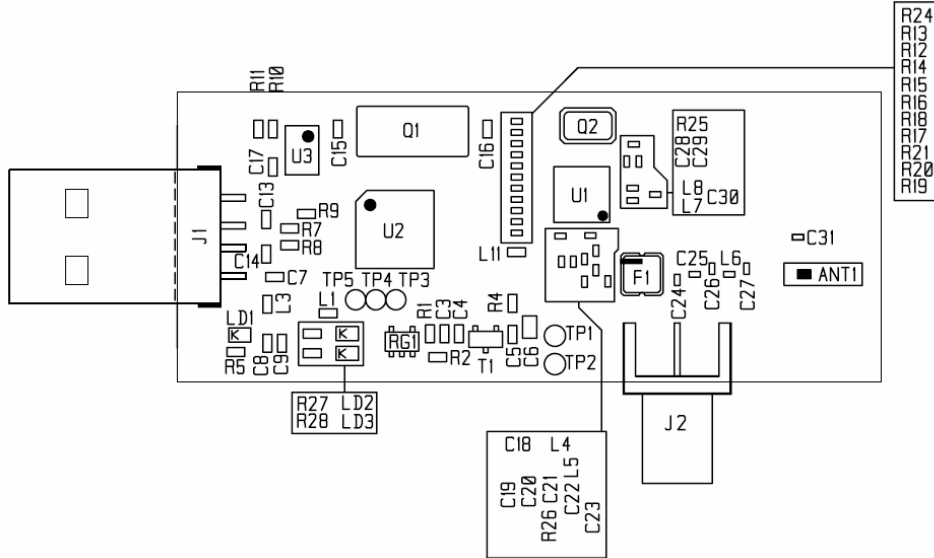
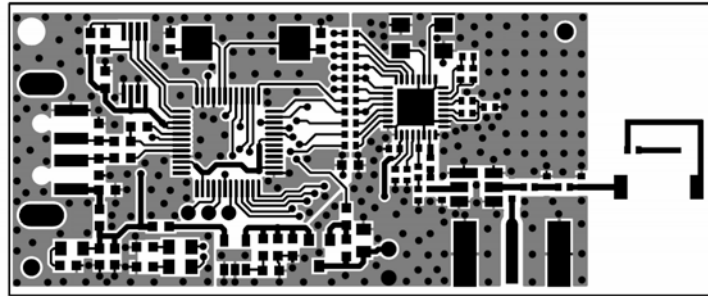

6 References

- [1] SX1211 Datasheet

© Semtech 2008

All rights reserved. Reproduction in whole or in part is prohibited without the prior written consent of the copyright owner. The information presented in this document does not form part of any quotation or contract, is believed to be accurate and reliable and may be changed without notice. No liability will be accepted by the publisher for any consequence of its use. Publication thereof does not convey nor imply any license under patent or other industrial or intellectual property rights. Semtech assumes no responsibility or liability whatsoever for any failure or unexpected operation resulting from misuse, neglect improper installation, repair or improper handling or unusual physical or electrical stress including, but not limited to, exposure to parameters beyond the specified maximum ratings or operation outside the specified range.

SEMTECH PRODUCTS ARE NOT DESIGNED, INTENDED, AUTHORIZED OR WARRANTED TO BE SUITABLE FOR USE IN LIFE-SUPPORT APPLICATIONS, DEVICES OR SYSTEMS OR OTHER CRITICAL APPLICATIONS. INCLUSION OF SEMTECH PRODUCTS IN SUCH APPLICATIONS IS UNDERSTOOD TO BE UNDERTAKEN SOLELY AT THE CUSTOMER'S OWN RISK. Should a customer purchase or use Semtech products for any such unauthorized application, the customer shall indemnify and hold Semtech and its officers, employees, subsidiaries, affiliates, and distributors harmless against all claims, costs damages and attorney fees which could arise.

Contact Information

Semtech Corporation
Advanced Communications and Sensing Products Division
200 Flynn Road, Camarillo, CA 93012
Phone: (805) 498-2111 Fax: (805) 498-3804