

FEATURES

- 3 kV rms signal and power isolated CAN transceiver**
- isoPower* integrated isolated dc-to-dc converter**
- V_{IO} pin for 1.7 V to 5.5 V logic levels**
- ISO 11898-2:2016 compliant (CAN FD)**
- Data rates up to 12 Mbps for CAN FD**
- Low maximum loop propagation delay: 150 ns**
- Extended common-mode range (V_{CANx}): ±25 V**
- Bus fault protection: ±40 V on CANH and CANL pins**
- Low power standby support remote wake request**
- Extra isolated signal for control (such as termination switches)**
- Passes EN 55022 Class B by 6 dB**
- Slope control for reduced EMI**
- Safety and regulatory approvals**

VDE certificate of conformity, VDE V 0884-10 (pending)

V_{IORM} = 849 V_{PEAK}

UL: 5000 V rms for 1 minute per UL 1577 (pending)

CSA Component Acceptance Notice 5A (pending)

IEC 60950-1, IEC 61010-1

Creepage and clearance

7.8 mm minimum with 20-lead SOIC_W

High common-mode transient immunity: >75 kV/μs

ENHANCED PRODUCT FEATURES

- Supports defense and aerospace applications (AQEC standard)**
- Military temperature range: -55°C to +105°C**
- Controlled manufacturing baseline**
- 1 assembly/test site**
- Product change notification**
- Qualification data available on request**

APPLICATIONS

- CANOpen, DeviceNet, and other CAN bus implementations**
- Industrial automation**
- Military and aerospace (MILA) avionics for sensors, actuators, and engine control**

GENERAL DESCRIPTION

The ADM3057E-EP is a 3 kV rms isolated controller area network (CAN) physical layer transceiver with integrated isolated dc-to-dc converter. The ADM3057E-EP meets flexible data rate (CAN FD) requirements for operation to 5 Mbps and higher and complies with the ISO 11898-2: 2016 standard. The ADM3057E-EP is capable of supporting data rates as high as 12 Mbps.

The device employs Analog Devices, Inc., *iCoupler*® technology to combine a 3-channel isolator, a CAN transceiver, and an Analog Devices *isoPower*® dc-to-dc converter into a single, surface-mount,

FUNCTIONAL BLOCK DIAGRAM

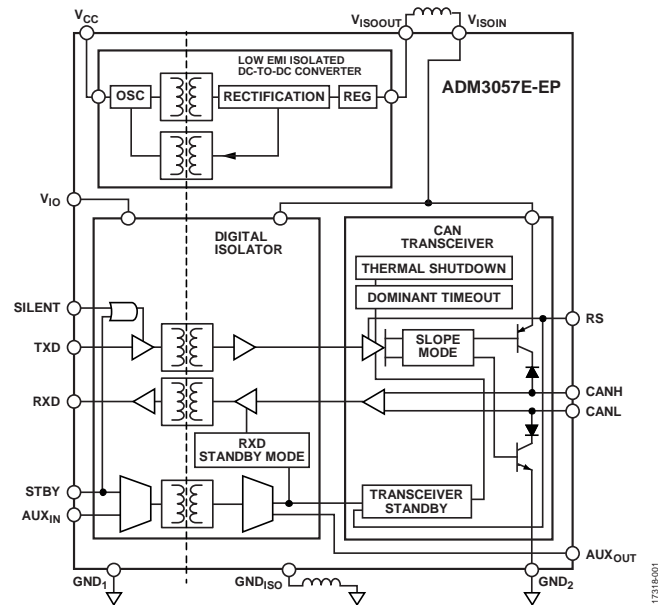

Figure 1.

small outline integrated circuit (SOIC) package. The device is powered by a single 5 V supply, realizing a fully isolated solution for CAN and CAN FD. Radiated emissions from the high frequency switching of the dc-to-dc converters are kept below EN 55022 Class B limits by continuous adjustments to the switching frequency.

The ADM3057E-EP provides complete isolation between the CAN controller and physical layer bus. Safety and regulatory approvals (pending) for 3 kV rms isolation voltage, 10 kV surge test, and 7.8 mm creepage and clearance ensure the ADM3057E-EP meets application reinforced isolation requirements.

Low propagation delays through the isolation support longer bus cables. Slope control mode is available for standard CAN at low data rates. Standby mode minimizes power consumption when the bus is idle or if the node goes offline. Silent mode allows the TXD input to be ignored for listen only mode.

Dominant timeout functionality protects against bus lockup in a fault condition. The current limiting and thermal shutdown features protect against output short circuits. The device is fully specified over a temperature range of -55°C to +105°C.

Additional application and technical information can be found in the [ADM3057E](#) data sheet.

Rev. 0

[Document Feedback](#)

Information furnished by Analog Devices is believed to be accurate and reliable. However, no responsibility is assumed by Analog Devices for its use, nor for any infringements of patents or other rights of third parties that may result from its use. Specifications subject to change without notice. No license is granted by implication or otherwise under any patent or patent rights of Analog Devices. Trademarks and registered trademarks are the property of their respective owners.

TABLE OF CONTENTS

| | | | |
|--|---|--|----|
| Features | 1 | DIN V VDE V 0884-10 (VDE V 0884-10) Insulation | |
| Enhanced Product Features | 1 | Characteristics | 9 |
| Applications..... | 1 | Absolute Maximum Ratings | 10 |
| General Description | 1 | Thermal Resistance | 10 |
| Functional Block Diagram | 1 | ESD Caution..... | 10 |
| Revision History | 2 | Pin Configuration and Function Descriptions..... | 11 |
| Specifications..... | 3 | Operational Truth Table | 12 |
| Timing Specifications | 5 | Typical Performance Characteristics | 13 |
| Insulation and Safety Related Specifications | 7 | Test Circuits..... | 17 |
| Package Characteristics | 7 | Outline Dimensions | 18 |
| Regulatory Information..... | 8 | Ordering Guide | 18 |

REVISION HISTORY

2/2019—Revision 0: Initial Version

SPECIFICATIONS

All voltages are relative to their respective ground. $4.5\text{ V} \leq V_{CC} \leq 5.5\text{ V}$, $1.7\text{ V} \leq V_{IO} \leq 5.5\text{ V}$, $-55^\circ\text{C} \leq T_A \leq +105^\circ\text{C}$, and STBY low, unless otherwise noted. Typical specifications are at $V_{CC} = V_{IO} = 5\text{ V}$ and $T_A = 25^\circ\text{C}$, unless otherwise noted.

Table 1.

| Parameter | Symbol | Min | Typ | Max | Unit | Test Conditions/Comments |
|---|----------------------------|----------------------|------|----------------------|---------------|---|
| SUPPLY CURRENT | | | | | | |
| Logic Side <i>iso</i> Power Current Standby | I_{CC} | | 13.5 | 30 | mA | STBY high, AUX _{IN} low, load resistance (R_L) = 60 Ω |
| Recessive State (or Silent) Dominant State | | | 27 | 40 | mA | TXD and/or SILENT high, $R_L = 60\ \Omega$ |
| 70% Dominant/30% Recessive | | | 180 | 260 | mA | Fault condition, $R_L = 60\ \Omega$ |
| 1 Mbps | | | 138 | | mA | Worst case, $R_L = 60\ \Omega$ |
| 5 Mbps | | | 151 | 200 | mA | |
| 12 Mbps | | | 177 | 220 | mA | |
| Switching Frequency | f_{OSC} | | 180 | | MHz | Frequency hopping center |
| Logic Side <i>i</i> Coupler Current | I_{IO} | | | | | |
| Normal Mode | | | 3.6 | 5 | mA | TXD high, low or switching, AUX _{IN} low |
| Standby Mode | | | 1.2 | 2 | mA | STBY high |
| DRIVER | | | | | | |
| Differential Outputs | | | | | | See Figure 27 |
| Recessive State, Normal Mode | | | | | | TXD high, R_L and common-mode filter capacitor (C_F) open |
| CANH, CANL Voltage | V_{CANL} , V_{CANH} | 2.0 | | 3.0 | V | |
| Differential Output Voltage | V_{OD} | -500 | | +50 | mV | |
| Dominant State, Normal Mode | | | | | | TXD and SILENT low, C_F open |
| CANH Voltage | V_{CANH} | 2.75 | | 4.5 | V | $50\ \Omega \leq R_L \leq 65\ \Omega$ |
| CANL Voltage | V_{CANL} | 0.5 | | 2.0 | V | $50\ \Omega \leq R_L \leq 65\ \Omega$ |
| Differential Output Voltage | V_{OD} | 1.5 | | 3.0 | V | $50\ \Omega \leq R_L \leq 65\ \Omega$ |
| | | 1.4 | | 3.3 | V | $45\ \Omega \leq R_L \leq 70\ \Omega$ |
| | | 1.5 | | 5.0 | V | $R_L = 2240\ \Omega$ |
| Standby Mode | | | | | | STBY high, R_L and C_F open |
| CANH, CANL Voltage | V_{CANL} , V_{CANH} | -0.1 | | +0.1 | V | |
| Differential Output Voltage | V_{OD} | -200 | | +200 | mV | |
| Output Symmetry ($V_{ISOIN} - V_{CANH} - V_{CANL}$) | V_{SYM} | -0.55 | | +0.55 | V | $R_L = 60\ \Omega$, $C_F = 4.7\text{ nF}$, RS low |
| Short-Circuit Current | $ I_{SC} $ | | | | | R_L open |
| Absolute | | | | | | |
| CANH | | | | 115 | mA | $V_{CANH} = -3\text{ V}$ |
| CANL | | | | 115 | mA | $V_{CANL} = 18\text{ V}$ |
| Steady State | | | | | | |
| CANH | | | | 115 | mA | $V_{CANH} = -24\text{ V}$ |
| CANL | | | | 115 | mA | $V_{CANL} = 24\text{ V}$ |
| Logic Inputs (TXD, SILENT, STBY, AUX _{IN}) | | | | | | |
| Input Voltage | | | | | | |
| High | V_{IH} | $0.65 \times V_{IO}$ | | | V | |
| Low | V_{IL} | | | $0.35 \times V_{IO}$ | V | |
| Complementary Metal-Oxide Semiconductor (CMOS) Logic | $ I_{IH} , I_{IL} $ | | | 10 | μA | Input high or low |
| Input Currents | | | | | | |

| Parameter | Symbol | Min | Typ | Max | Unit | Test Conditions/Comments |
|---|--------------------|----------------|-----|-------|-------------------|---|
| RECEIVER | | | | | | |
| Differential Inputs | | | | | | |
| Differential Input Voltage Range | V_{ID} | | | | | See Figure 28, C_{RXD} open, $-25\text{ V} < V_{CANL}, V_{CANH} < +25\text{ V}$ |
| Recessive | | -1.0 | | +0.5 | V | |
| Dominant | | -1.0 | | +0.4 | V | STBY high |
| Dominant | | 0.9 | | 5.0 | V | |
| Dominant | | 1.15 | | 5.0 | V | STBY high |
| Input Voltage Hysteresis | V_{HYS} | | 150 | | mV | |
| Unpowered Input Leakage Current | $ I_{IN(OFF)} $ | | | 10 | μA | $V_{CANH}, V_{CANL} = 5\text{ V}, V_{CC} = 0\text{ V}$ |
| Input Resistance | | | | | | |
| CANH, CANL | R_{INH}, R_{INL} | 6 | | 25 | $\text{k}\Omega$ | |
| Differential | R_{DIFF} | 20 | | 100 | $\text{k}\Omega$ | |
| Matching | m_R | -0.03 | | +0.03 | Ω/Ω | $m_R = 2 \times (R_{INH} - R_{INL}) / (R_{INH} + R_{INL})$ |
| Input Capacitance | | | | | | |
| CANH, CANL | C_{INH}, C_{INL} | | 35 | | pF | |
| Differential | C_{DIFF} | | 12 | | pF | |
| Logic Outputs (RXD, AUX _{OUT}) | | | | | | |
| Output Voltage | | | | | | |
| Low | V_{OL} | | 0.2 | 0.4 | V | Output current (I_{OUT}) = 2 mA |
| High | V_{OH} | | | | V | |
| RXD | | $V_{IO} - 0.2$ | | | V | $I_{OUT} = -2\text{ mA}$ |
| AUX _{OUT} | | +2.4 | | | V | $I_{OUT} = -2\text{ mA}$ |
| Short-Circuit Current | | | | | | |
| RXD | I_{OS} | 7 | | 85 | mA | Output voltage (V_{OUT}) = GND ₁ or V_{IO} |
| COMMON-MODE TRANSIENT IMMUNITY¹ | | | | | | |
| Input High, Recessive | $ CM_H $ | 75 | 100 | | kV/ μs | Common-mode voltage (V_{CM}) $\geq 1\text{ kV}$, transient magnitude $\geq 800\text{ V}$ $V_{IN} = V_{IO}$ (AUX _{IN} , TXD) or CANH/CANL recessive |
| Input Low, Dominant | $ CM_L $ | 75 | 100 | | kV/ μs | $V_{IN} = 0\text{ V}$ (AUX _{IN} , TXD) or CANH/CANL dominant |
| SLOPE CONTROL | | | | | | |
| Input Voltage for Standby Mode | V_{STB} | 4.0 | | | V | |
| Current for Slope Control Mode | I_{SLOPE} | | | -240 | μA | RS voltage (V_{RS}) = 0 V |
| Slope Control Mode Voltage | V_{SLOPE} | 2.1 | | | V | RS current (I_{RS}) = 10 μA |
| Input Voltage for High Speed Mode | V_{HS} | | | 1 | V | |

¹ $|CM_H|$ is the maximum common-mode voltage slew rate that can be sustained while maintaining AUX_{OUT} $\geq 2.4\text{ V}$, CANH/CANL recessive, or RXD $\geq V_{IO} - 0.2\text{ V}$. $|CM_L|$ is the maximum common-mode voltage slew rate that can be sustained while maintaining AUX_{OUT} $\leq 0.4\text{ V}$, CANH/CANL dominant, or RXD $\leq 0.4\text{ V}$. The common-mode voltage slew rates apply to both rising and falling common-mode voltage edges.

TIMING SPECIFICATIONS

All voltages are relative to their respective ground. $4.5\text{ V} \leq V_{CC} \leq 5.5\text{ V}$, $1.7\text{ V} \leq V_{IO} \leq 5.5\text{ V}$, $-55^\circ\text{C} \leq T_A \leq +105^\circ\text{C}$, and STBY low, unless otherwise noted. Typical specifications are at $V_{CC} = V_{IO} = 5\text{ V}$ and $T_A = 25^\circ\text{C}$, unless otherwise noted.

Table 2.

| Parameter | Symbol | Min | Typ | Max | Unit | Test Conditions/Comments |
|---|--------------------------|------|-----|------|------------------|--|
| DRIVER | | | | | | |
| Maximum Data Rate | | 12 | | | Mbps | SILENT low, bit time on the TXD pin as transmitted by the CAN controller ($t_{\text{BIT_TXD}} = 200\text{ ns}$, see Figure 2 and Figure 29, slope resistance ($R_{\text{SLOPE}} = 0\ \Omega$, $R_L = 60\ \Omega$, load capacitance ($C_L = 100\text{ pF}$) |
| Propagation Delay from TXD to Bus (Recessive to Dominant) | $t_{\text{TXD_DOM}}$ | | 35 | 60 | ns | |
| Propagation Delay from TXD to Bus (Dominant to Recessive) | $t_{\text{TXD_REC}}$ | | 46 | 70 | ns | |
| Transmit Dominant Timeout | t_{DT} | 1175 | | 4000 | μs | TXD low, see Figure 5 |
| RECEIVER | | | | | | |
| Falling Edge Loop Propagation Delay (TXD to RXD) | $t_{\text{LOOP_FALL}}$ | | | | | SILENT low, see Figure 2 and Figure 29, $R_L = 60\ \Omega$, $C_L = 100\text{ pF}$, RXD capacitance ($C_{\text{RXD}} = 15\text{ pF}$) |
| Full Speed Mode | | | | 150 | ns | $R_{\text{SLOPE}} = 0\ \Omega$, $t_{\text{BIT_TXD}} = 200\text{ ns}$ |
| Slope Control Mode | | | | 300 | ns | $R_{\text{SLOPE}} = 47\text{ k}\Omega$, $t_{\text{BIT_TXD}} = 1\ \mu\text{s}$ |
| Rising Edge Loop Propagation Delay (TXD to RXD) | $t_{\text{LOOP_RISE}}$ | | | | | |
| Full Speed Mode | | | | 150 | ns | $R_{\text{SLOPE}} = 0\ \Omega$, $t_{\text{BIT_TXD}} = 200\text{ ns}$ |
| Slope Control Mode | | | | 300 | ns | $R_{\text{SLOPE}} = 47\text{ k}\Omega$, $t_{\text{BIT_TXD}} = 1\ \mu\text{s}$ |
| Loop Delay Symmetry (Minimum Recessive Bit Width) | $t_{\text{BIT_RXD}}$ | | | | | |
| 2 Mbps | | 450 | | 550 | ns | $t_{\text{BIT_TXD}} = 500\text{ ns}$ |
| 5 Mbps | | 160 | | 220 | ns | $t_{\text{BIT_TXD}} = 200\text{ ns}$ |
| 8 Mbps | | 85 | | 140 | ns | $t_{\text{BIT_TXD}} = 125\text{ ns}$ |
| 12 Mbps | | 50 | | 91.6 | ns | $t_{\text{BIT_TXD}} = 83.3\text{ ns}$ |
| CANH, CANL SLEW RATE | SR | | 7 | | V/ μs | SILENT low, see Figure 29, $R_L = 60\ \Omega$, $C_L = 100\text{ pF}$, $R_{\text{SLOPE}} = 47\text{ k}\Omega$ |
| STANDBY MODE | | | | | | |
| Minimum Pulse Width Detected (Receiver Filter Time) | t_{FILTER} | 1 | | 5 | μs | STBY high, see Figure 4 |
| Wake-Up Pattern Detection Reset Time | t_{WUPR} | 1175 | | 4000 | μs | STBY high, see Figure 4 |
| Normal Mode to Standby Mode Time | $t_{\text{STBY_ON}}$ | | | 25 | μs | |
| Standby Mode to Normal Mode Time | $t_{\text{STBY_OFF}}$ | | | 25 | μs | Time until RXD valid |
| AUXILIARY SIGNAL | | | | | | |
| Maximum Switching Rate | f_{AUX} | 20 | | | kHz | |
| AUX _{IN} to AUX _{OUT} Propagation Delay | t_{AUX} | | | 25 | μs | |
| SILENT MODE | | | | | | |
| Normal Mode to Silent Mode Time | $t_{\text{SILENT_ON}}$ | | 40 | 100 | ns | TXD low, $R_{\text{SLOPE}} = 0\ \Omega$, see Figure 3 |
| Silent Mode to Normal Mode Time | $t_{\text{SILENT_OFF}}$ | | 50 | 100 | ns | TXD low, $R_{\text{SLOPE}} = 0\ \Omega$, see Figure 3 |

Timing Diagrams

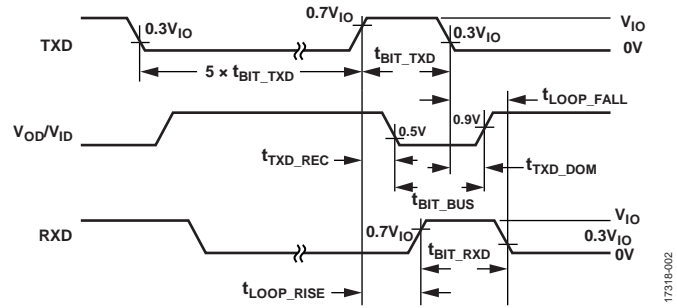

Figure 2. Transceiver Timing Diagram

17318-002

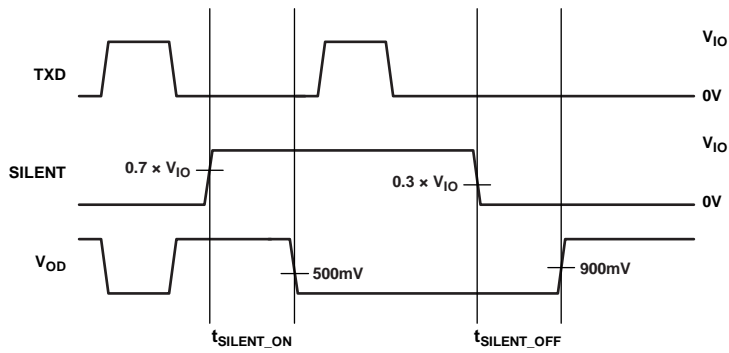

Figure 3. Silent Mode Timing Diagram

17318-015

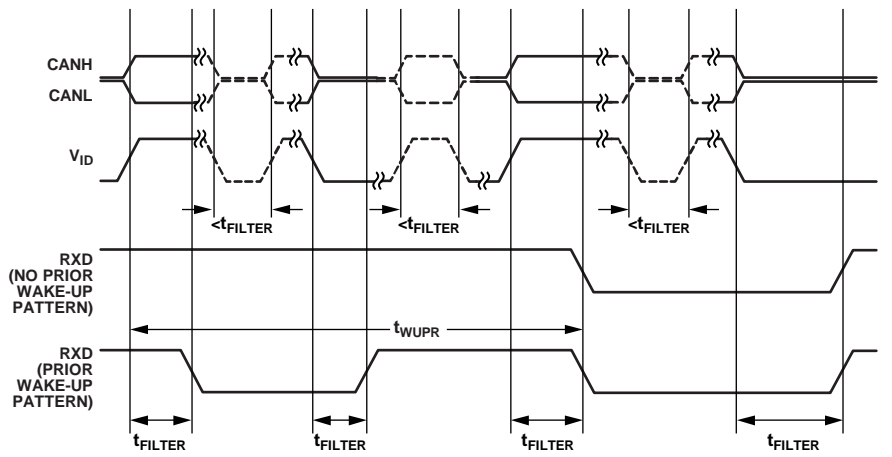

Figure 4. Wake-Up Pattern Detection and Filtered RXD in Standby Mode Timing Diagram

17318-004

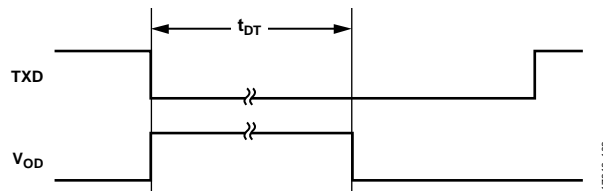

Figure 5. Dominant Timeout

17318-103

INSULATION AND SAFETY RELATED SPECIFICATIONS

For additional information, see www.analog.com/icouplersafety.

Table 3.

| Parameter | Symbol | Value | Unit | Test Conditions/Comments |
|---|---------|-------|--------|--|
| Rated Dielectric Insulation Voltage | | 3000 | V rms | 1-minute duration |
| Minimum External Air Gap (Clearance) | L (I01) | 7.8 | mm min | Measured from input terminals to output terminals, shortest distance through air |
| Minimum External Tracking (Creepage) | L (I02) | 7.8 | mm min | Measured from input terminals to output terminals, shortest distance path along body |
| Minimum Clearance in the Plane of the Printed Circuit Board (PCB Clearance) | L (PCB) | 7.8 | mm min | Measured from input terminals to output terminals, shortest distance through air, line of sight, in the PCB mounting plane |
| Minimum Internal Gap (Internal Clearance) | | 21 | µm min | Insulation distance through insulation |
| Tracking Resistance (Comparative Tracking Index) | CTI | >600 | V | IEC 60112 |
| Material Group | | I | | Material Group (IEC 60664-1) |

PACKAGE CHARACTERISTICS

Table 4.

| Parameter | Symbol | Min | Typ | Max | Unit | Test Conditions/Comments |
|--|------------------|-----|------------------|-----|------|--------------------------|
| Resistance (Input to Output) ¹ | R _{I-O} | | 10 ¹³ | | Ω | |
| Capacitance (Input to Output) ¹ | C _{I-O} | | 3.7 | | pF | f = 1 MHz |
| Input Capacitance ² | C _I | | 4.0 | | pF | |

¹ The device is considered a 2-terminal device: Pin 1 through Pin 10 are shorted together, and Pin 11 through Pin 20 are shorted together.

² Input capacitance is from any input data pin to ground.

REGULATORY INFORMATION

See Table 9 for details regarding maximum working voltages for specific cross isolation waveforms and insulation levels. The ADM3057E-EP is approved or pending approval by the organizations listed in Table 5.

Table 5.

| UL (Pending)¹ | CSA (Pending) | VDE (Pending)² | CQC (Pending) |
|---|---|---|--|
| Recognized Under UL 1577 Component Recognition Program Single Protection, 3000 V rms Isolation Voltage File E214100 | Approved under CSA Component Acceptance Notice 5A CSA 60950-1-07+A1+A2 and IEC 60950-1, second edition, +A1+A2 Basic insulation at 780 V rms (1103 V_{PEAK}) Reinforced insulation at 390 V rms (552 V_{PEAK}) IEC 60601-1 Edition 3.1: Basic insulation (1 MOPP), 490 V rms (693 V_{PEAK}) Reinforced insulation (2 MOPP), 250 V rms (353 V_{PEAK}) CSA 61010-1-12 and IEC 61010-1 third edition Basic insulation at 300 V rms mains, 780 V secondary (1103 V_{PEAK}) Reinforced insulation at 300 V rms mains, 390 V secondary (552 V_{PEAK}) File 205078 | DIN V VDE V 0884-10 (VDE V 0884-10):2006-12 Reinforced insulation 849 V_{PEAK} , surge isolation voltage (V_{IOTM}) = 6000 V_{PEAK} File 2471900-4880-0001 | Certified under CQC11-471543-2012 GB4943.1-2011: basic insulation at 780 V rms (1103 V_{PEAK}) Reinforced insulation at 390 V rms (552 V_{PEAK}) File (pending) |

¹ In accordance with UL 1577, each ADM3057E-EP is proof tested by applying an insulation test voltage ≥ 3600 V rms for 1 sec.

² In accordance with DIN V VDE V 0884-10, each ADM3057E-EP is proof tested by applying an insulation test voltage $\geq 1592 V_{PEAK}$ for 1 sec (partial discharge detection limit = 5 pC). The * marking branded on the component designates DIN V VDE V 0884-10 approval.

DIN V VDE V 0884-10 (VDE V 0884-10) INSULATION CHARACTERISTICS

These isolators are suitable for reinforced electrical isolation only within the safety limit data. The protective circuits ensure the maintenance of the safety data. The asterisk (*) marking on packages denotes DIN V VDE V 0884-10 approval.

Table 6. VDE Characteristics

| Description | Test Conditions/Comments | Symbol | Characteristic | Unit |
|---|--|-------------|--------------------------------|------------|
| Installation Classification per DIN VDE 0110 For Rated Mains Voltage ≤ 150 V rms For Rated Mains Voltage ≤ 300 V rms For Rated Mains Voltage ≤ 400 V rms | | | I to IV I to IV I to III | |
| Climatic Classification | | | 55/105/21 | |
| Pollution Degree per DIN VDE 0110, Table 1 | | | 2 | |
| Maximum Working Insulation Voltage | | V_{IORM} | 849 | V_{PEAK} |
| Input to Output Test Voltage, Method B1 | $V_{IORM} \times 1.875 = V_{PR}$, 100% production test, $t_m = 1$ sec, partial discharge < 5 pC | $V_{pd(m)}$ | 1592 | V_{PEAK} |
| Input to Output Test Voltage, Method A After Environmental Tests Subgroup 1 | $V_{IORM} \times 1.5 = V_{pd(m)}$, $t_{ini} = 60$ sec, $t_m = 10$ sec, partial discharge < 5 pC | $V_{pd(m)}$ | 1273 | V_{PEAK} |
| After Input or Safety Test Subgroup 2 and Subgroup 3 | $V_{IORM} \times 1.2 = V_{pd(m)}$, $t_{ini} = 60$ sec, $t_m = 10$ sec, partial discharge < 5 pC | $V_{pd(m)}$ | 1018 | V_{PEAK} |
| Highest Allowable Overvoltage | Transient overvoltage, $t_{TR} = 10$ sec | V_{IOTM} | 6000 | V_{PEAK} |
| Surge Isolation Voltage Reinforced | $V_{IOSM(TEST)} = 10$ kV, 1.2 μs rise time, 50 μs, 50% fall time | V_{IOSM} | 6000 | V_{PEAK} |
| Safety Limiting Values | Maximum value allowed in the event of a failure (see Figure 6) | | | |
| Case Temperature | | T_S | 150 | °C |
| Total Power Dissipation at 25°C | | P_S | 2.35 | W |
| Insulation Resistance at T_S | $V_{IO} = 500$ V | R_S | >10 ⁹ | Ω |

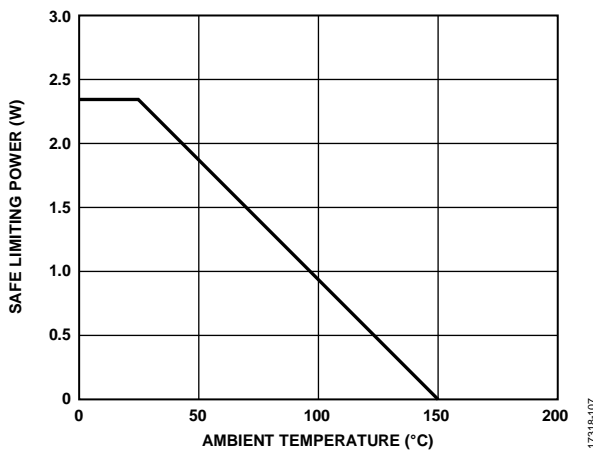

Figure 6. Thermal Derating Curve, Dependence of Safety Limiting Values with Ambient Temperature per DIN V VDE V 0884-10

ABSOLUTE MAXIMUM RATINGS

Pin voltages with respect to GND_x are on the same side, unless otherwise noted.

Table 7.

| Parameter | Rating |
|---|--|
| V _{CC} | –0.5 V to +6 V |
| V _{IO} | –0.5 V to +6 V |
| Logic Side Input/Output: TXD, RXD, AUX _{IN} , SILENT, STBY | –0.5 V to V _{IO} + 0.5 V |
| CANH, CANL | –40 V to +40 V |
| AUX _{OUT} , RS | –0.5 V to V _{ISOIN} + 0.5 V |
| Operating Temperature Range | –55°C to +105°C |
| Storage Temperature Range | –65°C to +150°C |
| Junction Temperature (T _J Maximum) | 150°C |
| Power Dissipation | (T _J maximum – T _A)/θ _{JA} |
| Electrostatic Discharge (ESD) | |
| IEC 61000-4-2, CANH/CANL | |
| Across Isolation Barrier to GND ₁ | ±8 kV |
| Contact Discharge to GND ₂ | ±8 kV |
| Air Discharge to GND ₂ | ±15 kV |
| Human Body Model (HBM), All Pins, 1.5 kΩ, 100 pF | 4 kV |
| Moisture Sensitivity Level (MSL) | MSL3 |

Stresses at or above those listed under Absolute Maximum Ratings may cause permanent damage to the product. This is a stress rating only; functional operation of the product at these or any other conditions above those indicated in the operational section of this specification is not implied. Operation beyond the maximum operating conditions for extended periods may affect product reliability.

Table 9. Maximum Continuous Working Voltage¹

| Parameter | Rating | Unit | Constraint |
|-----------------------|--------|-------------------|---|
| AC Voltage | | | |
| Bipolar Waveform | | | |
| Basic Insulation | 566 | V _{PEAK} | Lifetime limited by insulation lifetime per VDE-0884-11 |
| Reinforced Insulation | 467 | V _{PEAK} | Lifetime limited by insulation lifetime per VDE-0884-11 |
| Unipolar Waveform | | | |
| Basic Insulation | 1131 | V _{PEAK} | Lifetime limited by insulation lifetime per VDE-0884-11 |
| Reinforced Insulation | 933 | V _{PEAK} | Lifetime limited by insulation lifetime per VDE-0884-11 |
| DC Voltage | | | |
| Basic Insulation | 1560 | V _{PEAK} | Lifetime limited by package creepage per IEC 60664-1 |
| Reinforced Insulation | 780 | V _{PEAK} | Lifetime limited by package creepage per IEC 60664-1 |

¹ Maximum continuous working voltage refers to the continuous voltage magnitude imposed across the isolation barrier. See the ADM3057E data sheet for more details.

THERMAL RESISTANCE

Thermal performance is directly linked to PCB design and operating environment. Careful attention to PCB thermal design is required.

The thermal resistance value specified in Table 8 is simulated based on JEDEC specifications (unless specified otherwise) and must be used in compliance with JESD51-12.

Table 8. Thermal Resistance

| Package Type | θ _{JA} | Unit |
|--------------------|-----------------|------|
| RW-20 ¹ | 53 | °C/W |

¹ The θ_{JA} value is based on simulations of a device mounted on a JEDEC standard, 4-layer board with fine width traces and still air. See the ADM3057E data sheet for thermal model definitions.

ESD CAUTION



ESD (electrostatic discharge) sensitive device. Charged devices and circuit boards can discharge without detection. Although this product features patented or proprietary protection circuitry, damage may occur on devices subjected to high energy ESD. Therefore, proper ESD precautions should be taken to avoid performance degradation or loss of functionality.

PIN CONFIGURATION AND FUNCTION DESCRIPTIONS

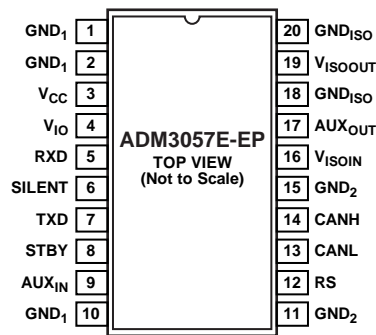

Figure 7. Pin Configuration

Table 10. Pin Function Descriptions

| Pin No. | Mnemonic | Description |
|----------|---------------------|--|
| 1, 2, 10 | GND ₁ | Ground, Logic Side. |
| 3 | V _{CC} | <i>iso</i> Power Power Supply, 4.5 V to 5.5 V. This pin requires 0.1 μ F and 10 μ F decoupling capacitors. |
| 4 | V _{IO} | <i>i</i> Coupler Power Supply, 1.7 V to 5.5 V. This pin requires 0.01 μ F and 0.1 μ F decoupling capacitors. |
| 5 | RXD | Receiver Output Data. |
| 6 | SILENT | Silent Mode Select with Input High. Bring this input low or leave the pin unconnected (internal pull-down) for normal mode. |
| 7 | TXD | Driver Input Data. This pin has a weak internal pull-up resistor to V _{IO} . |
| 8 | STBY | Standby Mode Select with Input High. Bring this input low or leave the pin unconnected (internal pull-down) for normal mode. |
| 9 | AUX _{IN} | Auxiliary Channel Input. This pin sets the AUX _{OUT} output. |
| 11, 15 | GND ₂ | Ground, Bus Side. |
| 12 | RS | Slope Control Pin. Short this pin to ground for full speed operation or use a weak pull-down resistor (for example, 47 k Ω) for slope control mode. An input high signal places the CAN transceiver in standby mode. |
| 13 | CANL | CAN Low Input/Output. |
| 14 | CANH | CAN High Input/Output. |
| 16 | V _{ISOIN} | Isolated Power Supply Input for the CAN Transceiver Bus Side Digital Isolator. This pin requires 0.01 μ F and 0.1 μ F decoupling capacitors. |
| 17 | AUX _{OUT} | Isolated Auxiliary Channel Output. The state of AUX _{OUT} is latched when STBY is high. By default, AUX _{OUT} is low at startup or when V _{IO} is unpowered. |
| 18, 20 | GND _{ISO} | Ground for the Isolated DC-to-DC Converter. Connect these pins together through one ferrite bead to PCB ground (bus side). |
| 19 | V _{ISOOUT} | Isolated Power Supply Output. This pin requires 0.22 μ F and 10 μ F capacitors to GND _{ISO} . Connect this pin through a ferrite bead and short the PCB trace to V _{ISOIN} for operation. |

OPERATIONAL TRUTH TABLE

Table 11. Truth Table

| Power | | Inputs ^{1,2} | | | | | Mode | Outputs ² | | Input/Output |
|-----------------|-----------------|-----------------------|--------|------|-------------------|-------------------|-----------------------|----------------------|--------------------|--------------------------------------|
| V _{CC} | V _{IO} | TXD | SILENT | STBY | AUX _{IN} | RS | | RXD ³ | AUX _{OUT} | CANH/CANL |
| On | On | Low | Low | Low | Low | Low/ pull-down | Normal/ slope mode | Low | Low | Dominant ⁴ |
| On | On | Low | Low | Low | High | Low/ pull-down | Normal/ slope mode | Low | High | Dominant ⁴ |
| On | On | High | Low | Low | Low | Low/ pull-down | Normal/ slope mode | High/per bus | Low | Recessive/set by bus |
| On | On | High | Low | Low | High | Low/ pull-down | Normal/ slope mode | High/per bus | High | Recessive/set by bus |
| On | On | X | High | Low | Low | X | Listen only | High/per bus | Low | Recessive/set by bus |
| On | On | X | High | Low | High | X | Listen only | High/per bus | High | Recessive/set by bus |
| On | On | X | X | High | X | X | Standby | High/WUP/filtered | Last state | Bias to GND ₂ /set by bus |
| On | On | X | X | X | Low | Pull-up | Standby ⁵ | High/WUP/filtered | Low | Bias to GND ₂ /set by bus |
| On | On | X | X | X | High | Pull-up | Standby ⁵ | High/WUP/filtered | High | Bias to GND ₂ /set by bus |
| On | Off | Z | Z | Z | Z | Low/ pull-down | Normal/ slope mode | Z | Low | Recessive/set by bus |
| Off | On | X | X | X | X | X | Transceiver off | High | Z | High impedance/set by bus |
| Off | Off | Z | Z | Z | Z | Z | Transceiver off | Z | Z | High impedance/set by bus |

¹ X means irrelevant.

² Z means high impedance within one diode drop of ground.

³ WUP means remote wake-up pattern.

⁴ Limited by t_{DR}.

⁵ RS can only set the transceiver to standby mode. RS does not control the digital isolator.

TYPICAL PERFORMANCE CHARACTERISTICS

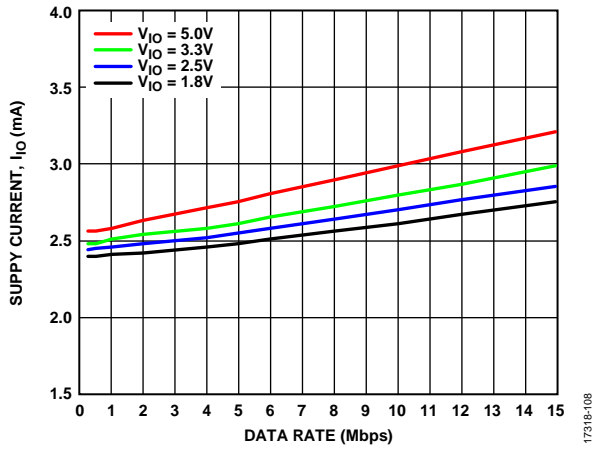

Figure 8. Supply Current, I_{IO} vs. Data Rate

17318-108

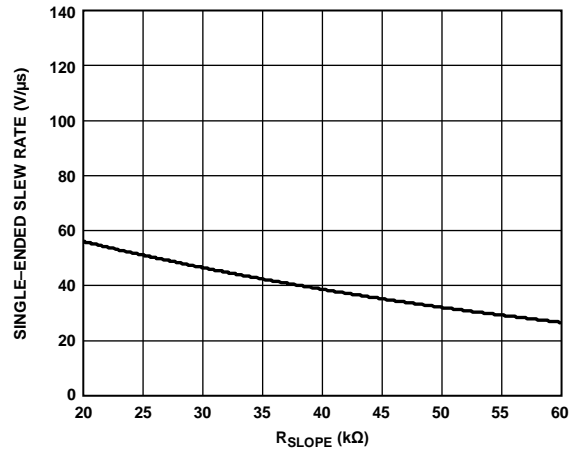

Figure 11. Single-Ended Slew Rate vs. R_{SLOPE}

17318-111

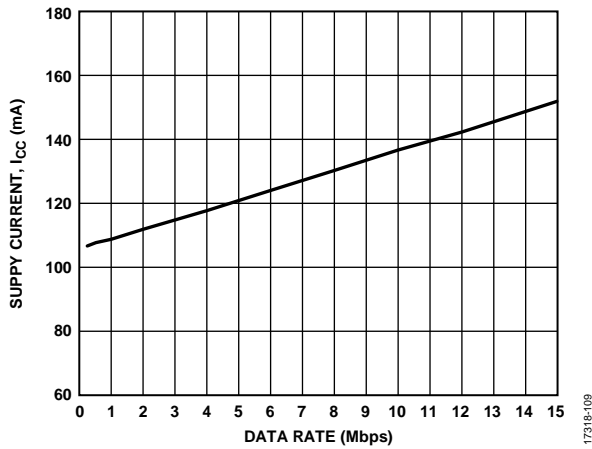

Figure 9. Supply Current, I_{CC} vs. Data Rate

17318-109

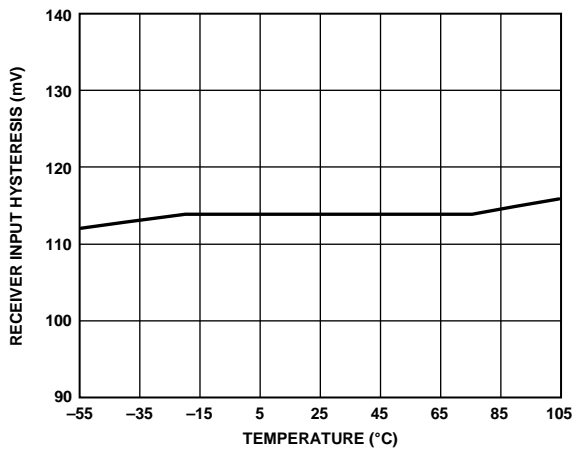

Figure 12. Receiver Input Hysteresis vs. Temperature

17318-112

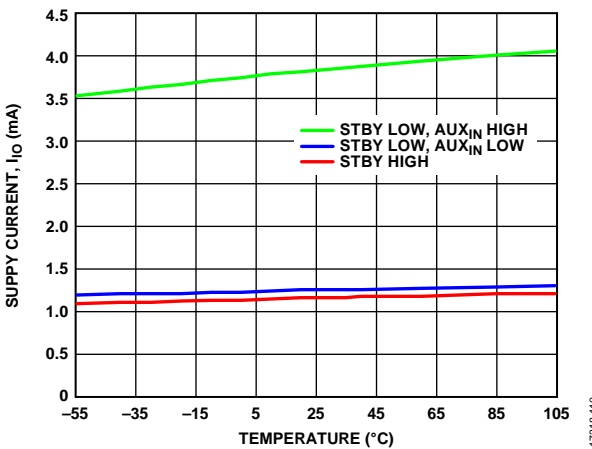

Figure 10. Supply Current, I_{IO} vs. Temperature (Inputs Idle)

17318-110

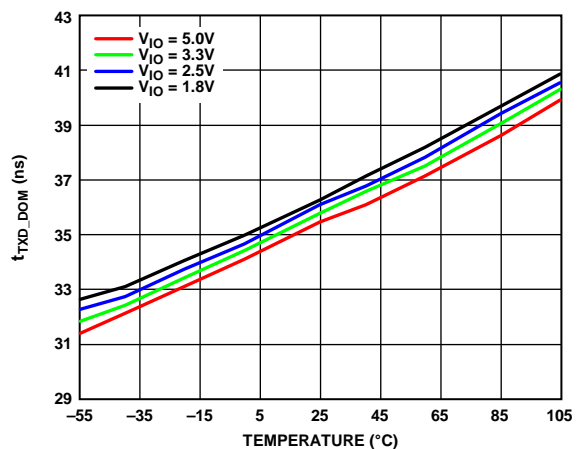

Figure 13. t_{TXD_DOM} vs. Temperature

17318-113

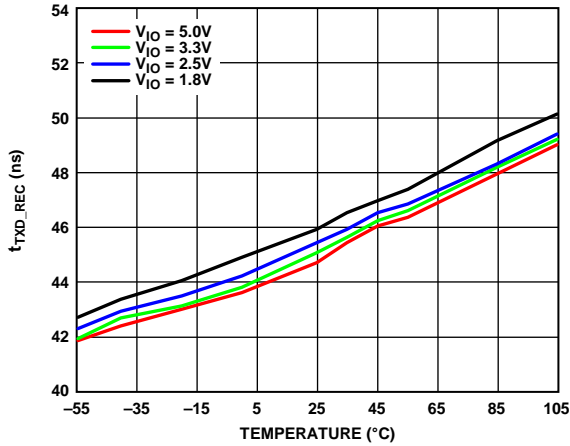

Figure 14. t_{TXD_REC} vs. Temperature

17318-114

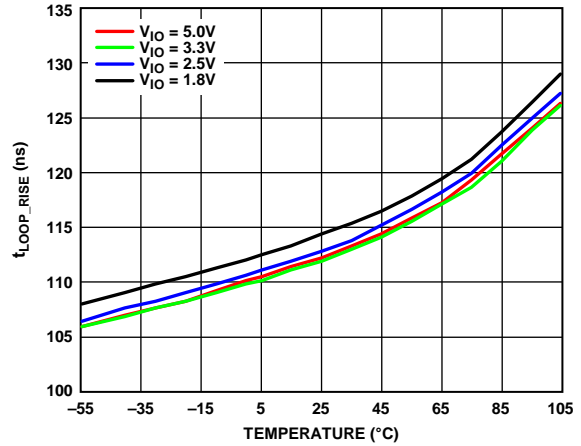

Figure 17. t_{LOOP_RISE} vs. Temperature ($R_{SLOPE} = 0 \Omega$)

17318-117

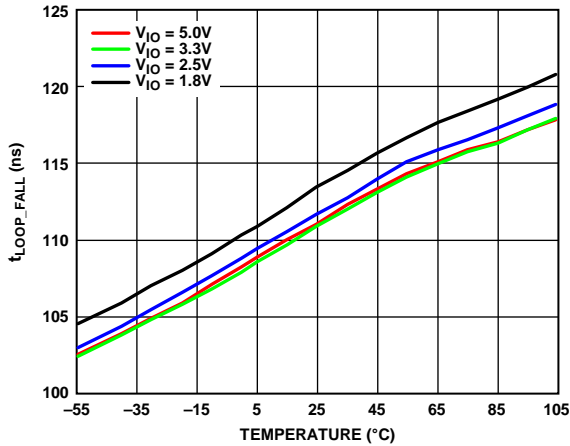

Figure 15. t_{LOOP_FALL} vs. Temperature ($R_{SLOPE} = 0 \Omega$)

17318-115

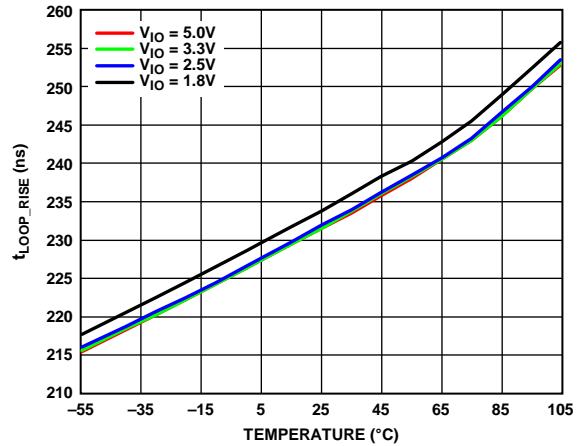

Figure 18. t_{LOOP_RISE} vs. Temperature ($R_{SLOPE} = 47 k\Omega$)

17318-118

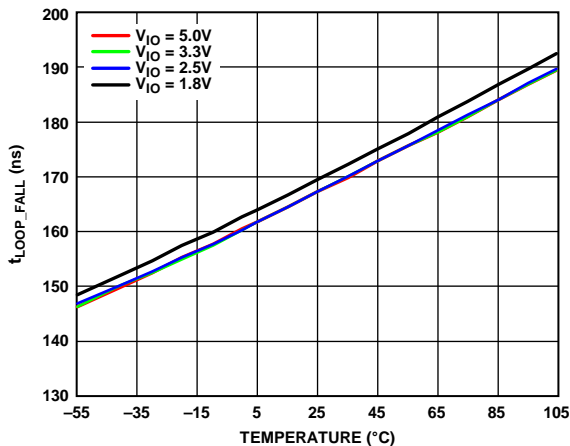

Figure 16. t_{LOOP_FALL} vs. Temperature ($R_{SLOPE} = 47 k\Omega$)

17318-116

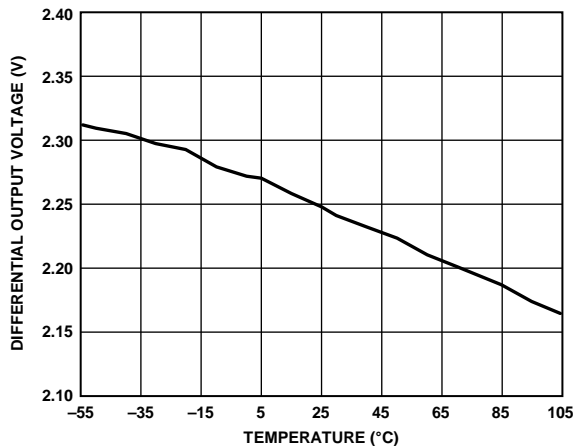

Figure 19. Differential Output Voltage (V_{OD}) vs. Temperature

17318-119

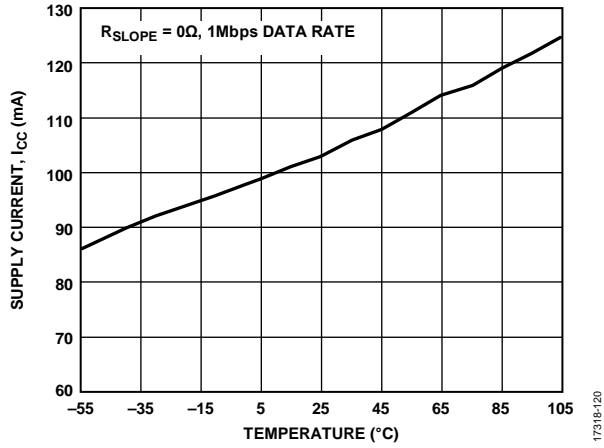

Figure 20. Supply Current, I_{CC} vs. Temperature

17318-120

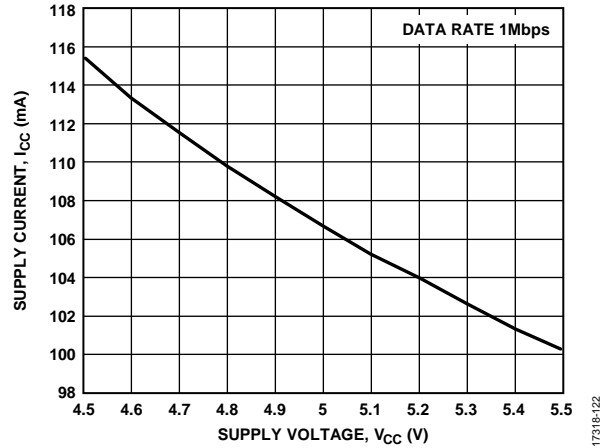

Figure 22. Supply Current, I_{CC} vs. Supply Voltage, V_{CC} , $R_S = 0\ \Omega$, 1 Mbps

17318-122

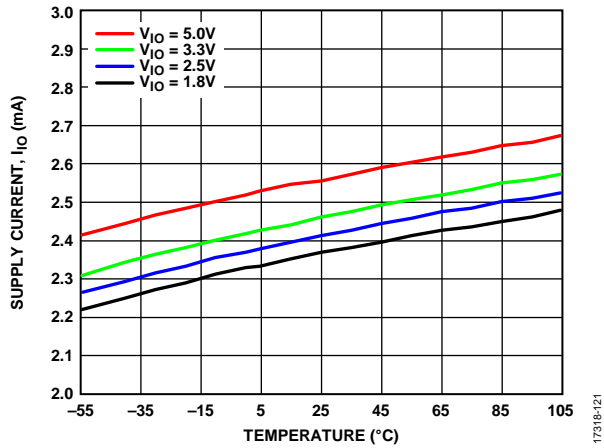

Figure 21. Supply Current, I_{IO} vs. Temperature, $R_S = 0\ \Omega$, 1 Mbps

17318-121

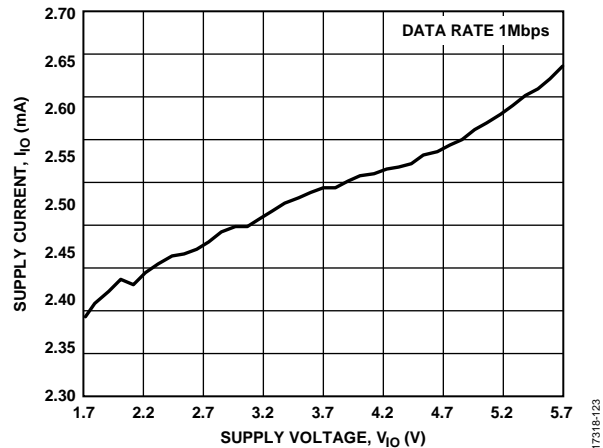

Figure 23. Supply Current, I_{IO} vs. Supply Voltage, V_{IO} , Data Rate = 1 Mbps

17318-123

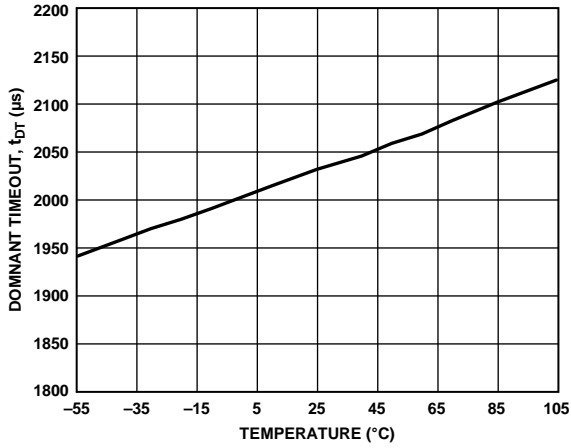

Figure 24. Dominant Timeout, t_{DT} vs. Temperature

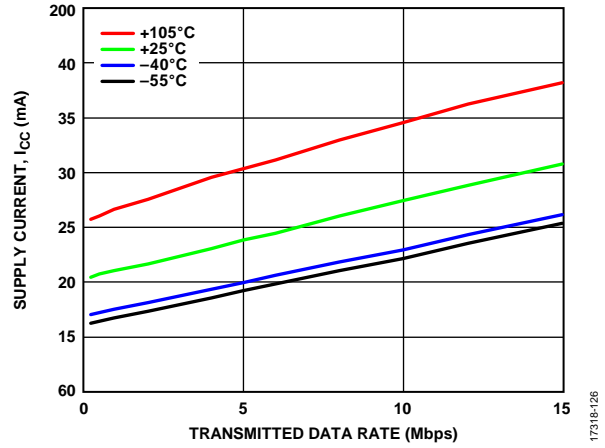

Figure 26. Supply Current, I_{CC} vs. Transmitted Data Rate

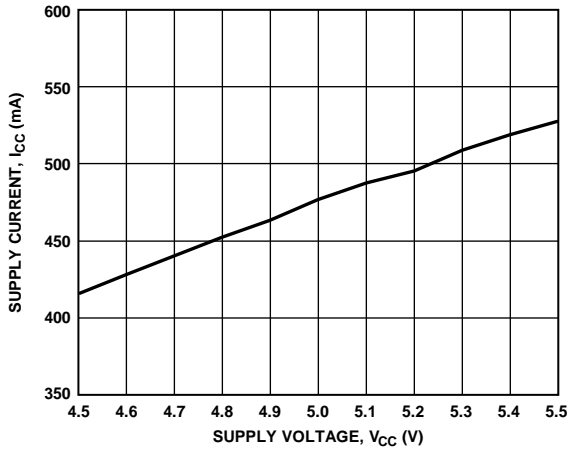

Figure 25. Supply Current, I_{CC} vs. Supply Voltage, V_{CC}
(V_{ISOOUT} Shorted to GND_{ISO})

17318-124

17318-126

17318-125

TEST CIRCUITS

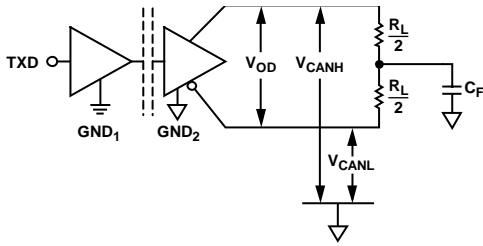

Figure 27. Driver Voltage Measurement

17318-008

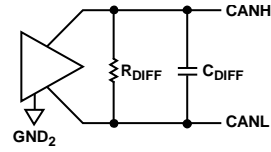

Figure 30. R_{DIFF} and C_{DIFF} Measured in Recessive State, Bus Disconnected

17318-011

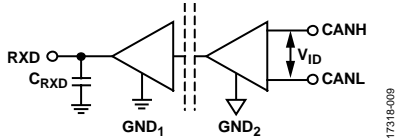

Figure 28. Receiver Voltage Measurement

17318-009

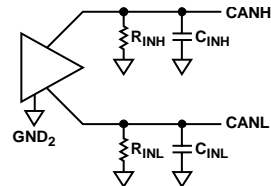
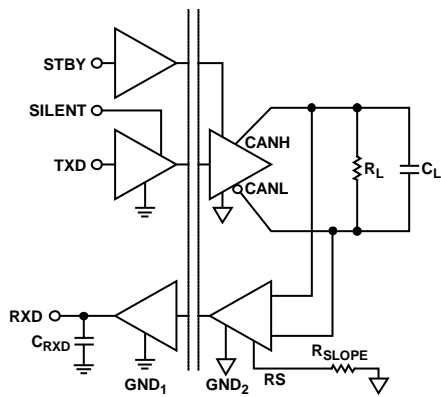

Figure 31. R_{INx} and C_{INx} Measured in Recessive State, Bus Disconnected

17318-012



NOTES
1. 1% TOLERANCE FOR ALL RESISTORS AND CAPACITORS.

Figure 29. Switching Characteristics Measurements

17318-010

OUTLINE DIMENSIONS

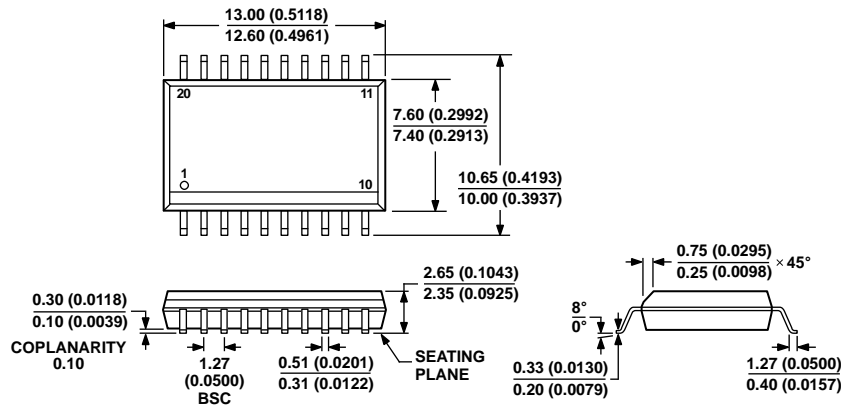

COMPLIANT TO JEDEC STANDARDS MS-013-AC
 CONTROLLING DIMENSIONS ARE IN MILLIMETERS; INCH DIMENSIONS
 (IN PARENTHESES) ARE ROUNDED-OFF MILLIMETER EQUIVALENTS FOR
 REFERENCE ONLY AND ARE NOT APPROPRIATE FOR USE IN DESIGN.

Figure 32. 20-Lead Standard Small Outline Package [SOIC_W]
 Wide Body
 (RW-20)

Dimensions shown in millimeters and (inches)

06-07-2006-A

ORDERING GUIDE

| Model ^{1,2} | Temperature Range | Package Description | Package Option |
|----------------------|-------------------|---|----------------|
| ADM3057ETRWZ-EP | -55°C to +105°C | 20-Lead Standard Small Outline Package [SOIC_W] | RW-20 |
| ADM3057ETRWZ-EP-RL | -55°C to +105°C | 20-Lead Standard Small Outline Package [SOIC_W] | RW-20 |
| EVAL-ADM3055EEBZ | | ADM3055E Evaluation Board | |

¹ Z = RoHS Compliant Part.

² Use the [EVAL-ADM3055EEBZ](#) evaluation board to evaluate the ADM3057E-EP.