



Typical Applications

This switch is suitable for usage in DC - 8.0 GHz 50-Ohm or 75-Ohm systems:

- Broadband
- Fiber Optics
- Switched Filter Banks
- Wireless below 8 GHz

Features

- Broadband Performance: DC - 8 GHz
- High Isolation: 40 dB@ 6 GHz
- Low Insertion Loss: 1.8 dB@ 6 GHz
- Integrated 2:4 TTL Decoder
- 16 Lead 3x3mm QFN Package: 9 mm²

Functional Diagram

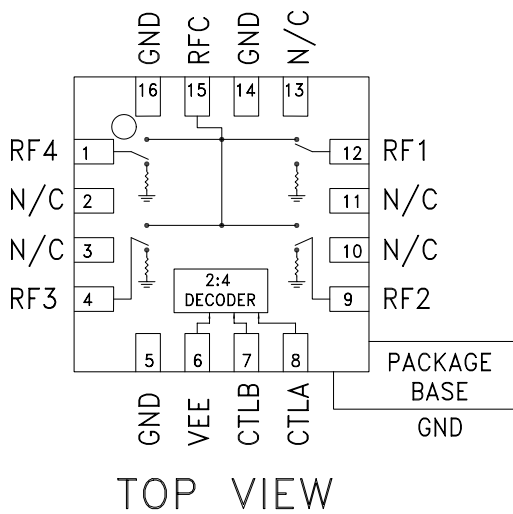

General Description

The HMC344LP3 & HMC344LP3E are broadband non-reflective GaAs MESFET SP4T switches in low cost leadless surface mount packages. Covering DC to 8 GHz, this switch offers high isolation and low insertion loss and extends the frequency coverage of Hittite's SP4T switch product line. This switch also includes an on board binary decoder circuit which reduces the required logic control lines to two. The switch operates using a negative control voltage of 0/-5V, and requires a fixed bias of -5V.

Electrical Specifications, $T_A = +25^\circ C$, With 0/-5V Control, 50 Ohm System

| Parameter | Frequency | Min. | Typ. | Max. | Units | |
|--|---------------|----------------------------------|------|------|-------|----|
| Insertion Loss | DC - 2.0 GHz | | 1.6 | 2.0 | dB | |
| | DC - 6.0 GHz | | 1.8 | 2.2 | dB | |
| | DC - 8.0 GHz | | 2.1 | 2.5 | dB | |
| Isolation | DC - 2.0 GHz | 43 | 48 | | dB | |
| | DC - 4.0 GHz | 36 | 41 | | dB | |
| | DC - 6.0 GHz | 34 | 40 | | dB | |
| | DC - 8.0 GHz | 31 | 36 | | dB | |
| Return Loss | "On State" | DC - 2.0 GHz | 12 | 15 | | dB |
| | | DC - 4.0 GHz | 9 | 12 | | dB |
| | | DC - 6.0 GHz | 8 | 11 | | dB |
| | | DC - 8.0 GHz | 5 | 8 | | dB |
| Return Loss | "Off State" | DC - 8.0 GHz | 7 | 10 | | dB |
| Input Power for 1 dB Compression | 0.5 - 8.0 GHz | 17 | 21 | | dBm | |
| Input Third Order Intercept (Two-Tone Input Power = +7 dBm Each Tone) | 0.5 - 8.0 GHz | 37 | 40 | | dBm | |
| Switching Characteristics | DC - 8.0 GHz | tRISE, tFALL (10/90% RF) | | 35 | | ns |
| | | tON, tOFF (50% CTL to 10/90% RF) | | 150 | | ns |

Information furnished by Analog Devices is believed to be accurate and reliable. However, no responsibility is assumed by Analog Devices for its use, nor for any infringements of patents or other rights of third parties that may result from its use. Specifications subject to change without notice. No license is granted by implication or otherwise under any patent or patent rights of Analog Devices. Trademarks and registered trademarks are the property of their respective owners.

For price, delivery, and to place orders: Analog Devices, Inc., One Technology Way, P.O. Box 9106, Norwood, MA 02062-9106
Phone: 781-329-4700 • Order online at www.analog.com
Application Support: Phone: 1-800-ANALOG-D



GaAs MMIC SP4T NON-REFLECTIVE SWITCH, DC - 8 GHz

Insertion Loss vs. Temperature

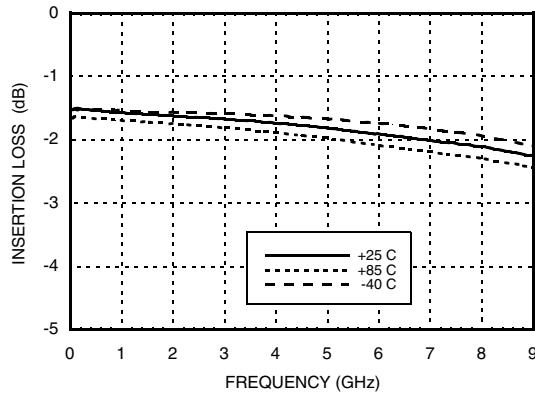

Isolation

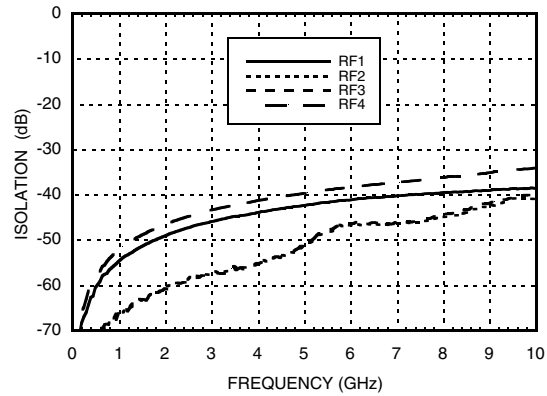

Return Loss

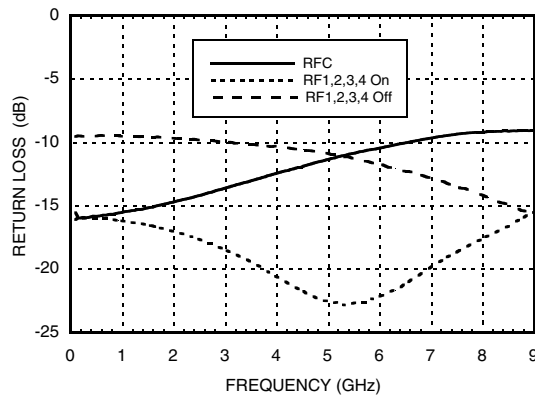

0.1 and 1 dB Input Compression Point

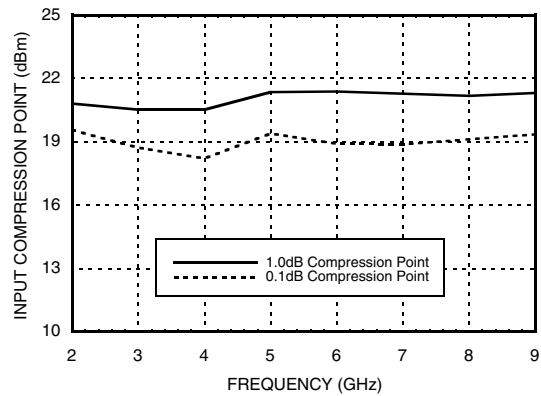

Input Third Order Intercept Point

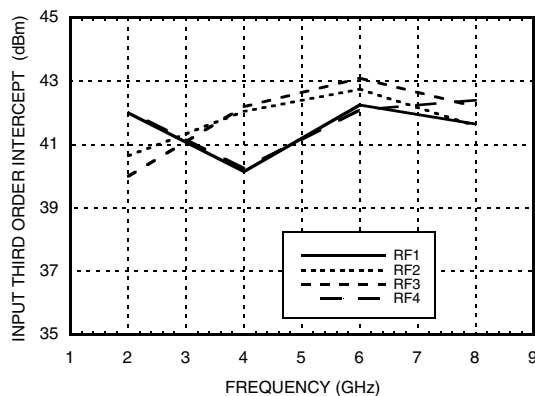

Bias Voltage & Current

| Vee Range = -5.0 Vdc ± 10% | | |
|----------------------------|-----------------------------|-----------------------------|
| Vee (Vdc) | I _{ee} (Typ.) (mA) | I _{ee} (Max.) (mA) |
| -5.0 | 3.0 | 6.0 |

Control Voltages

| State | Bias Condition |
|-------|-------------------------------|
| Low | -3V to 0 Vdc @ 60 μA Typical |
| High | -5 to -4.2 Vdc @ 5 μA Typical |

* Isolation is recorded above insertion loss & measured at output of switch.

Information furnished by Analog Devices is believed to be accurate and reliable. However, no responsibility is assumed by Analog Devices for its use, nor for any infringements of patents or other rights of third parties that may result from its use. Specifications subject to change without notice. No license is granted by implication or otherwise under any patent or patent rights of Analog Devices. Trademarks and registered trademarks are the property of their respective owners.

For price, delivery, and to place orders: Analog Devices, Inc., One Technology Way, P.O. Box 9106, Norwood, MA 02062-9106 Phone: 781-329-4700 • Order online at www.analog.com Application Support: Phone: 1-800-ANALOG-D

GaAs MMIC SP4T NON-REFLECTIVE SWITCH, DC - 8 GHz



Absolute Maximum Ratings

| | |
|--|-----------------------|
| Bias Voltage Range (Vee) | -7.0 Vdc |
| Control Voltage Range (A & B) | Vee -0.5V to +1.0 Vdc |
| Channel Temperature | 150 °C |
| Thermal Resistance (Insertion Loss Path) | 143 °C/W |
| Thermal Resistance (Terminated Path) | 1,030 °C/W |
| Storage Temperature | -65 to +150 °C |
| Operating Temperature | -40 to +85 °C |
| Maximum Input Power | +24 dBm |
| ESD Sensitivity (HBM) | Class 1A |

Truth Table

| Control Input | | Signal Path State |
|---------------|------|-------------------|
| A | B | RFCOM to: |
| High | High | RF1 |
| Low | High | RF2 |
| High | Low | RF3 |
| Low | Low | RF4 |



**ELECTROSTATIC SENSITIVE DEVICE
OBSERVE HANDLING PRECAUTIONS**

Outline Drawing

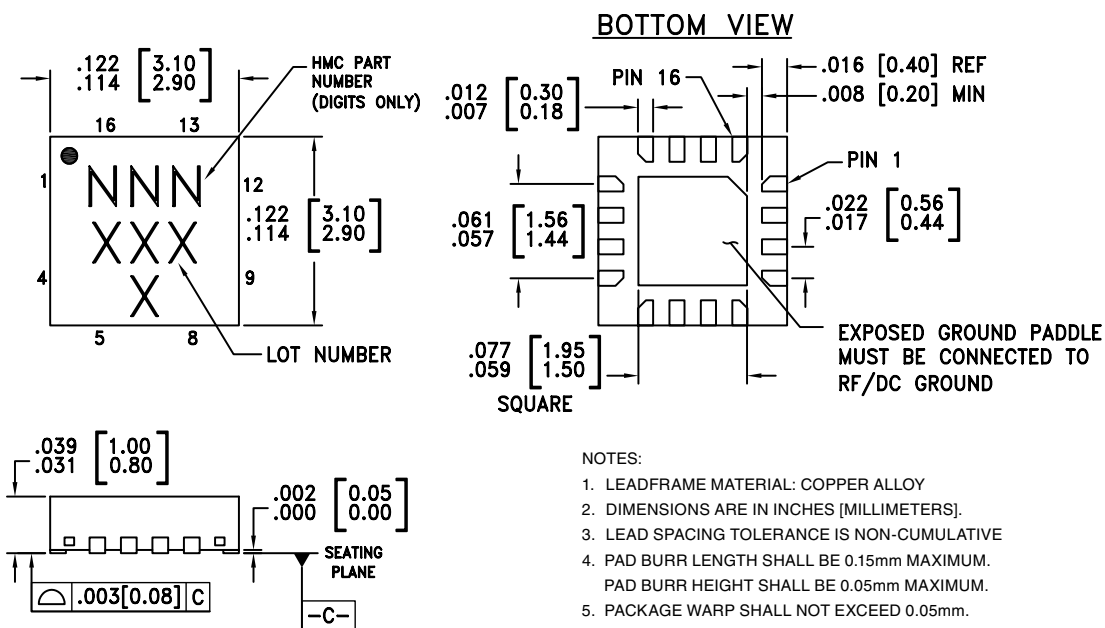

NOTES:

- LEADFRAME MATERIAL: COPPER ALLOY
- DIMENSIONS ARE IN INCHES [MILLIMETERS].
- LEAD SPACING TOLERANCE IS NON-CUMULATIVE
- PAD BURR LENGTH SHALL BE 0.15mm MAXIMUM.
PAD BURR HEIGHT SHALL BE 0.05mm MAXIMUM.
- PACKAGE WARP SHALL NOT EXCEED 0.05mm.
- ALL GROUND LEADS AND GROUND PADDLE MUST BE SOLDERED TO PCB RF GROUND.
- REFER TO HITTITE APPLICATION NOTE FOR SUGGESTED PCB LAND PATTERN.

Package Information

| Part Number | Package Body Material | Lead Finish | MSL Rating | Package Marking ^[3] |
|-------------|---|---------------|---------------------|--------------------------------|
| HMC344LP3 | Low Stress Injection Molding Plastic | Sn/Pb Solder | MSL1 ^[1] | 344 XXXX |
| HMC344LP3E | RoHS-compliant Low Stress Injection Molding Plastic | 100% matte Sn | MSL1 ^[2] | 344 XXXX |

[1] Max peak reflow temperature of 235 °C



[2] Max peak reflow temperature of 260 °C

[3] 4-Digit lot number XXXX

GaAs MMIC SP4T NON-REFLECTIVE SWITCH, DC - 8 GHz

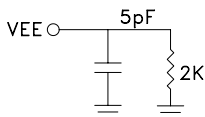
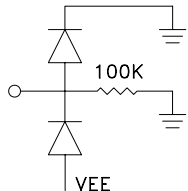

Pin Descriptions

| Pin Number | Function | Description | Interface Schematic |
|---------------------|----------------------------|---|--|
| 1, 4, 9, 12, 15 | RF4, RF3, RF2, RF1, RFC | This pin is DC coupled and matched to 50 Ohm. Blocking capacitors are required if RF line potential is not equal to 0V. | |
| 2, 3, 10, 11, 13 | N/C | This pin should be connected to PCB RF ground to maximize isolation. |  |
| 5, 14, 16 | GND | Package bottom has exposed metal paddle that must also be connected to PCB RF ground. |  |
| 6 | VEE | Supply Voltage -5V ± 10% |  |
| 7 | CTLB | See truth table and control voltage table. |  |
| 8 | CTLA | See truth table and control voltage table. | |



TTL Interface Circuit

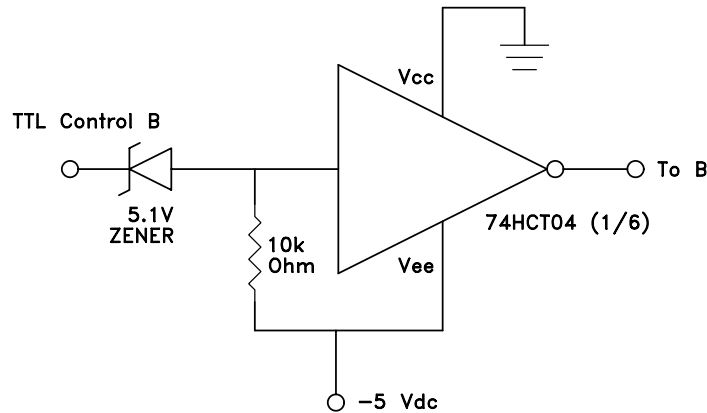
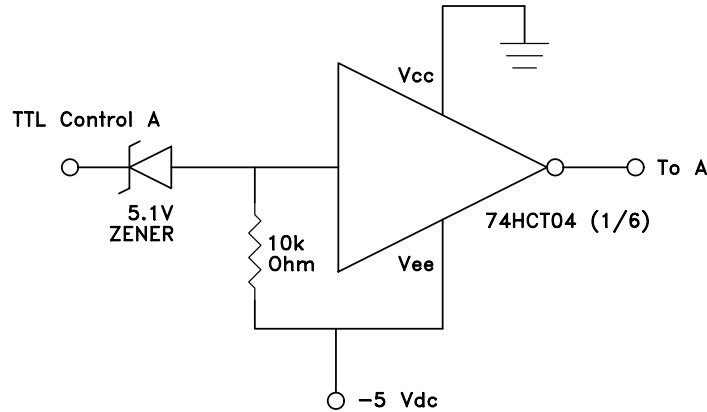



Evaluation PCB

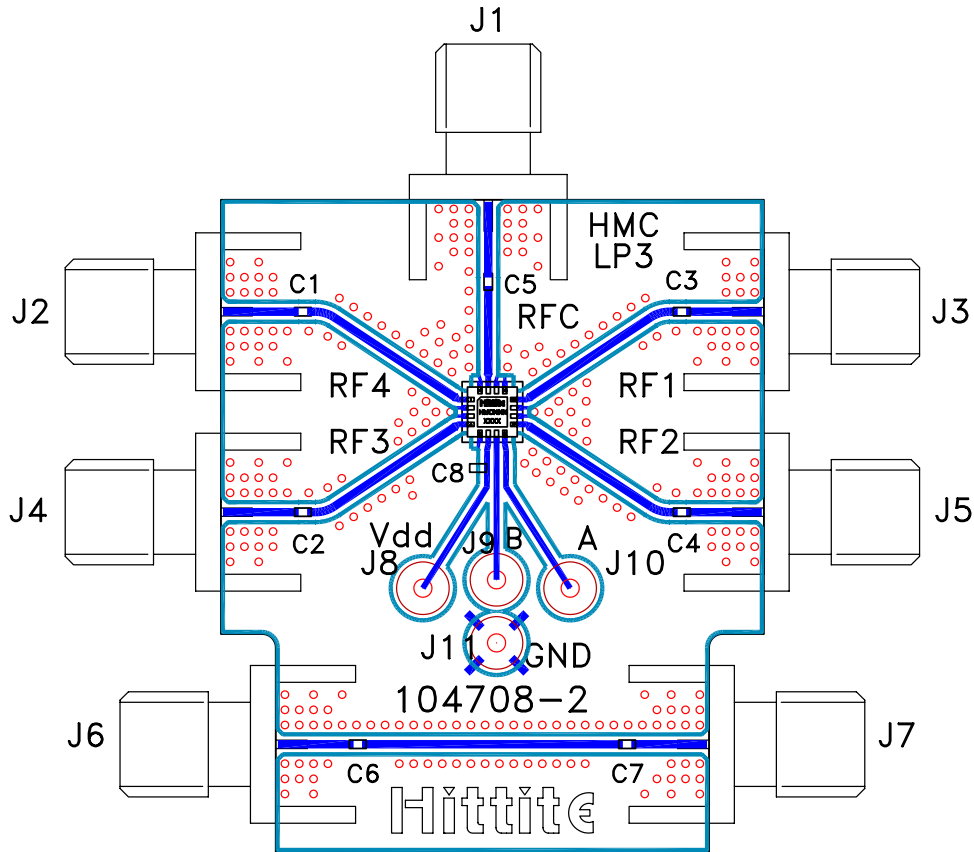

List of Materials for Evaluation PCB 105311 [1]

| Item | Description |
|----------|------------------------------------|
| J1 - J7 | PCB Mount SMA RF Connector |
| J8 - J11 | DC Pin |
| C1 - C7 | 0 ohm res, 0402 Pkg. [3] |
| C8 | 10k pF Capacitor, 0603 Pkg. |
| U1 | HMC344LP3 / HMC344LP3E SP4T Switch |
| PCB [2] | 104708 Evaluation PCB 1.29"x1.55" |

[1] Reference this number when ordering complete evaluation PCB

[2] Circuit Board Material: Rogers 4350

[3] Select and replace with a suitable capacitor value for applicable operating frequency range.

The circuit board used in the final application should be generated with proper RF circuit design techniques. Signal lines at the RF port should have 50 ohm impedance and the package ground leads and backside ground slug should be connected directly to the ground plane similar to that shown above. The evaluation circuit board shown above is available from Hittite Microwave Corporation upon request.